

UNIONE ACCADEMICA NAZIONALE

MATERIALI PER IL VOCABOLARIO
NEOSUMERICO
Vol. XVIII

TABLILLAS ADMINISTRATIVAS
NEOSUMERIAS
DE LA ABADÍA DE MONTSERRAT
(BARCELONA)

Copias Cuneiformes

di

Manuel Molina



BONSIGNORI EDITORE

ROMA 1993

UNIONE ACCADEMICA NAZIONALE
Materiali per il Vocabolario Neosumerico - Vol. XVIII

Serie diretta da G. Pettinato

TUTTI I DIRITTI RISERVATI



© By BONSIGNORI EDITORE, 1993
00152 Roma - Viale dei Quattro Venti 47

TABLILLAS ADMINISTRATIVAS
NEOSUMERIAS
DE LA ABADÍA DE MONTSERRAT (BARCELONA)

Copias Cuneiformes

PREFACIO

Durante mi estancia en Barcelona en 1989, tuve la ocasión de conocer, gracias a Miguel Civil, la colección de tablillas cuneiformes neosumerias de la Abadía de Montserrat. Desde entonces, mis numerosas visitas a este lugar contaron con la aprobación de los sucesivos abades del monasterio Dom Cassià Maria Just y Dom Sebastià Bardolet; a ellos y a toda la comunidad deseo agradecer su siempre afectuosa acogida. Una mención de especial reconocimiento va dirigida también al P. Guiu Camps, actual responsable del Museu Bíblic de Montserrat: su infinita amabilidad en todo momento, generosidad con su tiempo y disponibilidad para ayudarme en los muchos problemas de catalogación y localización de las tablillas han facilitado enormemente la tarea de edición de estos textos.

La consecución del trabajo encontró un posterior apoyo, ahora desde la Universidad de Murcia, con una subvención concedida por la Dirección General de Investigación Científica y Técnica del Ministerio de Educación y Ciencia en el marco del Programa Sectorial de Promoción General del Conocimiento.

Este mismo organismo, en cooperación con el Deutsche Akademische Austauschdienst, subvencionó igualmente una colaboración con Hartmut Waetzoldt (Universidad de Heidelberg) que ha tenido como objetivo el estudio de las improntas de cilindrosello en las tablillas de Ur III. A lo largo de las tres semanas que duró nuestra estancia en la Abadía (abril 1993), el Prof. H. Waetzoldt, además de la revisión e identificación de los sellos, realizó numerosas colaciones a mis copias que han contribuido en no poco a la realización de este volumen. Por ello, y por su experto asesoramiento en otros aspectos, le debo mi más profundo agradecimiento. Huelga decir que los errores vertidos en esta edición son sólo responsabilidad del que suscribe.

Por su aliento, apoyo y consejos, debo gratitud, asimismo, a los siguientes estudiosos: Miguel Civil, Giovanni Pettinato, Gregorio del Olmo, Joaquín Sanmartín, José Remesal, Antonino González, José M^a Blázquez y Fumi Karahashi.

Deseo expresar, finalmente, mi reconocimiento a Giovanni Pettinato, quien, con su habitual entusiasmo y empeño en la publicación del material epigráfico de la Tercera Dinastía de Ur, ha aceptado la inclusión de este volumen en la serie *Materiali per il Vocabolario Neosumerico* de la Unione Accademica Nazionale de Italia.

A Esther

ÍNDICE

Prefacio	p. 5
Dedicatoria	p. 7
Índice	p. 9
Introducción	p. 11
Abreviaturas	p. 13
Catálogo	p. 15
Concordancias	p. 31
Tablillas previamente editadas	p. 39
Copias	pl. I-CCLXIV

INTRODUCCIÓN

La colección de tablillas cuneiformes que actualmente se encuentra depositada en la Abadía de Montserrat fue adquirida por el P. Bonaventura Ubach¹ entre 1922 y 1923, junto con muchas otras antigüedades procedentes de Iraq, Irán, Anatolia, Siria-Palestina y Egipto destinadas al Museu Bíblic. Según anota el viajero en su diario², la compra de tablillas, cilindros, ladrillos de fundación, conos, un kudurru y una mina inscrita fue realizada según la siguiente secuencia:

- Bagdad, 26.9.22: "compra de una considerable cantidad de tablillas cuneiformes al sirio Semkheri".
- Bagdad, 12.1.23: "compra de una considerable cantidad de tablillas".
- Bagdad, 24.1.23: "compra de tablillas cuneiformes".
- Bagdad, 3-21.2.23: "compra de algunas tablillas y clavos cuneiformes y veinticuatro cilindros".
- Bagdad, 25.2.23: "compra de una mina real de procedencia desconocida, pero con una inscripción, varias tablillas cuneiformes y tres cilindros".
- Al Hillah, 28.2.23: "compra de algunos cilindros y algunas tablillas cuneiformes".
- An Nasiriyah, 4.3.23: "compra de un fragmento de kudurru".
- Bagdad, 12.3.23: "compra de un ladrillo con una inscripción".
- Bagdad, 13.3.23: "compra de tres tablillas cuneiformes".
- Bagdad, 15.3.23: "compra de tablillas cuneiformes, conos, etc. al sirio Semkheri".
- Basora, 16.4.23: "compra de un cilindro muy bien conservado".
- Basora, 25.4.23: "compra de dos ladrillos con inscripciones muy claras".
- Basora, 27.4.23: "compra de un ladrillo de Nabucodonosor del templo de Ur".
- An Nasiriyah, 29.4.23: "compra a un judío de diez tablillas cuneiformes, cien tablillas cuneiformes bien conservadas, fragmentos de otras doscientas y tres conos".
- An Nasiriyah, 29.4.23: "compra de cilindros de lapislázuli, tres cilindros (dos son de amatista y uno blanco de Gilgamesh³), cuatro cilindros al Sr. Elies Haddad y dos cilindros".
- Al Hillah, 30.4.23: "compra de una tablilla de Niffer y algunas de Hmeira".
- Nimrud, 15.5.23: "compra de un fragmento de ladrillo con inscripción".
- Bagdad, 30.5.23: "compra a un armenio de dos grandes tablillas cuneiformes y otras más pequeñas, y conos".

La colección entró en Montserrat el mismo 1923, y allí permaneció hasta comienzos de 1937, cuando, en plena Guerra Civil, 380 tablillas y 74 cilindros fueron llevados al Museo del Louvre de París por iniciativa de P. Bosch i Gimpera. Aquí estuvieron inicialmente al cuidado de L. Delaporte hasta que en marzo de 1947, concluida la Segunda Guerra Mundial, fueron devueltas a la Abadía por mediación de Mlle. Manneville, por aquel entonces conservadora adjunta del Museo del Louvre³.

¹ Sobre la vida y obra de este insigne bibliista, puede consultarse la biografía de R.M. Díaz i Carbonell, *Dom Bonaventura Ubach. L'Home, el monjo, el bibliista*, Barcelona 1962.

² La edición del diario de viaje de B. Ubach, de próxima aparición, está actualmente a cargo del P. Guiu Camps, a quien debo los datos que aquí se mencionan.

³ Un relato detallado de las vicisitudes por las que pasó la colección durante estos años puede encontrarse en R.M. Díaz i Carbonell, "La recuperació dels segells-cilindres i de les tauletes cuneiformes del Museu Bíblic", *Montserrat Bullett del Santuari* 31 (1991) 29-32.

El primer estudio de importancia realizado sobre las tablillas fue obra de N. Schneider⁴, quien se ocupó de la publicación de 390 textos sumerios de la Tercera Dinastía de Ur seleccionados entre los primeros 600 números de inventario del museo. Dicha edición sufrió una notable revisión por parte de L. Cagni⁵, quien, además de poner de relieve las virtudes y los defectos del volumen de Schneider y resolver parte de los problemas de catalogación, realizó un gran número de colaciones a sus copias.

El resto de los textos de la colección ha permanecido inédito⁶, excepto en el caso de algunos de carácter literario y léxico, de los que se ha ocupado principalmente M. Civil⁷, y en el de las tablillas de época sargónica⁸.

La presente edición abarca la totalidad de los textos administrativos de la Tercera Dinastía de Ur conservados en la Abadía de Montserrat, incluyendo aquellos previamente publicados por N. Schneider. En ella se proporciona el catálogo general y las copias de los textos; éstas han sido realizadas siguiendo las convenciones habituales en los trabajos de asiriología y aumentadas en un 30% sobre el tamaño real de la tablilla. En conjunto se han copiado 758 tablillas o fragmentos, a los que hay que añadir diez números de catálogo correspondientes a textos no copiados por encontrarse en muy deficiente estado de conservación (n^{os} 381, 452, 580, 619, 717, 721, 738, 763, 764 y 765), una bulla anepigráfica (n^o 655), una tablilla desaparecida (n^o 316 = AnOr 7 316) y dos grupos de pequeños fragmentos sin interés (n^{os} 753 y 754).

Transliteraciones e índices se reservan para un segundo volumen que aparecerá próximamente en la serie *Aula Orientalis - Supplementa* (Sabadell-Barcelona); este segundo libro contará también con un apéndice, realizado por H. Waetzoldt, en el que se estudian las improntas de cilindrosello de los textos.

Para la numeración de los documentos he considerado prioritario conservar la ofrecida por N. Schneider en los ya editados (por ej. n^o 1 = AnOr 7 1), con el fin de no complicar aún más el ya de por sí confuso mundo de las publicaciones de textos de Ur III. En las ocasiones en que alguna de las tablillas de AnOr 7 ha sido objeto de *join* con otro fragmento, se ha optado por la numeración más baja de esta edición; en el caso de que el segundo fragmento haya sido también publicado en AnOr 7, este último se ha eliminado del catálogo (por ej. n^o 332 = AnOr 7 332+333: se elimina *n^o 333 = AnOr 7 333). Esta premisa ha condicionado la organización de toda la edición e impedido publicar los textos ordenados por ciudades, datación, sellos o contenido. Así, las tablillas inéditas se han dispuesto a continuación de las ya publicadas por Schneider siguiendo estrictamente la secuencia de sus números de inventario (MM).

⁴ N. Schneider, *Die Drehem- und Djohatexte im Kloster Montserrat (Barcelona)*, *Analecta Orientalia* 7, Roma 1932.

⁵ L. Cagni, "Collazioni a N. Schneider, *Die Drehem- und Djoha-Texte im Kloster Montserrat (Barcelona)* (*Analecta Orientalia* 7), Roma 1932", *Oriens Antiquus* 22 (1983) 73-118.

⁶ Las cerca de 200 tablillas del II y I milenio a.C. se encuentran actualmente en estudio a cargo de J. Sanmartín (Universidad de Barcelona).

⁷ Una bibliografía completa de los textos ya editados podrá encontrarse en el catálogo general de las tablillas cuneiformes de la Abadía de Montserrat, realizado por J. Sanmartín y M. Molina, que se publicará próximamente en la revista *Aula Orientalis*.

⁸ M. Molina, "Tablillas sargónicas del Museo de Montserrat, Barcelona", *Aula Orientalis* (Fs. M. Civil) 9 (1991) 137-154. El texto n^o 5 editado en este artículo fue previamente publicado por Schneider (*AnOr* 7 372), erróneamente considerado como perteneciente a Ur III.

ABREVIATURAS

a.	Anverso
AnOr	Analecta Orientalia, Roma
AS	Año de reinado de Amar-Suen
AuOr	Aula Orientalis, Sabadell-Barcelona
D	Drehem
IS	Año de reinado de Ibbi-Suen
JCS	Journal of Cuneiform Studies, New Haven
L	Lagaš
MM	Números de inventario del Museo de la Abadía de Montserrat
OrSP	Orientalia Series Prior, Roma
r.	Reverso
ŠS	Año de reinado de Šu-Suen
U	Umma

CATÁLOGO¹

N° Texto	Bibliografía	MM	Datación	Prov.	Sello	Medidas
1	AnOr 7 1	23	Š30/vi/-	D		33x30x16
2	AnOr 7 2	33	Š36/ix/-	D		50x36x19
3	AnOr 7 3	44	Š39/v/-	D		38x30x17
4 ²	AnOr 7 4	107	Š42 ó AS6/vii ó x/-	D ²	S	53x41x28
5	AnOr 7 5	167	IS2/x/-	D	S	42x37x16
6	AnOr 7 6	64	Š44/ii/-	D		32x29x16
7	AnOr 7 7	58	Š44/ii/15	D		40x34x17
8	AnOr 7 8	62	Š44/vi/5,10	D		32x28x16
9	AnOr 7 9	77	Š46/x/-	D		36x31x18
10	AnOr 7 10	76	Š46/x/13 ó 23	D		39x34x18
11	AnOr 7 11	75	Š46/xii/-	D		35x31x16
12	AnOr 7 12	530	Š46/xii/-	D		39x32x17
13	AnOr 7 13	74	Š46/xii/4 ~ 10	D		44x34x18
14	AnOr 7 14	90	Š47/v/-	D		30x27x16
15	AnOr 7 15	89	Š47/ix/2	D		33x28x17
16	AnOr 7 16	84	Š47/i/-	D		25x21x13
17	AnOr 7 17	97	Š48/xii/-	D		51x38x20
18	AnOr 7 18	98	AS1/-/-	U		90x54x24
19	AnOr 7 19	99	AS1/vi/-	D		46x37x19
20	AnOr 7 20	219	AS1/x/29	D		26x24x14
21	AnOr 7 21	220	AS3/viii/17	D		29x24x13
22	AnOr 7 22	101	AS3/vii/-	D		32x28x16
23	AnOr 7 23	105	AS5/-/-	D	S	43x36x15
24	AnOr 7 24	541	AS5/iv/8	D		64x43x21
25	AnOr 7 25	114	AS8/ii/7	D		33x29x15
26	AnOr 7 26	111	AS8/x/-	D	S	36x42x17
27	AnOr 7 27	187	[]/vii/20	D	S	64x49x23
28	AnOr 7 28	125	ŠS2/iii/8	D	S	40x35x14
29	AnOr 7 29	213	AS3/iv/12	D		23x22x13
30	AnOr 7 30	121	ŠS2/v/-	D	S	42x36x15
31	AnOr 7 31	119	ŠS2/vi/9,10	D	S	44x37x18
32	AnOr 7 32	127	ŠS2/ix/8 ~ 26	D		46x38x18
33	AnOr 7 33	123	ŠS2/xi/-	D	S	39x37x15
34	AnOr 7 34	133	ŠS3/i/25	D	S	41x35x15
35	AnOr 7 35	132	ŠS3/vi/25,26	D	S	42x36x17
36	AnOr 7 36	135	ŠS3/viii/29	D	S	55x47x18
37	AnOr 7 37	75b	ŠS3/ix/-	D	S	40x36x14
38	AnOr 7 38	513	ŠS4/ii/15	D		38x34x16
39	AnOr 7 39	131	ŠS4/iii/-	D	S	40x36x16
40	AnOr 7 40	40	ŠS8/xi/-	D		39x33x16
41	AnOr 7 41	141	ŠS6/v/1 ~ 26	D		116x62x43
42	AnOr 7 42	39	ŠS8/viii/-	D		43x34x18
43	AnOr 7 43	147	ŠS7/x/2	D		38x36x18
44	AnOr 7 44	146	ŠS7/xi/2	D		78x48x21
45	AnOr 7 45	50	ŠS9/ix/-	D	S	44x39x17
46	AnOr 7 46	149	ŠS9/x/-	D	S	43x40x17
47	AnOr 7 47	156	ŠS9/xii/25	D	S	48x44x17
48	AnOr 7 48	162	IS1/iii/11	D	S	58x39x18

¹ Con un * se indican las tablillas o fragmentos no copiados por encontrarse en muy deficiente estado de conservación. Las medidas (en mm) corresponden, en su caso, a las dimensiones del fragmento conservado.

² Envoltorio cerrado.

Nº Texto	Bibliografía	MM	Datación	Prov.	Sello	Medidas
49	<i>AnOr</i> 7 49	160	IS1/vii/-	D	S	35x32x12
50 ³	<i>AnOr</i> 7 50	70	-/-/-	D'	S	43x59x17
51	<i>AnOr</i> 7 51	157	ŠS9/x/-	D	S	44x40x16
52	<i>AnOr</i> 7 52	24	Š32/xi ¹ /-	D		40x34x18
53	<i>AnOr</i> 7 53	25	Š33/ix/-	D		73x42x22
54	<i>AnOr</i> 7 54	545	Š35/-/-	U'		43x35x17
55	<i>AnOr</i> 7 55	29	Š35/vi/-	D		37x33x19
56	<i>AnOr</i> 7 56	28	Š35/x/-	D		37x33x18
57	<i>AnOr</i> 7 57	31	Š36/i/-	D		38x34x16
58	<i>AnOr</i> 7 58	30	Š36/i/-	D		36x33x18
59	<i>AnOr</i> 7 59	34	Š36/iv/-	D		33x30x15
60	<i>AnOr</i> 7 60	32	Š36/ix/1-2	D		51x39x19
61	<i>AnOr</i> 7 61	37	Š37/v/-	D		55x36x20
62	<i>AnOr</i> 7 62	38	Š37/vi/-	D		61x40x22
63	<i>AnOr</i> 7 63	43	Š40/iii/1	D		39x33x17
64	<i>AnOr</i> 7 64	191	Š41/ix/6,10	D		39x34x17
65	<i>AnOr</i> 7 65	46	Š40/ix/30	D		52x37x19
66	<i>AnOr</i> 7 66	42	Š40/x/28	D		59x39x19
67	<i>AnOr</i> 7 67	45	Š41/ii/20	D		37x30x16
68	<i>AnOr</i> 7 68	47	Š41/ii/4	D		54x37x18
69	<i>AnOr</i> 7 69	48	Š41/vii/2	D		37x31x16
70	<i>AnOr</i> 7 70	55	Š43/ii/11 ~ 17	D		48x34x16
71	<i>AnOr</i> 7 71	56	Š43/x/4,5	D		44x35x19
72	<i>AnOr</i> 7 72	67	Š45/vii/10,15	D		58x40x19
73	<i>AnOr</i> 7 73	71	Š45/ix/13	D		62x38x21
74	<i>AnOr</i> 7 74	65	Š45/ix/30	D		34x33x18
75	<i>AnOr</i> 7 75	82	Š46/viii/27	D		38x30x18
76	<i>AnOr</i> 7 76	79	Š46/xi/8,9	D		41x33x18
77	<i>AnOr</i> 7 77	81	Š46/xi/15	D		43x34x19
78	<i>AnOr</i> 7 78	72	Š46/xii/-	D		35x30x18
79	<i>AnOr</i> 7 79	201	Š46/xii/9	D		40x34x18
80	<i>AnOr</i> 7 80	78	Š46/xii/13,14	D		37x31x18
81	<i>AnOr</i> 7 81	432	Š47/iii/15	D		33x32x19
82	<i>AnOr</i> 7 82	95	Š47/ii/14	D		29x27x15
83	<i>AnOr</i> 7 83	92	Š47/vi/19,21	D		56x38x18
84	<i>AnOr</i> 7 84	83	Š47/vi/22	D		34x27x16
85	<i>AnOr</i> 7 85	85	Š47/ix/-	D		32x28x16
86	<i>AnOr</i> 7 86	91	Š47/xi/7	D		32x28x15
87	<i>AnOr</i> 7 87	87	Š47/xi/7	D		43x33x18
88	<i>AnOr</i> 7 88	52	Š43/i/15,19,22	D		39x33x17
89	<i>AnOr</i> 7 89	36	Š37/viii/-	D		40x34x19
90	<i>AnOr</i> 7 90	181	-/vii/14	D		37x32x18
91	<i>AnOr</i> 7 91	51	Š41/vii/-	D		37x29x16
92	<i>AnOr</i> 7 92	524	Š34/ii/-	D		40x36x18
93 ⁴	<i>AnOr</i> 7 93	221	AS6/v-xii/18	D	S	47x49
94	<i>AnOr</i> 7 94	96	Š48/vi/11	D		56x36x20
95	<i>AnOr</i> 7 95	268	Š48/ix/29	D		48x35x18
96	<i>AnOr</i> 7 96	215	AS2/iv/1	D		28x25x13
97	<i>AnOr</i> 7 97	552	AS2/v/23	D		45x37x18
98	<i>AnOr</i> 7 98	562	AS2/viii/-	D		39x32x17
99	<i>AnOr</i> 7 99	103	AS4/v/6	D		78x47x21
100	<i>AnOr</i> 7 100	145	ŠS7/x [~] /1 ~ [1]	D		128x55x23

³ Etiqueta triangular con orificio transversal para cuerda.

⁴ Bulla con orificios para cuerda.

N° Texto	Bibliografía	MM	Datación	Prov.	Sello	Medidas
101	<i>AnOr</i> 7 101	117	ŠS1/xii/-	D	S	45x37x17
102	<i>AnOr</i> 7 102	124	ŠS2/v/8	D		49x38x19
103	<i>AnOr</i> 7 103	120	ŠS2/vii/-	D	S	37x33x14
104	<i>AnOr</i> 7 104	143	ŠS8/x/16,17,25	D	S	71x47x20
105	<i>AnOr</i> 7 105	500	ŠS9/-/15	D	S	68x46x20
106	<i>AnOr</i> 7 106	155	ŠS9 ⁷ /x/1	D	S	40x38x16
107	<i>AnOr</i> 7 107	152	ŠS9/x/4	D	S	60x45x18
108	<i>AnOr</i> 7 108	154	ŠS9/x/1 ~ 30	D		137x111x25
109	<i>AnOr</i> 7 109	153	ŠS9/xi/6,14	D	S	49x43x18
110	<i>AnOr</i> 7 110	202	[]/18	D	S	49x38x19
111	<i>AnOr</i> 7 111	203	[]	D		47x34x20
112	<i>AnOr</i> 7 112	151	ŠS9/v/-	L ⁷	S	45x42x19
113	<i>AnOr</i> 7 113	217	AS4 ó 9/xi/9	D		23x22x11
114	<i>AnOr</i> 7 114	26	Š35/-/ (vi-viii)	D		51x37x20
115	<i>AnOr</i> 7 115	35	Š36/v vii ó ix/-	D		36x33x16
116	<i>AnOr</i> 7 116	446	Š36/vi/-	U		33x32x16
117	<i>AnOr</i> 7 117	460	Š44/vi/20	D		27x23x13
118	<i>AnOr</i> 7 118	455	Š44/x/8	D		25x22x12
119	<i>AnOr</i> 7 119	451	Š47/iv ó v/26	D		26x23x14
120	<i>AnOr</i> 7 120	218	ŠS4/ii/20	D		24x22x12
121	<i>AnOr</i> 7 121	457	Š47/i/2 ó 3	D		33x28x17
122 ⁵	<i>AnOr</i> 7 122	94	Š47/iv/-	D	S	tab.: 29x25x15 env.: 38x34x27
123	<i>AnOr</i> 7 123	458	Š47/vii/11	D		22x20x12
124	<i>AnOr</i> 7 124	564	Š48/ii/-	D		32x30x16
125	<i>AnOr</i> 7 125	206b	AS1/-/	U		54x47x20
126	<i>AnOr</i> 7 126	436	AS2/iii/6	D		25x23x14
127	<i>AnOr</i> 7 127	109	Š42 ó AS6/i-xiii/-	D		35x33x15
128	<i>AnOr</i> 7 128	102	AS4/viii/-	D		44x37x20
129	<i>AnOr</i> 7 129	165	AS5/-/	D	S	45x38x14
130 ⁶	<i>AnOr</i> 7 130	108	AS6/x/-	D	S	tab.: 39x36x15 env.: 49x44x23
131	<i>AnOr</i> 7 131	212	AS6/xi/10	D		22x20x12
132	<i>AnOr</i> 7 132	110	AS6-7/-/	D		43x36x19
133	<i>AnOr</i> 7 133	214	AS7/i/22	D		22x20x12
134	<i>AnOr</i> 7 134	459	AS7/v/10[(±x)]	D		24x22x13
135	<i>AnOr</i> 7 135	113	AS8/vii/-	D		40x35x18
136	<i>AnOr</i> 7 136	211	AS8/vii/26	D		19x17x10
137	<i>AnOr</i> 7 137	445	AS8/xi/12	D		23x21x12
138	<i>AnOr</i> 7 138	452	ŠS2/ix/15	D		26x23x13
139	<i>AnOr</i> 7 139	448	AS2/xi/1	D		27x25x13
140	<i>AnOr</i> 7 140	177	ŠS8/v/-	D	S(2)	45x38x15
141	<i>AnOr</i> 7 141	163	IS1/xi/-	D	S	43x39x15
142	<i>AnOr</i> 7 142	216	[]/ii ó iii/13	D		21x28x12
143	<i>AnOr</i> 7 143	444	AS7/iii/4	D		18x16x09
144 ⁷	<i>AnOr</i> 7 144 (= MM 54)	54 + 1101	Š43/xii/-	D	S	tab.: 31x28x16 env.: 37x39x23
145	<i>AnOr</i> 7 145	88	Š47/xi/-	D		41x36x16
146	<i>AnOr</i> 7 146	555	AS9/viii/-	U	S	41x40x14
147	<i>AnOr</i> 7 147	27	Š34/v/-	D		48x38x21
148	<i>AnOr</i> 7 148	59	Š44/viii/17	D		40x34x18

⁵ Tablilla y envoltorio.

⁶ Tablilla y envoltorio.

⁷ Tablilla y envoltorio.

N° Texto	Bibliografía	MM	Datación	Prov.	Sello	Medidas
149	AnOr 7 149	57	Š44/viii/-	D		37x31x16
150	AnOr 7 150	93	Š47/vi/20	D		46x37x19
151	AnOr 7 151	73	Š46/xi/21	D		34x29x16
152	AnOr 7 152	86	Š47/vii/-	D		39x31x18
153	AnOr 7 153	41	Š38/x/-	D		36x31x17
154	AnOr 7 154	491	AS9/-/ (AS8/xii)	D		151x61x29
155	AnOr 7 155	69	Š45 ó AS2/x/-	D		56x39x19
156	AnOr 7 156	193	AS4 5 8 9 ó IS4/[]	U ¹		92x51x27
157	AnOr 7 157	205	-/vii/-	D ¹		40x36x17
158	AnOr 7 158	60	Š44/x/-	D		45x34x16
159	AnOr 7 159	148	ŠS9/xii/[]	D	S	60x41x19
160	AnOr 7 160	159	ŠS.../x ó xi/1 ~ 25	D	S	113x84x28
161	AnOr 7 161	192	AS9 ¹ /[]	D	S	72x45x16
162	AnOr 7 162	422	Š42 ó AS6/x/18	D		35x41x19
163	AnOr 7 163	540	[]	U		41x54x20
164	AnOr 7 164	543	[]	U	S	42x40x10
165	AnOr 7 165	527	[]	D		50x40x11
166	AnOr 7 166	115	-/-/ (AS9/viii, ŠS1/viii, ŠS2/iv)	D		91x47x25
167	AnOr 7 167	49	Š41/vi/-	D		41x34x17
168	AnOr 7 168	512	Š30 ¹ ó IS5 ¹ /viii/-	U	S	34x34x18
169	AnOr 7 169	358	Š35/iv/-	U	S	40x37x14
170	AnOr 7 170	581	Š34/vii/-	U	S	33x34x13
171	AnOr 7 171	533	Š36/ii/-	U	S	39x41x15
172	AnOr 7 172	572	Š36/viii/-	U	S	38x40x17
173	AnOr 7 173	456	Š39/ix/-	U		30x30x16
174	AnOr 7 174	172	Š44/xii/[]	U	S	37x35x15
175	AnOr 7 175	339	AS2/-/-	U	S	35x37x15
176	AnOr 7 176	556	AS2/-/-	U		40x36x17
177	AnOr 7 177	376	AS1/-/-	U		36x33x16
178	AnOr 7 178	437	AS9/xiii/-	U	S	34x35x15
179	AnOr 7 179	206	Š38/x/-	U	S	41x43x16
180	AnOr 7 180	139	ŠS5/ix/-	U		36x30x17
181	AnOr 7 181	340	ŠS5/ix xi ó xii/3	U		48x41x18
182	AnOr 7 182	178	[]/ii/-	U	S	34x39x15
183	AnOr 7 183	392	[]/vii/-	U		30x30x16
184	AnOr 7 184	412	Š34/xii/-	U	S	38x43x18
185	AnOr 7 185	346	Š36/-/-	U	S	44x48x17
186	AnOr 7 186	390	Š36/i/-	U	S	33x41x13
187	AnOr 7 187	381	ŠS4/-/-	U	S	43x40x19
188	AnOr 7 188	408	Š40/-/-	U	S	34x34x15
189	AnOr 7 189	419	Š40/-/- (xii-vii)	U	S	39x40x16
190	AnOr 7 190	385	AS6/-/-	U	S	42x35x17
191 ⁸	AnOr 7 191	536	Š46/vi/-	U	S	35x37x22
192	AnOr 7 192	518	Š46 ó AS3/viii/-	U	S	39x41x19
193	AnOr 7 193	549	Š48/xii/-	U	S	44x42x18
194	AnOr 7 194	505	Š48/iii/21	U	S	59x48x19
195	AnOr 7 195	559	AS1/xii/-	U	S	47x42x17
196	AnOr 7 196	223	AS1/-/-	U	S	42x42x15
197	AnOr 7 197	343	AS1/-/- (v,[])	U	S	42x47x22
198	AnOr 7 198	365	AS2/-/-	U	S	64x48x20
199	AnOr 7 199	529	AS2/-/-	U	S	41x42x16
200	AnOr 7 200	570	AS2/-/-	U	S	40x42x17
201	AnOr 7 201	443	AS2/ix xi ó xii/-	U		56x37x19

⁸ Bulla con orificios para cuerda.

N° Texto	Bibliografía	MM	Datación	Prov.	Sello	Medidas
202	<i>AnOr</i> 7 202	516	AS3/-/-	U	S	40x40x15
203	<i>AnOr</i> 7 203	547	AS4/-/-	U		38x34x19
204	<i>AnOr</i> 7 204	447	AS4/-/-	U	S	46x40x18
205	<i>AnOr</i> 7 205	359	Š43 AS4 5 8 9 6 IS2/-/-	U	S	45x44x16
206	<i>AnOr</i> 7 206	409	AS5/-/-	U	S	53x50x19
207	<i>AnOr</i> 7 207	104	AS5/ix/-	U	S	38x36x14
208	<i>AnOr</i> 7 208	207	AS7/-/-	U	S	43x38x15
209	<i>AnOr</i> 7 209	551	ŠS1/xi/-	U	S	42x44x16
210	<i>AnOr</i> 7 210	544	AS7/-/-	U	S	48x42x18
211	<i>AnOr</i> 7 211	176	AS7/iv/-	U	S	45x42x17
212	<i>AnOr</i> 7 212	398	AS7/-/- {ix-xii}	U	S	48x39x17
213	<i>AnOr</i> 7 213	112	AS8/-/-	U	S	40x45x19
214	<i>AnOr</i> 7 214	168	AS9/-/-	U	S	41x35x17
215	<i>AnOr</i> 7 215	169	AS9/-/-	U	S	67x46x21
216	<i>AnOr</i> 7 216	391	AS9/[?]/-	U	S	52x40x17
217	<i>AnOr</i> 7 217	403	AS9/-/-	U	S	43x36x14
218	<i>AnOr</i> 7 218	379	AS9/-/-	U	S	35x39x15
219	<i>AnOr</i> 7 219	503	AS9/-/- {vii,v,[]}	U		76x45x25
220	<i>AnOr</i> 7 220	229	ŠS1/-/-	U	S	52x49x20
221	<i>AnOr</i> 7 221	380	ŠS1/-/-	U	S	64x48x20
222	<i>AnOr</i> 7 222	514	ŠS1/-/-	U	S	46x43x15
223	<i>AnOr</i> 7 223	548	ŠS1/-/-	U	S	50x42x18
224	<i>AnOr</i> 7 224	450	ŠS1/-/-	U	S	49x44x20
225	<i>AnOr</i> 7 225	411	ŠS1/vi/-	U	S	42x35x14
226	<i>AnOr</i> 7 226	144	ŠS6/-/- {v-xii, i-xii}	U	S	58x46x19
227	<i>AnOr</i> 7 227	434	ŠS1/vii/-	U	S	37x36x15
228	<i>AnOr</i> 7 228	126	ŠS1/ix - ŠS2/xii	U	S	50x45x16
229	<i>AnOr</i> 7 229	129	ŠS2/-/-	U	S	105x78x30
230	<i>AnOr</i> 7 230	349	ŠS2/-/-	U	S	43x41x15
231	<i>AnOr</i> 7 231	550	ŠS2/-/-	U	S	45x42x16
232	<i>AnOr</i> 7 232	593	ŠS3/-/-	U	S	69x48x19
233	<i>AnOr</i> 7 233	368	ŠS3/-/-	U	S	46x40x18
234	<i>AnOr</i> 7 234	421	ŠS3/-/-	U	S	46x41x17
235	<i>AnOr</i> 7 235	498	ŠS3/iii/-	U	S	42x46x17
236	<i>AnOr</i> 7 236	232	ŠS3/vii/-	U	S	42x39x15
237	<i>AnOr</i> 7 237	600	ŠS4/-/-	U	S	57x47x17
238	<i>AnOr</i> 7 238	136	ŠS4/-/-	U	S	40x45x15
239	<i>AnOr</i> 7 239	138	ŠS4/-/-	U	S	85x86x28
240	<i>AnOr</i> 7 240	494	ŠS4/-/-	U	S	44x44x16
241	<i>AnOr</i> 7 241	394	ŠS4/vii/-	U	S	55x54x21
242 ⁹	<i>AnOr</i> 7 242	140	ŠS5/vii/-	U	S	36x34x14
243	<i>AnOr</i> 7 243	402	ŠS9/-/-	U	S	51x68x22
244	<i>AnOr</i> 7 244	410	ŠS7/-/-	U		42x36x17
245	<i>AnOr</i> 7 245	407	ŠS7/xi/-	U		35x33x16
246	<i>AnOr</i> 7 246	158	ŠS6 6 8/-/-	U	S(2)	52x40x19
247	<i>AnOr</i> 7 247 (= MM 166)	166+182	IS3/-/-	U	S	125x80x26
248	<i>AnOr</i> 7 248	537	[]/-/-	U	S	46x44x16
249	<i>AnOr</i> 7 249	228	[]/-/-	U	S	39x36x15
250	<i>AnOr</i> 7 250	338	ŠS8/-/-	U	S	56x46x20
251	<i>AnOr</i> 7 251	355	ŠS6 6 8/[]	U	S	40x40x14
252	<i>AnOr</i> 7 252	389	[]	U	S	47x44x18

⁹ Bulla con orificios para cuerda.

N° Texto	Bibliografía	MM	Datación	Prov.	Sello	Medidas
253	<i>AnOr</i> 7 253	397	[]	U	S	51x39x21
254	<i>AnOr</i> 7 254	406	[]	U	S	40x43x22
255	<i>AnOr</i> 7 255	435	AS1 ŠS1 6 IS1/[]	U		40x37x16
256	<i>AnOr</i> 7 256	161	IS1/-/	U		88x51x21
257	<i>AnOr</i> 7 257	356	Š47 6 48/i/15	D'		50x41x20
258	<i>AnOr</i> 7 258	578	[]/xii/-	L		25x28x18
259	<i>AnOr</i> 7 259	499	AS8/-/ {AS5-8}	U		51x42x20
260	<i>AnOr</i> 7 260	373	ŠS4/[] {ŠS3}	U		55x44x20
261	<i>AnOr</i> 7 261	453	-/viii/-	U		31x27x14
262	<i>AnOr</i> 7 262	130	ŠS2/iii/-	U		88x74x25
263	<i>AnOr</i> 7 263	519	ŠS1-3/-/	U	S	45x45x18
264	Deimel <i>OrSP</i> 2 (1920) 56 <i>AnOr</i> 7 264	171	[]	U		65x133x31
265	<i>AnOr</i> 7 265	354	AS7/vii/-	U	S	47x43x16
266	<i>AnOr</i> 7 266	579	Š48/ix/-	U	S	39x37x15
267	<i>AnOr</i> 7 267	224	Š36/-/	U	S	39x42x18
268	<i>AnOr</i> 7 268	357	AS1/vii/-	U	S	44x41x17
269	<i>AnOr</i> 7 269	416	ŠS2/-/ {v'}	U	S	43x41x17
270	<i>AnOr</i> 7 270	378	ŠS8/-/	U	S	55x47x16
271	<i>AnOr</i> 7 271	420	[]/viii 6 ix/-	D'		47x43x22
272	<i>AnOr</i> 7 272	573	Š33/iv 6 vi/-	U	S	47x36x14
273	<i>AnOr</i> 7 273	116	AS6/-/	U	S	37x36x14
274	<i>AnOr</i> 7 274	461	ŠS3/-/	U	S	43x48x17
275	<i>AnOr</i> 7 275	384	ŠS1/vi/30	U		33x32x13
276	<i>AnOr</i> 7 276	424	AS2/ii/8	U		35x35x18
277	<i>AnOr</i> 7 277	336	ŠS1/-/ {i-ix}	U	S	45x38x22
278	<i>AnOr</i> 7 278	345	-/-/	?		42x38x12
279	<i>AnOr</i> 7 279	569	ŠS3/iii/-	U		47x39x19
280	<i>AnOr</i> 7 280	517	Š47/x/-	U		29x40x19
281	<i>AnOr</i> 7 281	588	[]	U		88x99x32
282	<i>AnOr</i> 7 282	68	Š45 46 AS2 6 3/-/	U		82x74x32
283	<i>AnOr</i> 7 283	179	[]	U	S	35x35x27
284	<i>AnOr</i> 7 284	184	[]	U		54x73x29
285	<i>AnOr</i> 7 285	188	[]	L'		135x91x39
286	<i>AnOr</i> 7 286	225	ŠS6/viii/21	U	S	71x43x20
287	<i>AnOr</i> 7 287	377	Š35/vii/-	U	S	39x35x13
288	<i>AnOr</i> 7 288	428	AS3/iii/[?]	U	S	40x39x17
289	<i>AnOr</i> 7 289	493	AS7/vii'/-	U	S	64x43x22
290	<i>AnOr</i> 7 290	596	-/iii/3	L		41x49x26
291	<i>AnOr</i> 7 291	387	Š35/xii/-	U	S	33x37x13
292	<i>AnOr</i> 7 292	414	AS3/vi'/[?]	U	S	40x42x17
293	<i>AnOr</i> 7 293	567	ŠS2/-/ {iii-viii}	U	S	40x39x16
294	<i>AnOr</i> 7 294	577	[]	U'		43x45x19
295	<i>AnOr</i> 7 295	186	[]	U o L		55x60x25
296	<i>AnOr</i> 7 296	190	[]	U		102x64x25
297	<i>AnOr</i> 7 297	521	Š43/-/	U	S	45x35x17
298	<i>AnOr</i> 7 298	375	Š32 6 33/[]	U	S	38x49x17
299	<i>AnOr</i> 7 299	565	ŠS1/-/	U	S	40x40x15
300	<i>AnOr</i> 7 300	563	Š45 6 AS2/-/	U	S	47x46x16
301	<i>AnOr</i> 7 301	508	[]	U		142x65x26
302	<i>AnOr</i> 7 302	496	AS1/-/ {i-vi,[]}	U		65x47x22
303	Deimel <i>OrSP</i> 2 (1920) 55 <i>AnOr</i> 7 303	174	ŠS3/xiii/-	U		125x107x30
304	<i>AnOr</i> 7 304	341	ŠS9/vi/[(x+)]7	U		23x31x12
305	<i>AnOr</i> 7 305	425	ŠS9/ix/22	U		32x27x12

N° Texto	Bibliografía	MM	Datación	Prov.	Sello	Medidas
306	AnOr 7 306	454	ŠS3/iii/21	U		33x31x15
307	AnOr 7 307	405	-/-/-	U [†]		29x37x18
308	AnOr 7 308	535	[]	U [†]	S	66x44x14
309	AnOr 7 309	388	ŠS9/iii/-	U		39x34x15
310	AnOr 7 310	383	-/-/17,18	U		36x33x16
311	AnOr 7 311	198	[]	U		100x65x27
312	AnOr 7 312	61	Š44/-/-	L [†]		45x38x21
313	AnOr 7 313	197	-/-/-	U		137x83x25
314	AnOr 7 314	534	ŠS2 6 ŠS7/[]	U	S	46x40x13
315	AnOr 7 315	185	[]	U		83x57x23
316 ^o	AnOr 7 316	509	[] { [], AS9, ŠS1, ŠS2, [], AS8, []-ŠS1, ŠS1-ŠS5, ŠS6-[] }	U		-----
317	AnOr 7 317	582	IS3///- (IS2)	?		39x33x16
318	AnOr 7 318	400	Š46/ix/[?]	U		27x35x16
319	AnOr 7 319	594	[]/[]/-	U		61x44x19
320	AnOr 7 320	417	[]	U		56x46x18
321	AnOr 7 321	495	AS2/-/-	U [†]		63x47x19
322	AnOr 7 322	522	-/-/-	U		38x35x18
323	AnOr 7 323	511	ŠS6/-/- {i}	U	S	54x47x18
324	AnOr 7 324	553	AS8/-/- {iv-v}	U	S	41x39x15
325	AnOr 7 325	393	ŠS4/-/-	U	S	45x49x17
326	AnOr 7 326	344	ŠS4 6 5/[]	U		37x50x21
327	AnOr 7 327	164	AS5/xii/-	U		27x25x15
328	AnOr 7 328	180	ŠS4/-/-	U	S	36x34x14
329	AnOr 7 329	195	[]	U		109x80x24
330	AnOr 7 330	80	[] {Š45-46,[] }	U		38x49x21
331	AnOr 7 331	199	[]	U		64x86x26
332	AnOr 7 332 (= MM 204) y 333(=MM 208)	204+208	[]	U [†]		59x58x23
	AnOr 7 333 (v. n° 332)					
334	AnOr 7 334	386	[]	U [†]		44x40x20
335	AnOr 7 335	395	[]	U	S	65x55x20
336	AnOr 7 336	396	[] {AS1}	?		51x51x21
337	AnOr 7 337	399	[]	U		41x43x20
338	AnOr 7 338	142	ŠS6/v/-	U		36x34x17
339	AnOr 7 339	183	ŠS2 6 3/-/-	U		69x53x19
340	AnOr 7 340	372	[]	U		94x53x28
341	AnOr 7 341	415	[]	U	S	68x45x21
342	AnOr 7 342	426	[]	U	S	43x43x18
343	AnOr 7 343 (= MM 427) y 357(=MM 364)	364+374+427+ 658+843+933	[]	U		142x115x18
344	AnOr 7 344	430	AS5/[]	U	S	31x41x21
345	AnOr 7 345	429	[]	U		48x27x23
346	AnOr 7 346	433	AS5/[]	D		29x30x15
347	AnOr 7 347	438	Š44/-/-	U	S	48x41x15
348	AnOr 7 348	592	[]	U	S	73x47x24
349	AnOr 7 349	561	Š44/vii/-	U	S	44x40x13
350	AnOr 7 350	449	AS7/x/7	U		29x25x13
351	AnOr 7 351	350	ŠS8/iii/10[(+x)]	U	S	43x48x18

¹⁰ Tablilla actualmente desaparecida.

Nº Texto	Bibliografía	MM	Datación	Prov.	Sello	Medidas
352	<i>AnOr</i> 7 352	333	§§2/-/ {i,iv,vi,viii,[]}	U	S	72x44x17
353	<i>AnOr</i> 7 353	370	[]	?		22x43x17
354	<i>AnOr</i> 7 354	351	[]	U		49x32x20
355	<i>AnOr</i> 7 355	352	[]	L ²		38x35x13
356	<i>AnOr</i> 7 356	361	§§4/x/-	U ²		41x38x17
	<i>AnOr</i> 7 357 (v. n.º 343)					
358	<i>AnOr</i> 7 358	366	[]	U ²		35x32x15
359	<i>AnOr</i> 7 359	369	[]	L		45x38x14
360	<i>AnOr</i> 7 360	371	-/-	U		52x51x22
361	<i>AnOr</i> 7 361	382	AS2/[]	U		55x42x21
362	<i>AnOr</i> 7 362	334	[]	U		47x45x13
363	<i>AnOr</i> 7 363	335	[]	?		42x47x22
364	<i>AnOr</i> 7 364	342	§§3/v/-	U	S	44x42x14
365	<i>AnOr</i> 7 365	347	AS8/-/-	U	S	49x38x16
366	<i>AnOr</i> 7 366	520	[]	U	S	40x44x17
367	<i>AnOr</i> 7 367	557	§§4/-/-	U	S	59x46x18
368	<i>AnOr</i> 7 368 (= MM 568)	568 + 798	[entre §48-§§1]	U	S	96x52x26
369	<i>AnOr</i> 7 369	574	§§4/xiii/-	U	S	44x38x15
370	<i>AnOr</i> 7 370	584	§48/-/-	U		38x37x19
371	<i>AnOr</i> 7 371	200	-/-	U		80x50x28
	<i>AnOr</i> 7 372 ¹¹					
		497				
373	<i>AnOr</i> 7 373	122	§§3/v/-	U	S	49x43x18
374	<i>AnOr</i> 7 374	196	[]	U		105x100x42
375	<i>AnOr</i> 7 375	189	[]	U	S	97x52x22
376	<i>AnOr</i> 7 376	53	IS2/xii/5,22	D	S	80x45x21
377	<i>AnOr</i> 7 377	137	[] {§§2,4,5,[]}	U ²		82x52x19
378	<i>AnOr</i> 7 378	539	AS7/-/-	U	S	49x46x17
379	<i>AnOr</i> 7 379	546	§48/-/-	U	S	39x39x16
380.1	<i>AnOr</i> 7 380.1	528	AS8/-/-	U	S	53x43x20
380.2	<i>AnOr</i> 7 380.2	531	AS8/-/-	U		82x47x23
380.3	<i>AnOr</i> 7 380.3	576	AS2/iii ² /[?]	L ²		23x26x17
380.4	<i>AnOr</i> 7 380.4	209	§§5/i/10	L		30x26x11
380.5	<i>AnOr</i> 7 380.5	363	[]	U		49x50x23
380.6	<i>AnOr</i> 7 380.6	337	§48/-/-	?	S	48x43x18
380.7	<i>AnOr</i> 7 380.7	222	AS8/-/-	U	S	43x41x16
380.8	<i>AnOr</i> 7 380.8	226	-/vi/-	U o L	S	35x40x15
380.9	<i>AnOr</i> 7 380.9	360	[]	U		41x38x19
380.10	<i>AnOr</i> 7 380.10	348	[]	U		35x29x18
*381 ¹²	<i>AnOr</i> 7 381	490	[]	?		80x50x21
382	-----	63	§44/[]	D		25x30x16
383	-----	63b	§§3 6 45/viii/8 ¹	D		31x20x06
384	-----	173	§§4/-/-	U	S	39x42x14
385	-----	175	§§7/vii/[x +]3	D	S	44x40x19
386	-----	210	[]	?		58x45x22
387	-----	227	-/-	U	S	37x40x12
388	-----	231	[]	L		180x115x43
389	-----	353	[]	L		34x35x17
390	-----	362	§§7/[]	U	S	37x39x13
391	-----	404	-/viii/-	L		43x27x16
392	-----	413	[]	U		68x64x12

¹¹ Tablilla sargónica erróneamente incluida por N. Schneider como texto de Ur III. Reeditada por M. Molina, *AuOr* 9 (1991) 142-145 (n.º 5).

¹² Tablilla actualmente muy destruida. El reverso es anepigráfico, atravesado longitudinalmente por una raya de tachadura.

N° Texto	Bibliografía	MM	Datación	Prov.	Sello	Medidas
393	-----	431	-/vi/10	L		25x28x17
394	-----	439	-/-/-	L		50x42x20
395	-----	482	Š34/x/-	U		37x34x16
396	-----	483	ŠS3/-/-	U	S	49x44x16
397	-----	484	ŠS2/-/-	U	S	54x45x20
398	-----	485	[]	U		52x43x21
399	-----	486	ŠS1/-/-	U	S	39x40x15
400	-----	487a	Š44/viii/-	U	S	68x41x21
401	-----	489	ŠS2/v/-	U	S	47x45x17
402	-----	515	-/xii/-	L		52x37x19
403	-----	525+611b	[]/vii ó x/-	U	S	130x80x25
404	-----	532	[]	U	S	80x62x24
405	-----	580	[]	U ^r		37x29x14
406	-----	585	Š44/vii/-	U		40x34x18
407	-----	586+587	ŠS4/-/-	U	S	53x37x15
408	-----	601	Š39/vii ó x/[?]	?	S	39x39x12
409	-----	602b	[]	U		85x46x27
410	-----	603	[]	U ^r		38x50x16
411	-----	604	Š46 ó AS3/viii/-	U	S	40x39x18
412	-----	605b	AS4 ó 5/[]	U		65x42x20
413	-----	606	[]	U	S	40x42x17
414	-----	607	[]	U	S	52x42x18
415	-----	608(+) ⁸³¹	[]	U		55x71x33 (MM 608) 61x63x27 (MM 831)
416	-----	610	[]	?		64x45x24
417	Civil JCS 32 (1980) 169	611	Š34/-/-	U	S	38x38x14
418	-----	612	AS9/-/-	U ^r	S	43x38x15
419	-----	613	ŠS9/-/-	U	S	41x41x15
420	-----	614	ŠS7/-/-	U	S	40x40x15
421	-----	615	ŠS.../-/-	U	S	36x42x15
422	-----	616	ŠS4/i/-	U ^r	S	42x38x15
423	-----	617	ŠS3/-/-	U	S	44x43x15
424	-----	618	AS2/[]/-	U	S	40x38x14
425	-----	619	Š43/-/-	U	S	41x44x17
426	-----	620	ŠS8/-/-	U	S	45x41x16
427	-----	621	AS8/-/-	U	S	45x41x16
428	-----	622	Š44/-/-	U	S	43x44x19
429	-----	623	Š33/vi/-	U	S	34x38x16
430	-----	624	Š38/i/-	U	S	42x46x17
431	-----	625	Š45 ó AS2/xii/-	U	S	38x39x15
432	-----	626	ŠS3/ix/-	D		45x56x23
433	-----	627	AS9/-/-	U	S	42x40x13
434	-----	628	AS9/-/-	U	S	42x38x16
435	-----	629+948	[]	U	S	75x58x21
436	-----	630+653	ŠS.../-/-	U	S	70x47x20
437	-----	631	[]	U ^r		45x47x20
438	-----	632	Š47/x/-	U	S	37x42x13
439	-----	633	[]/-/-	U	S	42x39x19
440	-----	634	IS3/-/- (i-iii)	U	S	44x38x17
441	-----	635	AS3/v/1	U	S	38x44x17
442	-----	636	ŠS1/-/-	U	S	41x48x17
443	-----	637	[]	U		43x45x22
444	-----	638	ŠS1/ix/-	U	S	43x38x14
445	-----	639	Š32/ii ó iii/-	U	S	35x39x14
446	-----	640	AS1/viii/-	U	S	38x38x13
447	-----	641	ŠS8/-/-	U	S	40x39x15

N° Texto	Bibliografía	MM	Datación	Prov.	Sello	Medidas
448	-----	642	Š43/-/-	U	S	47x48x20
449	-----	643	ŠS1/i/-	U	S	48x38x17
450	-----	644	ŠS4/-/18	U	S	39x39x14
451	-----	645	Š41/xi/-	U	S	43x39x16
*452	-----	646	[entre Š42-Š48]	U	S	35x37x14
453	-----	647	ŠS1/[]	U	S	32x48x18
454	-----	648	ŠS.../-/-	U	S	35x44x18
455	-----	649	Š35/v/-	U	S	43x38x16
456	-----	650	[]/-/-	U	S	39x39x15
457	-----	651	Š36/viii/-	U	S	37x41x15
458	-----	652	ŠS9/-/-	U	S	36x37x17
459	-----	654	ŠS9/-/-	U	S	35x34x13
460	-----	655	[]/iii/-	U	S	38x42x16
461	-----	656	AS8 [?] /viii/-	U	S	47x41x18
462	-----	657	Š38/ix/[?]	U	S	40x36x16
463	-----	659	ŠS1/-/-	U	S	42x44x15
464	-----	660	AS9/[]	U	S	29x39x14
465	-----	661	[]	U	S	44x34x10
466	-----	662	?/xii/-	U	S	29x36x15
467	-----	663	ŠS1/viii/-	U	S	41x37x19
468	-----	664+1138	AS7/-/-	U	S	53x48x11
469	-----	665	?/-/-	U	S	38x36x13
470	-----	666	AS9/-/-	U	S	41x39x16
471	-----	667	AS5/x/-	U	S	37x39x15
472	-----	668	ŠS.../i 6 iii/-	U	S	47x37x17
473	-----	669	ŠS2/-/-	U	S	46x46x19
474	-----	670	AS5/x/-	U	S	44x30x14
475	-----	671	AS4/-/-	U	S	32x44x16
476	-----	672	[]	U	S	51x48x21
477	-----	673	ŠS... 6 IS.../-/-	U	S	38x41x20
478	-----	674	Š38/vi/-	U	S	32x40x18
479	-----	675	AS9/-/- {[]-xii}	U	S	38x35x14
480	-----	676	ŠS1/vii/24,27,[]	D	S	55x41x19
481	-----	677	ŠS9/-/-	U	S	45x40x17
482	-----	678	ŠS1 [?] /-/-	U	S	47x47x16
483	-----	679	ŠS1/xi/-	U	S	58x42x21
484	-----	680	Š48/-/-	U	S	41x40x16
485	-----	681	ŠS3/-/-	U	S	47x43x16
486	-----	682	Š46/-/-	U	S	37x38x14
487	-----	683	AS6/-/-	U	S	37x46x14
488	-----	684	ŠS6/iv/-	U	S	42x43x15
489	-----	685	AS8/-/-	U	S	39x37x11
490	-----	686	AS9/-/-	U	S	44x42x16
491	-----	687	Š45 6 AS2/-/-	U	S	47x44x19
492	-----	688	Š48/-/-	U	S	39x40x14
493	-----	689	AS9/-/-	U	S	41x42x15
494	-----	690	ŠS3/v/-	U	S	41x39x15
495	-----	691	ŠS.../xiii/2	U	S	35x37x15
496	-----	692	AS1/v/-	U	S	42x42x15
497	-----	693	ŠS.../-/-	U	S	38x41x16
498	-----	694	Š35/-/-	U	S	37x42x18
499	-----	695	AS2/-/-	U	S	44x46x16
500	-----	696	Š35/-/-	U	S	45x38x19
501	-----	697b	[]/iii/-	U	S	40x35x17
502	-----	698	AS7/-/- {ix-xii,ix-xi}	U	S	51x42x17
503	-----	699	ŠS7/xii/-	U	S	45x43x19

N° Texto	Bibliografía	MM	Datación	Prov.	Sello	Medidas
504	-----	700	[]	U	S	62x47x22
505	-----	701	[]/iii/- {iv}	U	S	50x44x19
506	-----	702	[]/iii/15-viii/8}	U	S	40x45x17
507	-----	703	ŠS4/-/-	U	S	43x41x17
508	-----	704	ŠS1 6 IS1/[]	U	S	38x39x12
509	-----	705	AS9/-/-	U	S	45x40x15
510	-----	706	Š41/vi/-	U	S	39x37x16
511	-----	707	AS1/-/-	U		29x29x15
512	-----	708	[]	U		21x38x12
513	-----	709	AS9/-/-	U	S	38x44x16
514	-----	710a	Š40/xii/-	U	S	39x37x14
515	-----	710b	AS7/xii/-	U		85x50x21
516	-----	711a	ŠS4/-/-	U	S	44x44x15
517	-----	711b	AS3/-/-	U	S	41x31x22
518	-----	712+731b	[]	?		60x54x24
519	-----	713	AS8/xi/17	U	S	28x37x05
520	-----	714	IS3/-/-	U	S	48x40x08
521	-----	715	[]	U		43x36x15
522	-----	716+910	-/-/-	U		80x46x20
523	-----	718	ŠS6/[]	?		47x46x20
524	-----	719	[]/ix/-	U		28x35x20
525	-----	720	[]	?		50x45x22
526	-----	721	Š46/[]	?	S	27x36x16
527	-----	722	[]	U	S	30x42x11
528	-----	723	-/-/-	U		46x36x22
529	-----	724	Š46/v/[?]	U		35x36x16
530	-----	725	[]	U		31x37x20
531	-----	730	[]/ii/-	U		23x33x15
532	-----	733	[]	U	S	32x40x16
533	-----	734	AS9/[]	?		41x34x15
534	-----	735	[]	?		47x26x23
535	-----	736	AS9/viii/-	U		54x37x18
536	-----	737	[]	U		56x40x19
537	-----	738	[]	L'		40x34x17
538	-----	739+1071	[]	?		78x36x24
539	-----	740	AS3/-/-	U		34x31x16
540	-----	741	AS8/[]	U		49x44x20
541	-----	742	[]	U	S	45x43x12
542	-----	743	ŠS4/[]	?		42x38x14
543	-----	744	[]	U	S	45x40x17
544	-----	745	ŠS1/-/-	U	S	41x41x13
545	-----	746	AS3/viii/- {ix xi 6 xii-viii}	U	S	66x41x19
546	-----	747	AS5/iv/[?]	U	S	38x42x14
547	-----	748	Š45 6 AS2/-/-	U	S	39x39x25
548	-----	749	AS8/iv/-	U	S	46x41x16
549	-----	750	ŠS2/-/-	U	S	42x42x18
550	-----	751	[]/[]/9	D		44x37x19
551	-----	752	Š38/vii/-	U	S	54x44x19
552	-----	753	Š41/-/-	U	S	46x36x14
553	-----	754	AS3/-/-	U		35x26x16
554	-----	755	[]	U	S	34x40x14
555	-----	756	AS6/-/-	U	S	39x41x15
556	-----	757	ŠS7/-/-	U	S	52x34x18
557	-----	758	ŠS5/x/-	U	S	56x42x16
558	-----	759	AS9/-/-	U	S	42x41x15
559	-----	760	AS9/-/-	U	S	50x39x20

N° Texto	Bibliografía	MM	Datación	Prov.	Sello	Medidas
560	-----	761	AS3/iii/-	U	S	41x38x17
561	-----	762	Š45/ii ó iii/-	U	S	36x38x12
562	-----	763	[]/-/-	U	S	49x48x17
563	-----	764	-/-/- (AS9/ii)	U	S	44x41x16
564	-----	765	ŠS8/-/- {iii-[]}	U	S	50x46x17
565	-----	766	AS3/iv/-	U	S	40x37x17
566	-----	767	ŠS2/-/-	U	S	53x46x19
567	-----	768	ŠS3/v/-	U	S	44x44x15
568	-----	769	ŠS9/xi/-	U	S	34x40x14
569	-----	770	ŠS7/[]	U	S	35x37x13
570	-----	771	AS4/-/-	U	S	40x36x15
571	-----	772	ŠS2/-/-	U	S	38x37x15
572	-----	773	-/-/-	U	S	39x34x14
573	-----	774	AS7/vi/-	U	S	42x38x17
574	-----	775	ŠS3/vi/5	U	S	37x37x14
575	-----	776	Š47 48 ó AS1/[]	U	S	34x44x18
576	-----	777	[]	U	S	31x38x16
577	-----	778	ŠS1/[]	U	S	26x41x15
578	-----	779+788	Š46/-/-	U	S	42x43x17
579	-----	780	[]	U	S	34x38x14
*580	-----	781	[]	U	S	32x26x13
581	-----	782	AS2/-/-	U	S	35x37x25
582	-----	783	[]/-/-	U	S	33x21x14
583	-----	784	[]	?	S	27x35x15
584	-----	785	[]	U	S	55x44x17
585	-----	786	ŠS6/-/-	U	S	33x40x14
586	-----	787	[]	U	S	60x42x16
587	-----	789	[]/-/- {iv-[]}	U	S	35x39x18
588	-----	790	AS9/-/-	U	S	40x40x15
589	-----	791	ŠS1/vii/-	U	S	45x30x16
590	-----	792	ŠS2/-/-	U	S	37x37x15
591	-----	793	ŠS5 ó 6/-/-	U	S	37x36x15
592	-----	794	[]	U	S	55x34x16
593	-----	795	Š35/[]	U	S	38x44x18
594	-----	796	AS7/-/-	U	S	34x32x14
595	-----	797	-/-/-	U	S	44x32x17
596	-----	799	[después de ŠS3]/viii ó ix/-	D	S	42x39x15
597	-----	800	ŠS3/-/- {i-xiii,viii-xiii}	U	S	49x44x17
598	-----	802	[]	?		37x44x19
599	-----	803	AS3 4 ŠS8 ó 9/ii ³ /-	U	S	52x52x13
600	-----	805	AS7/vi/[?]	U	S	34x41x16
601	-----	806	AS6/[]	U	S	25x43x20
602	-----	807	Š34/x/-	U	S	34x35x17
603	-----	827	[]	L		50x43x23
604	-----	834	[]	?		41x55x20
605	-----	836+953(+)957	AS9/-/-	U		52x50x27 (MM 836+953) 21x50x19 (MM 957)
606	-----	838	ŠS2 ó 3/-/-	U	S	69x27x18
607	-----	844	AS7/-/-	L		52x67x21
608 ¹³	-----	848	-/vi/-	L	S	tab.: 36x31x14 env.: 48x44x27
609	-----	851	ŠS1/i/-	U	S	42x42x16
610	-----	852	[]/-/-	U	S	50x39x18
611	-----	853	ŠS4/-/-	U	S	43x41x17

¹³ Tablilla y envoltorio.

N° Texto	Bibliografía	MM	Datación	Prov.	Sello	Medidas
612	-----	858a	[]	U		76x60x32
613	-----	867	[]	?		85x60x27
614	-----	869+1131	[]	U		81x59x20
615	-----	888	AS4/-/	U	S	58x42x18
616	-----	891	[]	U ¹		61x53x21
617	-----	895b	[]/vi/-	U	S	42x41x13
618	-----	906	[]	?		43x47x21
*619	-----	907	[]	?		33x32x13
620	-----	908	[]	?		48x32x18
621	-----	909	[]	?		40x40x18
622	-----	911	[]	?		35x31x18
623	-----	912	[]	?		65x49x22
624	-----	913	[]	?		37x32x25
625	-----	915	Š46 ó AS3/[]	L ¹		40x38x19
626	-----	917	[]	L ¹		61x47x17
627	-----	918	[entre AS4-ŠS5]	U	S	39x50x20
628	-----	920	ŠS1/vi/-	D		41x30x16
629	-----	921	ŠS...-/	U	S	45x33x19
630	-----	922	AS2/[]	U ¹		29x37x19
631	-----	923	Š42 ó AS6/iii/-	D		35x33x16
632	-----	924	[]/[]/21	L		30x43x21
633 ¹⁴	-----	926	-/-/	U		32x33x17
634	-----	927	[]	?		28x38x20
635	-----	928(+)943	[]	U ¹		21x42x18 (MM 928) 62x39x14 (MM 943)
636	-----	930	[]	U	S	81x46x13
637	-----	931	[]	?		25x48x17
638	-----	932	[]	U ¹		50x54x18
639	-----	934	[]	U	S	37x39x17
640	-----	935	ŠS2/iv/-	U		33x46x20
641	-----	938	[]	U		77x82x30
642	-----	939	[]	L ¹		37x33x14
643	-----	940	[]	?		45x34x21
644	-----	941	AS8/-/	U		27x36x16
645	-----	942	[]	?		34x40x21
646	-----	944	[]	?		49x56x13
647	-----	945	AS4 ó AS9/v/30	D		32x29x14
648	-----	946	[]	?		33x45x14
649	-----	947	ŠS7/[]	?		39x41x18
650	-----	949	Š43/-/	U		37x36x17
651	-----	951	[]	U		76x44x21
652	-----	954	[]	U ¹		68x27x15
653	-----	955	AS3/i/21	D		35x34x17
654	-----	956	[]	U	S	48x45x21
655 ¹⁵	-----	958	-/-/	?	S	40x48
656	-----	959	[]	?		30x38x20
657	-----	960	AS5/vi/-	U	S	39x38x20
658	-----	961	[]	?		40x37x18
659	-----	962	[]	?		45x30x21
660	-----	963	[]	?		35x45x22
661	-----	964	AS2/[]	?		26x37x16
662	-----	965	AS4/[]	?		34x31x15

¹⁴ Etiqueta con orificios para cuerda.

¹⁵ *Bulla* anepigráfica sellada (escena de introducción a la divinidad) con impresiones interiores de cuerda.

N° Texto	Bibliografía	MM	Datación	Prov.	Sello	Medidas
663	-----	966	[]	U	S	46x34x14
664	-----	967	Š34/-/-	U		40x30x14
665	-----	968	[]	U	S	40x39x21
666	-----	969	[]	U		40x30x16
667	-----	970	AS4/-/-	?		27x40x21
668 ¹⁶	-----	991	AS1/-/-	L	S	tab.: 31x28x14 env.: 47x41x29
669	-----	992	AS4 6 9/[]/3	U	S	53x45x13
670	-----	993	Š34/iii/-	L		34x34x15
671	-----	994	ŠS7/-/-	U		40x35x17
672	-----	995	ŠS9/ix/-	U	S	57x47x19
673	-----	996	ŠS5/vi/-	U	S	35x34x15
674	-----	997	AS5/[]	U	S	41x41x19
675	-----	998	AS2 6 3/[]	U	S	51x40x09
676	-----	999	ŠS1 ⁹ /-/-	U	S	42x38x15
677	-----	1000	ŠS8/-/-	U	S	40x45x15
678	-----	1001	ŠS7/viii/-	U	S	49x37x17
679	-----	1002	ŠS1/-/-	U	S	41x38x23
680	-----	1004	AS3/-/- {v-vii}	U	S	39x38x16
681	-----	1005	[]	L		40x45x23
682	-----	1006	ŠS2 ⁹ /-/-	U	S	47x39x18
683	-----	1008	AS5/-/-	?		38x36x18
684	-----	1009	AS1/-/-	U	S	40x45x18
685	-----	1010	Š35/-/-	U	S	35x39x14
686	-----	1011	AS2/xiii/-	U	S	40x40x15
687	-----	1050	Š46/-/-	U ⁹		30x28x15
688	-----	1052	[]/iv/20	D		30x26x14
689	-----	1053	ŠS9/xii/[?]	U	S	29x43x19
690	-----	1054	AS2 6 3/ii/20[(+x)]	U		33x31x15
691	-----	1056	ŠS9/[]	U	S	33x44x17
692	-----	1057	AS1 ŠS1 6 IS1/[]	U ⁹	S	40x36x15
693	-----	1058	[]/-/-	U	S	33x43x17
694	-----	1060	ŠS2 6 8/-/-	U	S	32x34x15
695	-----	1061	ŠS.../vi/[?]	?		35x33x14
696	-----	1062	Š39/[?]/-	U	S	40x36x14
697	-----	1064	[]	?		34x36x19
698	-----	1065	[]	U	S	36x31x16
699	-----	1066	AS7/[]	U	S	35x34x14
700	-----	1067	ŠS9/-/-	U	S	39x39x13
701	-----	1068	ŠS8/[]	U	S	32x38x13
702	-----	1070	[]	U		32x41x23
703	-----	1074	Š44 6 IS3/[]	U	S	20x34x14
704	-----	1081	ŠS9/xi/-	U	S	38x38x17
705	-----	1083	AS5 ⁹ /-/-	U	S	42x38x17
706	-----	1084	[]	U	S	44x41x18
707	-----	1085	AS4/-/-	U	S	42x40x11
708	-----	1086	ŠS3/[]	U	S	41x38x14
709	-----	1087	[]	?	S	41x44x14
710	-----	1092	AS1/[]	?		32x33x15
711	-----	1093	[]	?		37x41x21
712	-----	1097	[]	U	S	26x42x16
713	-----	1099	Š33/[]	?	S	26x47x15
714	-----	1100	AS9/[]	U	S	38x39x17
715	-----	1103	AS8/iv 6 v/[]	D	S	34x30x11

¹⁶ Tablilla y envoltorio.

N° Texto	Bibliografía	MM	Datación	Prov.	Sello	Medidas
716	-----	1104	ŠS9/ii ó iv/[?]	D	S	30x30x17
*717	-----	1105	[]	?		31x33x14
718	-----	1106	Š41/[]	?	S	28x38x17
719	-----	1107	[]	U	S	27x42x11
720	-----	1108	[]	U		41x45x13
*721	-----	1109	[]	?		32x30x17
722	-----	1110	[]	U	S	43x21x20
723	-----	1111	AS3/xi/-	U	S	34x40x17
724	-----	1112	[]	U	S	25x38x18
725	-----	1113	Š32 33 44 45 AS6 ó 7/iv/[?]	U	S	29x45x15
726	-----	1116	-/-/-	U	S	37x39x17
727	-----	1117	[]	?		48x40x13
728	-----	1118	AS4 ŠS6 ó 8/-/-	U	S	38x42x15
729	-----	1119	AS4/vi/[?]	U		27x30x10
730	-----	1120	AS9/-/-	U	S	43x47x16
731	-----	1121	[]	U	S	42x42x15
732	-----	1122	[]	L ¹⁷	S	40x40x14
733	-----	1123	[]/[]/6	U	S	38x37x14
734	-----	1124	[]	?		35x34x18
735	-----	1125	ŠS1/ix/-	U	S	42x36x16
736	-----	1126	[]	?		33x51x23
737	-----	1128	[]	?	S	51x42x18
*738	-----	1129	[]	?	S	48x38x15
739	-----	1130	Š37/[]	U	S	29x27x12
740	-----	1136	[]	U	S	45x40x18
741	-----	1137	ŠS8/ix/-	U	S	47x47x12
742	-----	1139	[]	L		50x48x30
743	-----	1141	ŠS8/viii/-	U	S	50x42x16
744	-----	1142	ŠS4/xii/-	U	S	48x43x15
745	-----	1143	[]	U	S	39x36x11
746	-----	1144	AS8/-/-	?	S	40x40x13
747	-----	1146	ŠS6/[]	U	S	71x49x23
748	-----	1149	ŠS8/-/-	U	S	48x40x15
749	-----	1151	[]	U	S	53x46x09
750	-----	1152	Š36/i/-	U	S	40x42x13
751	-----	1155	[]	L ¹⁷		34x36x11
752	-----	1156	[]	L ¹⁷		65x34x26
753 ¹⁷	-----	1157	-----	--		-----
754 ¹⁸	-----	1158	-----	--		-----
755	-----	1159	[]	?		50x31x13
756	-----	1160	ŠS2 ó 8/viii/-	U	S	37x37x13
757	-----	1161	ŠS9/ii/-	U	S	40x32x12
758	-----	1162	Š45 ó AS2/x/-	U	S	37x37x12
759	-----	1163	ŠS1/v/[?]	U	S	40x40x13
760	-----	1164	[]/xiii/-	U	S	40x25x12
761	-----	1165	Š41/vi-[]/-	U	S	35x40x12
762	-----	1166	AS5/-/-	U	S	50x37x14
*763	-----	1167	[]	?		-----
*764	-----	1168	[]	?		-----
*765	-----	1169	[]	?		-----

¹⁷ 34 pequeños fragmentos con restos de impronta de sello.

¹⁸ 40 pequeños fragmentos sin impronta de sello.

CONCORDANCIAS

MM	N° Texto	Bibliografía	MM	N° Texto	Bibliografía
23	1	AnOr 7 1	75	11	AnOr 7 11
24	52	AnOr 7 52	75b	37	AnOr 7 37
25	53	AnOr 7 53	76	10	AnOr 7 10
26	114	AnOr 7 114	77	9	AnOr 7 9
27	147	AnOr 7 147	78	80	AnOr 7 80
28	56	AnOr 7 56	79	76	AnOr 7 76
29	55	AnOr 7 55	80	330	AnOr 7 330
30	58	AnOr 7 58	81	77	AnOr 7 77
31	57	AnOr 7 57	82	75	AnOr 7 75
32	60	AnOr 7 60	83	84	AnOr 7 84
33	2	AnOr 7 2	84	16	AnOr 7 16
34	59	AnOr 7 59	85	85	AnOr 7 85
35	115	AnOr 7 115	86	152	AnOr 7 152
36	89	AnOr 7 89	87	87	AnOr 7 87
37	61	AnOr 7 61	88	145	AnOr 7 145
38	62	AnOr 7 62	89	15	AnOr 7 15
39	42	AnOr 7 42	90	14	AnOr 7 14
40	40	AnOr 7 40	91	86	AnOr 7 86
41	153	AnOr 7 153	92	83	AnOr 7 83
42	66	AnOr 7 66	93	150	AnOr 7 150
43	63	AnOr 7 63	94	122	AnOr 7 122
44	3	AnOr 7 3	95	82	AnOr 7 82
45	67	AnOr 7 67	96	94	AnOr 7 94
46	65	AnOr 7 65	97	17	AnOr 7 17
47	68	AnOr 7 68	98	18	AnOr 7 18
48	69	AnOr 7 69	99	19	AnOr 7 19
49	167	AnOr 7 167	101	22	AnOr 7 22
50	45	AnOr 7 45	102	128	AnOr 7 128
51	91	AnOr 7 91	103	99	AnOr 7 99
52	88	AnOr 7 88	104	207	AnOr 7 207
53	376	AnOr 7 376	105	23	AnOr 7 23
54+1101	144	AnOr 7 144 (= MM 54)	107	4	AnOr 7 4
55	70	AnOr 7 70	108	130	AnOr 7 130
56	71	AnOr 7 71	109	127	AnOr 7 127
57	149	AnOr 7 149	110	132	AnOr 7 132
58	7	AnOr 7 7	111	26	AnOr 7 26
59	148	AnOr 7 148	112	213	AnOr 7 213
60	158	AnOr 7 158	113	135	AnOr 7 135
61	312	AnOr 7 312	114	25	AnOr 7 25
62	8	AnOr 7 8	115	166	AnOr 7 166
63	382	-----	116	273	AnOr 7 273
63b	383	-----	117	101	AnOr 7 101
64	6	AnOr 7 6	119	31	AnOr 7 31
65	74	AnOr 7 74	120	103	AnOr 7 103
67	72	AnOr 7 72	121	30	AnOr 7 30
68	282	AnOr 7 282	122	373	AnOr 7 373
69	155	AnOr 7 155	123	33	AnOr 7 33
70	50	AnOr 7 50	124	102	AnOr 7 102
71	73	AnOr 7 73	125	28	AnOr 7 28
72	78	AnOr 7 78	126	228	AnOr 7 228
73	151	AnOr 7 151	127	32	AnOr 7 32
74	13	AnOr 7 13	129	229	AnOr 7 229

MM	N° Texto	Bibliografía	MM	N° Texto	Bibliografía
130	262	AnOr 7 262	188	285	AnOr 7 285
131	39	AnOr 7 39	189	375	AnOr 7 375
132	35	AnOr 7 35	190	296	AnOr 7 296
133	34	AnOr 7 34	191	64	AnOr 7 64
135	36	AnOr 7 36	192	161	AnOr 7 161
136	238	AnOr 7 238	193	156	AnOr 7 156
137	377	AnOr 7 377	195	329	AnOr 7 329
138	239	AnOr 7 239	196	374	AnOr 7 374
139	180	AnOr 7 180	197	313	AnOr 7 313
140	242	AnOr 7 242	198	311	AnOr 7 311
141	41	AnOr 7 41	199	331	AnOr 7 331
142	338	AnOr 7 338	200	371	AnOr 7 371
143	104	AnOr 7 104	201	79	AnOr 7 79
144	226	AnOr 7 226	202	110	AnOr 7 110
145	100	AnOr 7 100	203	111	AnOr 7 111
146	44	AnOr 7 44	204+208	332	AnOr 7 332 (= MM 204) y 333 (= MM 208)
147	43	AnOr 7 43			
148	159	AnOr 7 159	205	157	AnOr 7 157
149	46	AnOr 7 46	206	179	AnOr 7 179
151	112	AnOr 7 112	206b	125	AnOr 7 125
152	107	AnOr 7 107	207	208	AnOr 7 208
153	109	AnOr 7 109	209	380.4	AnOr 7 380.4
154	108	AnOr 7 108	210	386	-----
155	106	AnOr 7 106	211	136	AnOr 7 136
156	47	AnOr 7 47	212	131	AnOr 7 131
157	51	AnOr 7 51	213	29	AnOr 7 29
158	246	AnOr 7 246	214	133	AnOr 7 133
159	160	AnOr 7 160	215	96	AnOr 7 96
160	49	AnOr 7 49	216	142	AnOr 7 142
161	256	AnOr 7 256	217	113	AnOr 7 113
162	48	AnOr 7 48	218	120	AnOr 7 120
163	141	AnOr 7 141	219	20	AnOr 7 20
164	327	AnOr 7 327	220	21	AnOr 7 21
165	129	AnOr 7 129	221	93	AnOr 7 93
166+182	247	AnOr 7 247 (= MM 166)	222	380.7	AnOr 7 380.7
167	5	AnOr 7 5	223	196	AnOr 7 196
168	214	AnOr 7 214	224	267	AnOr 7 267
169	215	AnOr 7 215	225	286	AnOr 7 286
171	264	Deimel OrSP 2 (1920) 56 AnOr 7 264	226	380.8	AnOr 7 380.8
172	174	AnOr 7 174	227	387	-----
173	384	-----	228	249	AnOr 7 249
174	303	Deimel OrSP 2 (1920) 55 AnOr 7 303	229	220	AnOr 7 220
175	385	-----	231	388	-----
176	211	AnOr 7 211	232	236	AnOr 7 236
177	140	AnOr 7 140	268	95	AnOr 7 95
178	182	AnOr 7 182	333	352	AnOr 7 352
179	283	AnOr 7 283	334	362	AnOr 7 362
180	328	AnOr 7 328	335	363	AnOr 7 363
181	90	AnOr 7 90	336	277	AnOr 7 277
183	339	AnOr 7 339	337	380.6	AnOr 7 380.6
184	284	AnOr 7 284	338	250	AnOr 7 250
185	315	AnOr 7 315	339	175	AnOr 7 175
186	295	AnOr 7 295	340	181	AnOr 7 181
187	27	AnOr 7 27	341	304	AnOr 7 304
			342	364	AnOr 7 364
			343	197	AnOr 7 197

MM	N° Texto	Bibliografía	MM	N° Texto	Bibliografía
344	326	AnOr 7 326	400	318	AnOr 7 318
345	278	AnOr 7 278	402	243	AnOr 7 243
346	185	AnOr 7 185	403	217	AnOr 7 217
347	365	AnOr 7 365	404	391	-----
348	380.10	AnOr 7 380.10	405	307	AnOr 7 307
349	230	AnOr 7 230	406	254	AnOr 7 254
350	351	AnOr 7 351	407	245	AnOr 7 245
351	354	AnOr 7 354	408	188	AnOr 7 188
352	355	AnOr 7 355	409	206	AnOr 7 206
353	389	-----	410	244	AnOr 7 244
354	265	AnOr 7 265	411	225	AnOr 7 225
355	251	AnOr 7 251	412	184	AnOr 7 184
356	257	AnOr 7 257	413	392	-----
357	268	AnOr 7 268	414	292	AnOr 7 292
358	169	AnOr 7 169	415	341	AnOr 7 341
359	205	AnOr 7 205	416	269	AnOr 7 269
360	380.9	AnOr 7 380.9	417	320	AnOr 7 320
361	356	AnOr 7 356	419	189	AnOr 7 189
362	390	-----	420	271	AnOr 7 271
363	380.5	AnOr 7 380.5	421	234	AnOr 7 234
364+374+ 427+658+ 843+933	343	AnOr 7 343 (= MM 427) y 357 (= MM 364)	422	162	AnOr 7 162
365	198	AnOr 7 198	424	276	AnOr 7 276
366	358	AnOr 7 358	425	305	AnOr 7 305
368	233	AnOr 7 233	426	342	AnOr 7 342
369	359	AnOr 7 359	428	288	AnOr 7 288
370	353	AnOr 7 353	429	345	AnOr 7 345
371	360	AnOr 7 360	430	344	AnOr 7 344
372	340	AnOr 7 340	431	393	-----
373	260	AnOr 7 260	432	81	AnOr 7 81
375	298	AnOr 7 298	433	346	AnOr 7 346
376	177	AnOr 7 177	434	227	AnOr 7 227
377	287	AnOr 7 287	435	255	AnOr 7 255
378	270	AnOr 7 270	436	126	AnOr 7 126
379	218	AnOr 7 218	437	178	AnOr 7 178
380	221	AnOr 7 221	438	347	AnOr 7 347
381	187	AnOr 7 187	439	394	-----
382	361	AnOr 7 361	443	201	AnOr 7 201
383	310	AnOr 7 310	444	143	AnOr 7 143
384	275	AnOr 7 275	445	137	AnOr 7 137
385	190	AnOr 7 190	446	116	AnOr 7 116
386	334	AnOr 7 334	447	204	AnOr 7 204
387	291	AnOr 7 291	448	139	AnOr 7 139
388	309	AnOr 7 309	449	350	AnOr 7 350
389	252	AnOr 7 252	450	224	AnOr 7 224
390	186	AnOr 7 186	451	119	AnOr 7 119
391	216	AnOr 7 216	452	138	AnOr 7 138
392	183	AnOr 7 183	453	261	AnOr 7 261
393	325	AnOr 7 325	454	306	AnOr 7 306
394	241	AnOr 7 241	455	118	AnOr 7 118
395	335	AnOr 7 335	456	173	AnOr 7 173
396	336	AnOr 7 336	457	121	AnOr 7 121
397	253	AnOr 7 253	458	123	AnOr 7 123
398	212	AnOr 7 212	459	134	AnOr 7 134
399	337	AnOr 7 337	460	117	AnOr 7 117
			461	274	AnOr 7 274
			482	395	-----

MM	N° Texto	Bibliografía	MM	N° Texto	Bibliografía
483	396	-----	551	209	AnOr 7 209
484	397	-----	552	97	AnOr 7 97
485	398	-----	553	324	AnOr 7 324
486	399	-----	555	146	AnOr 7 146
487a	400	-----	556	176	AnOr 7 176
489	401	-----	557	367	AnOr 7 367
490	381	AnOr 7 381	559	195	AnOr 7 195
491	154	AnOr 7 154	561	349	AnOr 7 349
493	289	AnOr 7 289	562	98	AnOr 7 98
494	240	AnOr 7 240	563	300	AnOr 7 300
495	321	AnOr 7 321	564	124	AnOr 7 124
496	302	AnOr 7 302	565	299	AnOr 7 299
497		AnOr 7 372 (sarg.)	567	293	AnOr 7 293
498	235	AnOr 7 235	568+798	368	AnOr 7 368 (= MM 568)
499	259	AnOr 7 259	569	279	AnOr 7 279
500	105	AnOr 7 105	570	200	AnOr 7 200
503	219	AnOr 7 219	572	172	AnOr 7 172
505	194	AnOr 7 194	573	272	AnOr 7 272
508	301	AnOr 7 301	574	369	AnOr 7 369
509	316	AnOr 7 316	576	380.3	AnOr 7 380.3
511	323	AnOr 7 323	577	294	AnOr 7 294
512	168	AnOr 7 168	578	258	AnOr 7 258
513	38	AnOr 7 38	579	266	AnOr 7 266
514	222	AnOr 7 222	580	405	-----
515	402	-----	581	170	AnOr 7 170
516	202	AnOr 7 202	582	317	AnOr 7 317
517	280	AnOr 7 280	584	370	AnOr 7 370
518	192	AnOr 7 192	585	406	-----
519	263	AnOr 7 263	586+587	407	-----
520	366	AnOr 7 366	588	281	AnOr 7 281
521	297	AnOr 7 297	592	348	AnOr 7 348
522	322	AnOr 7 322	593	232	AnOr 7 232
524	92	AnOr 7 92	594	319	AnOr 7 319
525+611b	403	-----	596	290	AnOr 7 290
527	165	AnOr 7 165	600	237	AnOr 7 237
528	380.1	AnOr 7 380.1	601	408	-----
529	199	AnOr 7 199	602b	409	-----
530	12	AnOr 7 12	603	410	-----
531	380.2	AnOr 7 380.2	604	411	-----
532	404	-----	605b	412	-----
533	171	AnOr 7 171	606	413	-----
534	314	AnOr 7 314	607	414	-----
535	308	AnOr 7 308	608(+)831	415	-----
536	191	AnOr 7 191	610	416	-----
537	248	AnOr 7 248	611	417	Civil JCS 32 (1980) 169
539	378	AnOr 7 378	612	418	-----
540	163	AnOr 7 163	613	419	-----
541	24	AnOr 7 24	614	420	-----
543	164	AnOr 7 164	615	421	-----
544	210	AnOr 7 210	616	422	-----
545	54	AnOr 7 54	617	423	-----
546	379	AnOr 7 379	618	424	-----
547	203	AnOr 7 203	619	425	-----
548	223	AnOr 7 223	620	426	-----
549	193	AnOr 7 193	621	427	-----
550	231	AnOr 7 231	622	428	-----

MM	N° Texto	Bibliografía	MM	N° Texto	Bibliografía
623	429	-----	682	486	-----
624	430	-----	683	487	-----
625	431	-----	684	488	-----
626	432	-----	685	489	-----
627	433	-----	686	490	-----
628	434	-----	687	491	-----
629+948	435	-----	688	492	-----
630+653	436	-----	689	493	-----
631	437	-----	690	494	-----
632	438	-----	691	495	-----
633	439	-----	692	496	-----
634	440	-----	693	497	-----
635	441	-----	694	498	-----
636	442	-----	695	499	-----
637	443	-----	696	500	-----
638	444	-----	697b	501	-----
639	445	-----	698	502	-----
640	446	-----	699	503	-----
641	447	-----	700	504	-----
642	448	-----	701	505	-----
643	449	-----	702	506	-----
644	450	-----	703	507	-----
645	451	-----	704	508	-----
646	452	-----	705	509	-----
647	453	-----	706	510	-----
648	454	-----	707	511	-----
649	455	-----	708	512	-----
650	456	-----	709	513	-----
651	457	-----	710a	514	-----
652	458	-----	710b	515	-----
654	459	-----	711a	516	-----
655	460	-----	711b	517	-----
656	461	-----	712+731b	518	-----
657	462	-----	713	519	-----
659	463	-----	714	520	-----
660	464	-----	715	521	-----
661	465	-----	716+910	522	-----
662	466	-----	718	523	-----
663	467	-----	719	524	-----
664+1138	468	-----	720	525	-----
665	469	-----	721	526	-----
666	470	-----	722	527	-----
667	471	-----	723	528	-----
668	472	-----	724	529	-----
669	473	-----	725	530	-----
670	474	-----	730	531	-----
671	475	-----	733	532	-----
672	476	-----	734	533	-----
673	477	-----	735	534	-----
674	478	-----	736	535	-----
675	479	-----	737	536	-----
676	480	-----	738	537	-----
677	481	-----	739+1071	538	-----
678	482	-----	740	539	-----
679	483	-----	741	540	-----
680	484	-----	742	541	-----
681	485	-----	743	542	-----

MM	N° Texto	Bibliografia
744	543	-----
745	544	-----
746	545	-----
747	546	-----
748	547	-----
749	548	-----
750	549	-----
751	550	-----
752	551	-----
753	552	-----
754	553	-----
755	554	-----
756	555	-----
757	556	-----
758	557	-----
759	558	-----
760	559	-----
761	560	-----
762	561	-----
763	562	-----
764	563	-----
765	564	-----
766	565	-----
767	566	-----
768	567	-----
769	568	-----
770	569	-----
771	570	-----
772	571	-----
773	572	-----
774	573	-----
775	574	-----
776	575	-----
777	576	-----
778	577	-----
779+788	578	-----
780	579	-----
781	580	-----
782	581	-----
783	582	-----
784	583	-----
785	584	-----
786	585	-----
787	586	-----
789	587	-----
790	588	-----
791	589	-----
792	590	-----
793	591	-----
794	592	-----
795	593	-----
796	594	-----
797	595	-----
799	596	-----
800	597	-----
802	598	-----
803	599	-----

MM	N° Texto	Bibliografia
805	600	-----
806	601	-----
807	602	-----
827	603	-----
834	604	-----
836+953	605	-----
(+)957		
838	606	-----
844	607	-----
848	608	-----
851	609	-----
852	610	-----
853	611	-----
858a	612	-----
867	613	-----
869+1131	614	-----
888	615	-----
891	616	-----
895b	617	-----
906	618	-----
907	619	-----
908	620	-----
909	621	-----
911	622	-----
912	623	-----
913	624	-----
915	625	-----
917	626	-----
918	627	-----
920	628	-----
921	629	-----
922	630	-----
923	631	-----
924	632	-----
926	633	-----
927	634	-----
928(+)943	635	-----
930	636	-----
931	637	-----
932	638	-----
934	639	-----
935	640	-----
938	641	-----
939	642	-----
940	643	-----
941	644	-----
942	645	-----
944	646	-----
945	647	-----
946	648	-----
947	649	-----
949	650	-----
951	651	-----
954	652	-----
955	653	-----
956	654	-----
958	655	-----

MM	N° Texto	Bibliografía
959	656	-----
960	657	-----
961	658	-----
962	659	-----
963	660	-----
964	661	-----
965	662	-----
966	663	-----
967	664	-----
968	665	-----
969	666	-----
970	667	-----
991	668	-----
992	669	-----
993	670	-----
994	671	-----
995	672	-----
996	673	-----
997	674	-----
998	675	-----
999	676	-----
1000	677	-----
1001	678	-----
1002	679	-----
1004	680	-----
1005	681	-----
1006	682	-----
1008	683	-----
1009	684	-----
1010	685	-----
1011	686	-----
1050	687	-----
1052	688	-----
1053	689	-----
1054	690	-----
1056	691	-----
1057	692	-----
1058	693	-----
1060	694	-----
1061	695	-----
1062	696	-----
1064	697	-----
1065	698	-----
1066	699	-----
1067	700	-----
1068	701	-----
1070	702	-----
1074	703	-----
1081	704	-----
1083	705	-----
1084	706	-----
1085	707	-----
1086	708	-----
1087	709	-----
1092	710	-----
1093	711	-----
1097	712	-----

MM	N° Texto	Bibliografía
1099	713	-----
1100	714	-----
1103	715	-----
1104	716	-----
1105	717	-----
1106	718	-----
1107	719	-----
1108	720	-----
1109	721	-----
1110	722	-----
1111	723	-----
1112	724	-----
1113	725	-----
1116	726	-----
1117	727	-----
1118	728	-----
1119	729	-----
1120	730	-----
1121	731	-----
1122	732	-----
1123	733	-----
1124	734	-----
1125	735	-----
1126	736	-----
1128	737	-----
1129	738	-----
1130	739	-----
1136	740	-----
1137	741	-----
1139	742	-----
1141	743	-----
1142	744	-----
1143	745	-----
1144	746	-----
1146	747	-----
1149	748	-----
1151	749	-----
1152	750	-----
1155	751	-----
1156	752	-----
1157	753	-----
1158	754	-----
1159	755	-----
1160	756	-----
1161	757	-----
1162	758	-----
1163	759	-----
1164	760	-----
1165	761	-----
1166	762	-----
1167	763	-----
1168	764	-----
1169	765	-----



TABLILLAS PREVIAMENTE EDITADAS

Bibliografía	N° Texto	MM	Bibliografía	N° Texto	MM
Deimel OrSP 2 (1920) 55	303	174	AnOr 7 51	51	157
Deimel OrSP 2 (1920) 56	264	171	AnOr 7 52	52	24
AnOr 7 1	1	23	AnOr 7 53	53	25
AnOr 7 2	2	33	AnOr 7 54	54	545
AnOr 7 3	3	44	AnOr 7 55	55	29
AnOr 7 4	4	107	AnOr 7 56	56	28
AnOr 7 5	5	167	AnOr 7 57	57	31
AnOr 7 6	6	64	AnOr 7 58	58	30
AnOr 7 7	7	58	AnOr 7 59	59	34
AnOr 7 8	8	62	AnOr 7 60	60	32
AnOr 7 9	9	77	AnOr 7 61	61	37
AnOr 7 10	10	76	AnOr 7 62	62	38
AnOr 7 11	11	75	AnOr 7 63	63	43
AnOr 7 12	12	530	AnOr 7 64	64	191
AnOr 7 13	13	74	AnOr 7 65	65	46
AnOr 7 14	14	90	AnOr 7 66	66	42
AnOr 7 15	15	89	AnOr 7 67	67	45
AnOr 7 16	16	84	AnOr 7 68	68	47
AnOr 7 17	17	97	AnOr 7 69	69	48
AnOr 7 18	18	98	AnOr 7 70	70	55
AnOr 7 19	19	99	AnOr 7 71	71	56
AnOr 7 20	20	219	AnOr 7 72	72	67
AnOr 7 21	21	220	AnOr 7 73	73	71
AnOr 7 22	22	101	AnOr 7 74	74	65
AnOr 7 23	23	105	AnOr 7 75	75	82
AnOr 7 24	24	541	AnOr 7 76	76	79
AnOr 7 25	25	114	AnOr 7 77	77	81
AnOr 7 26	26	111	AnOr 7 78	78	72
AnOr 7 27	27	187	AnOr 7 79	79	201
AnOr 7 28	28	125	AnOr 7 80	80	78
AnOr 7 29	29	213	AnOr 7 81	81	432
AnOr 7 30	30	121	AnOr 7 82	82	95
AnOr 7 31	31	119	AnOr 7 83	83	92
AnOr 7 32	32	127	AnOr 7 84	84	83
AnOr 7 33	33	123	AnOr 7 85	85	85
AnOr 7 34	34	133	AnOr 7 86	86	91
AnOr 7 35	35	132	AnOr 7 87	87	87
AnOr 7 36	36	135	AnOr 7 88	88	52
AnOr 7 37	37	75b	AnOr 7 89	89	36
AnOr 7 38	38	513	AnOr 7 90	90	181
AnOr 7 39	39	131	AnOr 7 91	91	51
AnOr 7 40	40	40	AnOr 7 92	92	524
AnOr 7 41	41	141	AnOr 7 93	93	221
AnOr 7 42	42	39	AnOr 7 94	94	96
AnOr 7 43	43	147	AnOr 7 95	95	268
AnOr 7 44	44	146	AnOr 7 96	96	215
AnOr 7 45	45	50	AnOr 7 97	97	552
AnOr 7 46	46	149	AnOr 7 98	98	562
AnOr 7 47	47	156	AnOr 7 99	99	103
AnOr 7 48	48	162	AnOr 7 100	100	145
AnOr 7 49	49	160	AnOr 7 101	101	117
AnOr 7 50	50	70	AnOr 7 102	102	124

Bibliografía	N° Texto	MM	Bibliografía	N° Texto	MM
<i>AnOr 7 103</i>	103	120	<i>AnOr 7 159</i>	159	148
<i>AnOr 7 104</i>	104	143	<i>AnOr 7 160</i>	160	159
<i>AnOr 7 105</i>	105	500	<i>AnOr 7 161</i>	161	192
<i>AnOr 7 106</i>	106	155	<i>AnOr 7 162</i>	162	422
<i>AnOr 7 107</i>	107	152	<i>AnOr 7 163</i>	163	540
<i>AnOr 7 108</i>	108	154	<i>AnOr 7 164</i>	164	543
<i>AnOr 7 109</i>	109	153	<i>AnOr 7 165</i>	165	527
<i>AnOr 7 110</i>	110	202	<i>AnOr 7 166</i>	166	115
<i>AnOr 7 111</i>	111	203	<i>AnOr 7 167</i>	167	49
<i>AnOr 7 112</i>	112	151	<i>AnOr 7 168</i>	168	51
<i>AnOr 7 113</i>	113	217	<i>AnOr 7 169</i>	169	358
<i>AnOr 7 114</i>	114	26	<i>AnOr 7 170</i>	170	581
<i>AnOr 7 115</i>	115	35	<i>AnOr 7 171</i>	171	533
<i>AnOr 7 116</i>	116	446	<i>AnOr 7 172</i>	172	572
<i>AnOr 7 117</i>	117	460	<i>AnOr 7 173</i>	173	456
<i>AnOr 7 118</i>	118	455	<i>AnOr 7 174</i>	174	172
<i>AnOr 7 119</i>	119	451	<i>AnOr 7 175</i>	175	339
<i>AnOr 7 120</i>	120	218	<i>AnOr 7 176</i>	176	556
<i>AnOr 7 121</i>	121	457	<i>AnOr 7 177</i>	177	376
<i>AnOr 7 122</i>	122	94	<i>AnOr 7 178</i>	178	437
<i>AnOr 7 123</i>	123	458	<i>AnOr 7 179</i>	179	206
<i>AnOr 7 124</i>	124	564	<i>AnOr 7 180</i>	180	139
<i>AnOr 7 125</i>	125	206b	<i>AnOr 7 181</i>	181	340
<i>AnOr 7 126</i>	126	436	<i>AnOr 7 182</i>	182	178
<i>AnOr 7 127</i>	127	109	<i>AnOr 7 183</i>	183	392
<i>AnOr 7 128</i>	128	102	<i>AnOr 7 184</i>	184	412
<i>AnOr 7 129</i>	129	165	<i>AnOr 7 185</i>	185	346
<i>AnOr 7 130</i>	130	108	<i>AnOr 7 186</i>	186	390
<i>AnOr 7 131</i>	131	212	<i>AnOr 7 187</i>	187	381
<i>AnOr 7 132</i>	132	110	<i>AnOr 7 188</i>	188	408
<i>AnOr 7 133</i>	133	214	<i>AnOr 7 189</i>	189	419
<i>AnOr 7 134</i>	134	459	<i>AnOr 7 190</i>	190	385
<i>AnOr 7 135</i>	135	113	<i>AnOr 7 191</i>	191	536
<i>AnOr 7 136</i>	136	211	<i>AnOr 7 192</i>	192	518
<i>AnOr 7 137</i>	137	445	<i>AnOr 7 193</i>	193	549
<i>AnOr 7 138</i>	138	452	<i>AnOr 7 194</i>	194	505
<i>AnOr 7 139</i>	139	448	<i>AnOr 7 195</i>	195	559
<i>AnOr 7 140</i>	140	177	<i>AnOr 7 196</i>	196	223
<i>AnOr 7 141</i>	141	163	<i>AnOr 7 197</i>	197	343
<i>AnOr 7 142</i>	142	216	<i>AnOr 7 198</i>	198	365
<i>AnOr 7 143</i>	143	444	<i>AnOr 7 199</i>	199	529
<i>AnOr 7 144 (= MM 54)</i>	144	54+1101	<i>AnOr 7 200</i>	200	570
<i>AnOr 7 145</i>	145	88	<i>AnOr 7 201</i>	201	443
<i>AnOr 7 146</i>	146	555	<i>AnOr 7 202</i>	202	516
<i>AnOr 7 147</i>	147	27	<i>AnOr 7 203</i>	203	547
<i>AnOr 7 148</i>	148	59	<i>AnOr 7 204</i>	204	447
<i>AnOr 7 149</i>	149	57	<i>AnOr 7 205</i>	205	359
<i>AnOr 7 150</i>	150	93	<i>AnOr 7 206</i>	206	409
<i>AnOr 7 151</i>	151	73	<i>AnOr 7 207</i>	207	104
<i>AnOr 7 152</i>	152	86	<i>AnOr 7 208</i>	208	207
<i>AnOr 7 153</i>	153	41	<i>AnOr 7 209</i>	209	551
<i>AnOr 7 154</i>	154	491	<i>AnOr 7 210</i>	210	544
<i>AnOr 7 155</i>	155	69	<i>AnOr 7 211</i>	211	176
<i>AnOr 7 156</i>	156	193	<i>AnOr 7 212</i>	212	398
<i>AnOr 7 157</i>	157	205	<i>AnOr 7 213</i>	213	112
<i>AnOr 7 158</i>	158	60	<i>AnOr 7 214</i>	214	168

Bibliografia	N° Texto	MM	Bibliografia	N° Texto	MM
<i>AnOr</i> 7 215	215	169	<i>AnOr</i> 7 271	271	420
<i>AnOr</i> 7 216	216	391	<i>AnOr</i> 7 272	272	573
<i>AnOr</i> 7 217	217	403	<i>AnOr</i> 7 273	273	116
<i>AnOr</i> 7 218	218	379	<i>AnOr</i> 7 274	274	461
<i>AnOr</i> 7 219	219	503	<i>AnOr</i> 7 275	275	384
<i>AnOr</i> 7 220	220	229	<i>AnOr</i> 7 276	276	424
<i>AnOr</i> 7 221	221	380	<i>AnOr</i> 7 277	277	336
<i>AnOr</i> 7 222	222	514	<i>AnOr</i> 7 278	278	345
<i>AnOr</i> 7 223	223	548	<i>AnOr</i> 7 279	279	569
<i>AnOr</i> 7 224	224	450	<i>AnOr</i> 7 280	280	517
<i>AnOr</i> 7 225	225	411	<i>AnOr</i> 7 281	281	588
<i>AnOr</i> 7 226	226	144	<i>AnOr</i> 7 282	282	68
<i>AnOr</i> 7 227	227	434	<i>AnOr</i> 7 283	283	179
<i>AnOr</i> 7 228	228	126	<i>AnOr</i> 7 284	284	184
<i>AnOr</i> 7 229	229	129	<i>AnOr</i> 7 285	285	188
<i>AnOr</i> 7 230	230	349	<i>AnOr</i> 7 286	286	225
<i>AnOr</i> 7 231	231	550	<i>AnOr</i> 7 287	287	377
<i>AnOr</i> 7 232	232	593	<i>AnOr</i> 7 288	288	428
<i>AnOr</i> 7 233	233	368	<i>AnOr</i> 7 289	289	493
<i>AnOr</i> 7 234	234	421	<i>AnOr</i> 7 290	290	596
<i>AnOr</i> 7 235	235	498	<i>AnOr</i> 7 291	291	387
<i>AnOr</i> 7 236	236	232	<i>AnOr</i> 7 292	292	414
<i>AnOr</i> 7 237	237	600	<i>AnOr</i> 7 293	293	567
<i>AnOr</i> 7 238	238	136	<i>AnOr</i> 7 294	294	577
<i>AnOr</i> 7 239	239	138	<i>AnOr</i> 7 295	295	186
<i>AnOr</i> 7 240	240	494	<i>AnOr</i> 7 296	296	190
<i>AnOr</i> 7 241	241	394	<i>AnOr</i> 7 297	297	521
<i>AnOr</i> 7 242	242	140	<i>AnOr</i> 7 298	298	375
<i>AnOr</i> 7 243	243	402	<i>AnOr</i> 7 299	299	565
<i>AnOr</i> 7 244	244	410	<i>AnOr</i> 7 300	300	563
<i>AnOr</i> 7 245	245	407	<i>AnOr</i> 7 301	301	508
<i>AnOr</i> 7 246	246	158	<i>AnOr</i> 7 302	302	496
<i>AnOr</i> 7 247 (= MM 166)	247	166+182	<i>AnOr</i> 7 303	303	174
<i>AnOr</i> 7 248	248	537	<i>AnOr</i> 7 304	304	341
<i>AnOr</i> 7 249	249	228	<i>AnOr</i> 7 305	305	425
<i>AnOr</i> 7 250	250	338	<i>AnOr</i> 7 306	306	454
<i>AnOr</i> 7 251	251	355	<i>AnOr</i> 7 307	307	405
<i>AnOr</i> 7 252	252	389	<i>AnOr</i> 7 308	308	535
<i>AnOr</i> 7 253	253	397	<i>AnOr</i> 7 309	309	388
<i>AnOr</i> 7 254	254	406	<i>AnOr</i> 7 310	310	383
<i>AnOr</i> 7 255	255	435	<i>AnOr</i> 7 311	311	198
<i>AnOr</i> 7 256	256	161	<i>AnOr</i> 7 312	312	61
<i>AnOr</i> 7 257	257	356	<i>AnOr</i> 7 313	313	197
<i>AnOr</i> 7 258	258	578	<i>AnOr</i> 7 314	314	534
<i>AnOr</i> 7 259	259	499	<i>AnOr</i> 7 315	315	185
<i>AnOr</i> 7 260	260	373	<i>AnOr</i> 7 316	316	509
<i>AnOr</i> 7 261	261	453	<i>AnOr</i> 7 317	317	582
<i>AnOr</i> 7 262	262	130	<i>AnOr</i> 7 318	318	400
<i>AnOr</i> 7 263	263	519	<i>AnOr</i> 7 319	319	594
<i>AnOr</i> 7 264	264	171	<i>AnOr</i> 7 320	320	417
<i>AnOr</i> 7 265	265	354	<i>AnOr</i> 7 321	321	495
<i>AnOr</i> 7 266	266	579	<i>AnOr</i> 7 322	322	522
<i>AnOr</i> 7 267	267	224	<i>AnOr</i> 7 323	323	511
<i>AnOr</i> 7 268	268	357	<i>AnOr</i> 7 324	324	553
<i>AnOr</i> 7 269	269	416	<i>AnOr</i> 7 325	325	393
<i>AnOr</i> 7 270	270	378	<i>AnOr</i> 7 326	326	344

Bibliografía	Nº Texto	MM	Bibliografía	Nº Texto	MM
<i>AnOr</i> 7 327	327	164	<i>AnOr</i> 7 358	358	366
<i>AnOr</i> 7 328	328	180	<i>AnOr</i> 7 359	359	369
<i>AnOr</i> 7 329	329	195	<i>AnOr</i> 7 360	360	371
<i>AnOr</i> 7 330	330	80	<i>AnOr</i> 7 361	361	382
<i>AnOr</i> 7 331	331	199	<i>AnOr</i> 7 362	362	334
<i>AnOr</i> 7 332 (= MM 204)	332	204+208	<i>AnOr</i> 7 363	363	335
y 333 (= MM 208)			<i>AnOr</i> 7 364	364	342
<i>AnOr</i> 7 333 (v. nº 332)			<i>AnOr</i> 7 365	365	347
<i>AnOr</i> 7 334	334	386	<i>AnOr</i> 7 366	366	520
<i>AnOr</i> 7 335	335	395	<i>AnOr</i> 7 367	367	557
<i>AnOr</i> 7 336	336	396	<i>AnOr</i> 7 368 (= MM 568)	368	568+798
<i>AnOr</i> 7 337	337	399	<i>AnOr</i> 7 369	369	574
<i>AnOr</i> 7 338	338	142	<i>AnOr</i> 7 370	370	584
<i>AnOr</i> 7 339	339	183	<i>AnOr</i> 7 371	371	200
<i>AnOr</i> 7 340	340	372	<i>AnOr</i> 7 372 (sarg.)		497
<i>AnOr</i> 7 341	341	415	<i>AnOr</i> 7 373	373	122
<i>AnOr</i> 7 342	342	426	<i>AnOr</i> 7 374	374	196
<i>AnOr</i> 7 343 (= MM 427)	343	364+374	<i>AnOr</i> 7 375	375	189
y 357 (= MM 364)		+427+658	<i>AnOr</i> 7 376	376	53
		+843+933	<i>AnOr</i> 7 377	377	137
<i>AnOr</i> 7 344	344	430	<i>AnOr</i> 7 378	378	539
<i>AnOr</i> 7 345	345	429	<i>AnOr</i> 7 379	379	546
<i>AnOr</i> 7 346	346	433	<i>AnOr</i> 7 380.1	380.1	528
<i>AnOr</i> 7 347	347	438	<i>AnOr</i> 7 380.2	380.2	531
<i>AnOr</i> 7 348	348	592	<i>AnOr</i> 7 380.3	380.3	576
<i>AnOr</i> 7 349	349	561	<i>AnOr</i> 7 380.4	380.4	209
<i>AnOr</i> 7 350	350	449	<i>AnOr</i> 7 380.5	380.5	363
<i>AnOr</i> 7 351	351	350	<i>AnOr</i> 7 380.6	380.6	337
<i>AnOr</i> 7 352	352	333	<i>AnOr</i> 7 380.7	380.7	222
<i>AnOr</i> 7 353	353	370	<i>AnOr</i> 7 380.8	380.8	226
<i>AnOr</i> 7 354	354	351	<i>AnOr</i> 7 380.9	380.9	360
<i>AnOr</i> 7 355	355	352	<i>AnOr</i> 7 380.10	380.10	348
<i>AnOr</i> 7 356	356	361	<i>AnOr</i> 7 381	381	490
<i>AnOr</i> 7 357 (v. nº 343)			Civil JCS 32 (1980) 169	417	611

COPIAS



1 (MM 23)

AnOr 7 1
Drehem
Š30/vi/-

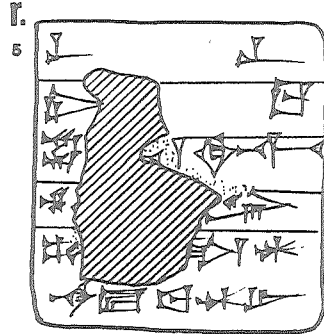
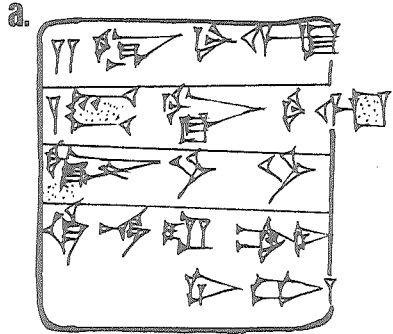

2 (MM 33)

AnOr 7 2
Drehem
Š36/ix/-

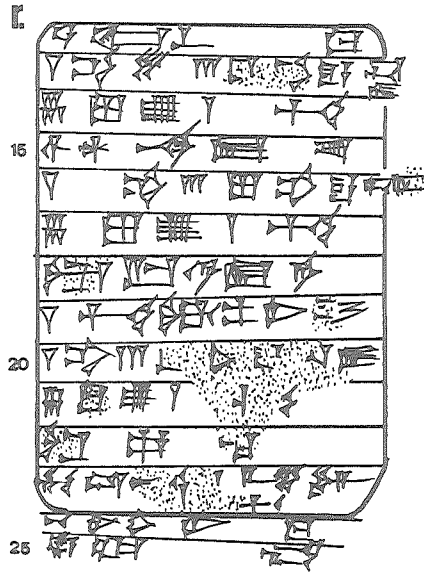
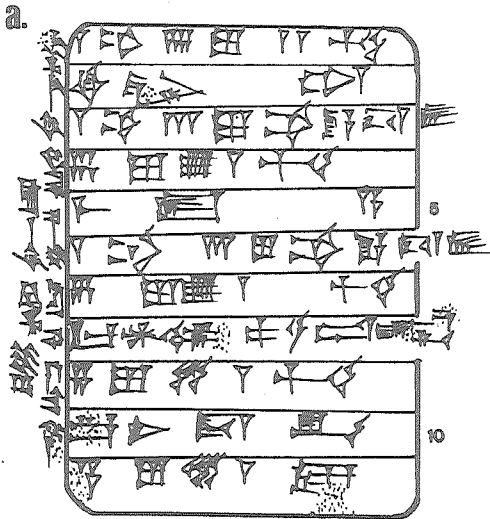

3 (MM 44)

AnOr 7 3
Drehem
Š39/v/-

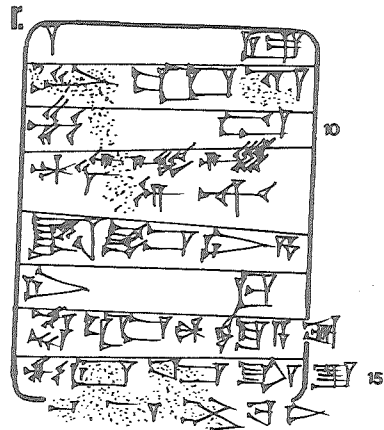
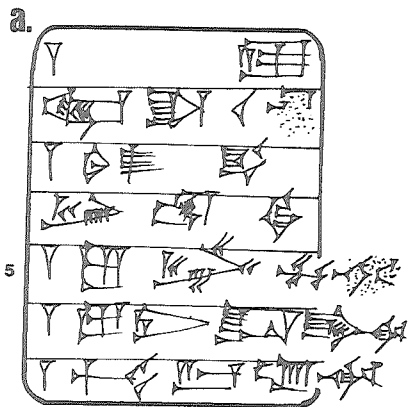

4 (MM 107)

AnOr 7 4
Drehem'
Š42 ó AS6/vii ó x/-

Envoltorio cerrado

4. Sello:

- i Šul-gi
nita kal-ga
lugal Uri₅/^{hi}-ma
lugal ^dUb-/da limmu₂-ba
- ii E₂-u₆-[e]
ša[br]ja (UGULA.[A]L)
arad₂-[zu]

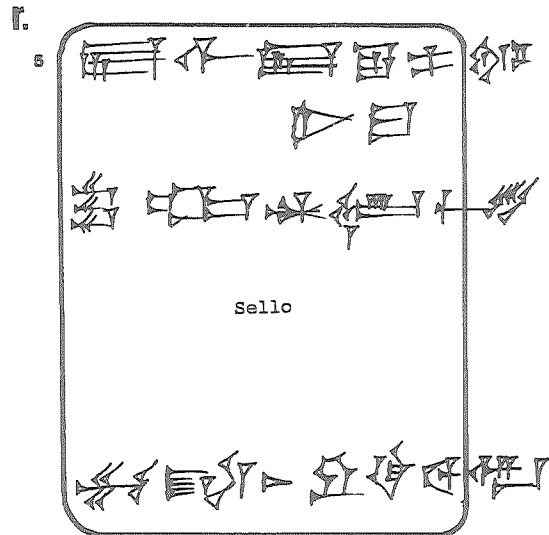
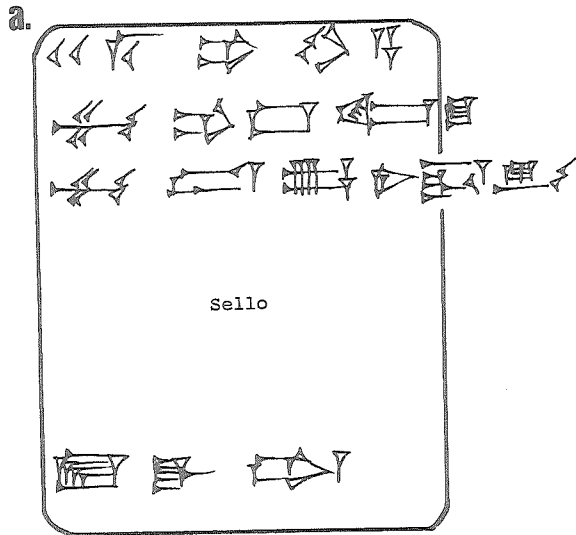

5 (MM 167)

AnOr 7 5
Drehem
IS2/x/-

5. Sello:

- Du₁₁-ga dub-sar
dumu Lu₂-^dNin-gir₂-su
sipa na-kab-tum

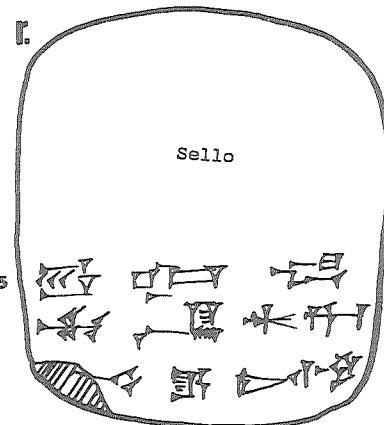
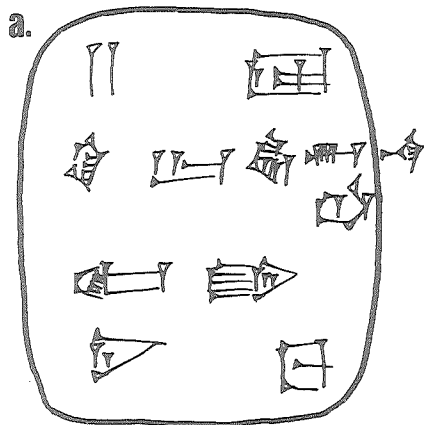

6 (MM 64)

AnOr 7 6
Drehem
Š44/ii/-

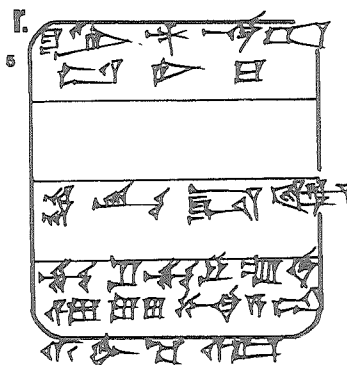
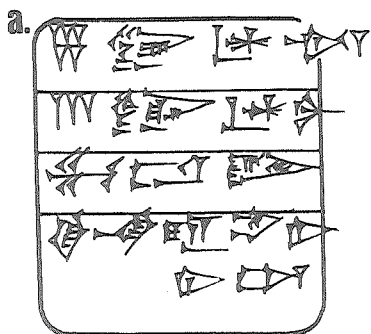

7 (MM 58)

AnOr 7 7
Drehem
Š44/ii/15

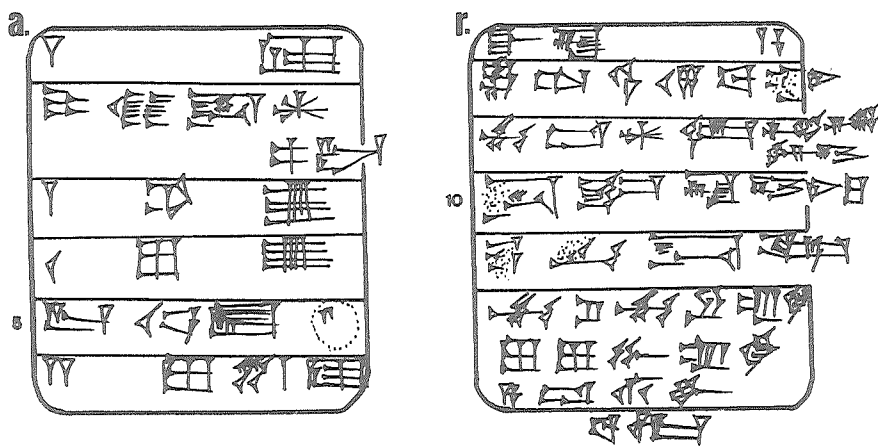

8 (MM 62)

AnOr 7 8
Drehem
Š44/vi/5,10

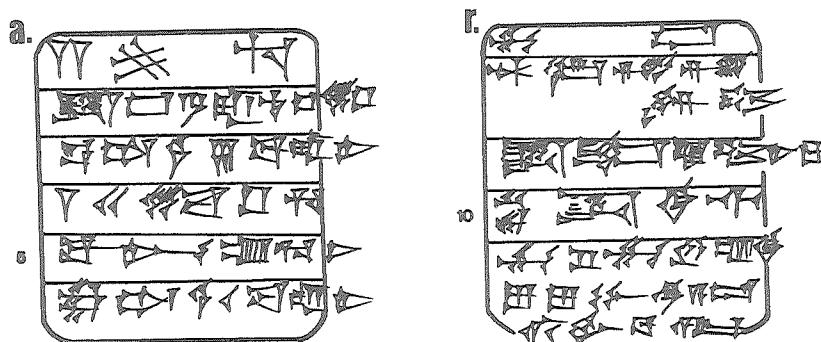

9 (MM 77)

AnOr 7 9
Drehem
Š46/x/-

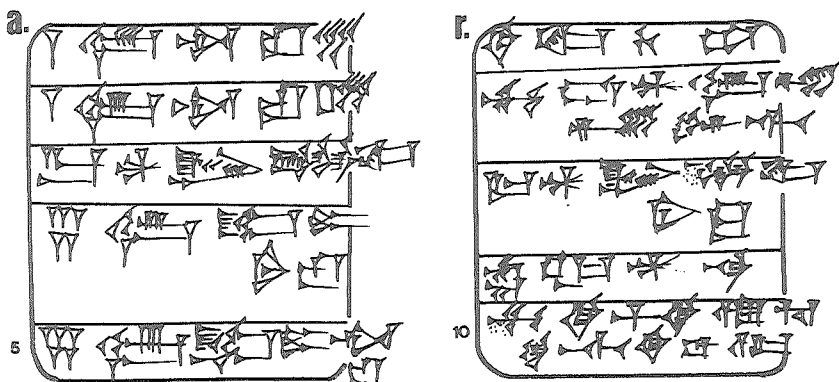

10 (MM 76)

AnOr 7 10
Drehem
Š46/x/13 6 23

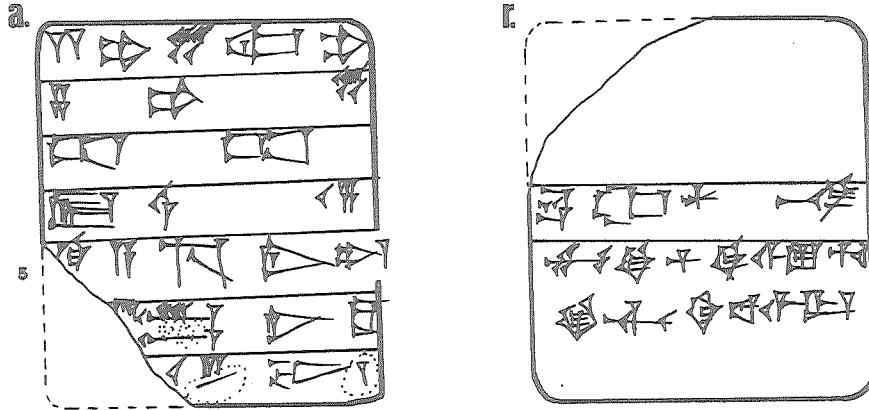

11 (MM 75)

AnOr 7 11
Drehem
Š46/xii/-

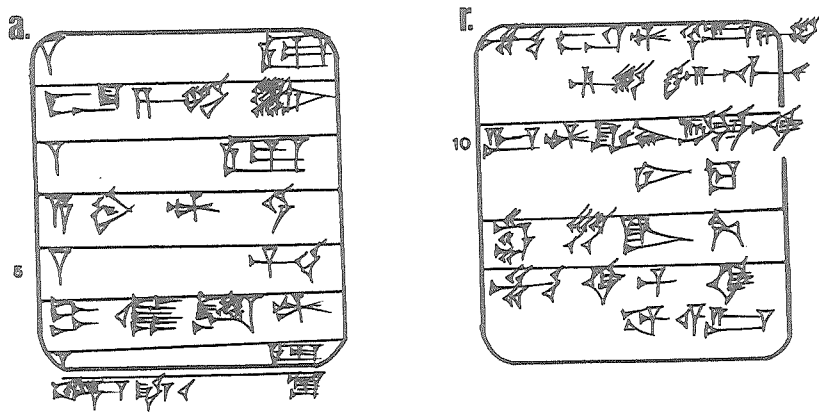

12 (MM 530)

AnOr 7 12
Drehem
Š46/xii/-

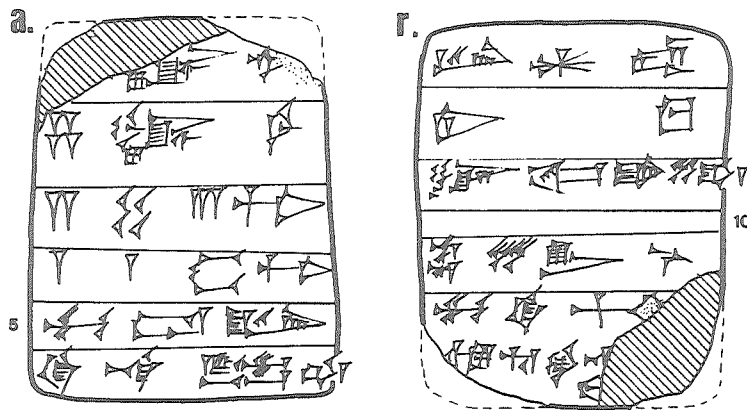

13 (MM 74)

AnOr 7 13
Drehem
Š46/xii/4-10

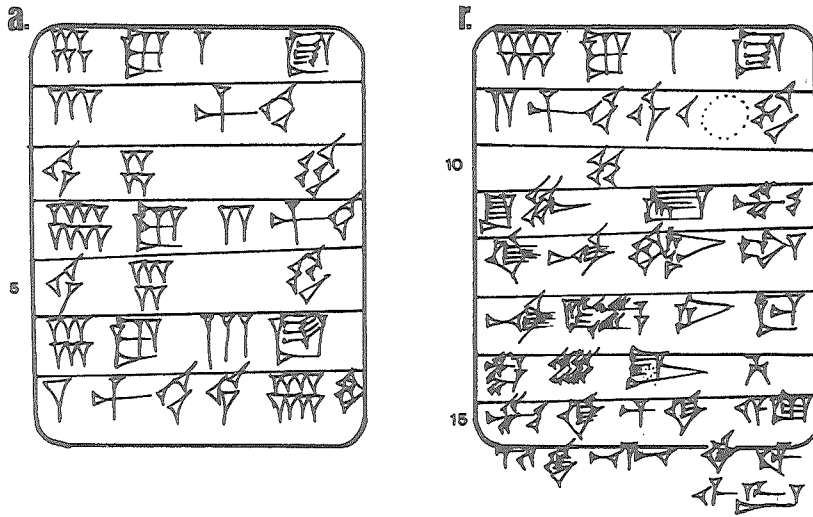

14 (MM 90)

AnOr 7 14
Drehem
Š47/v/-

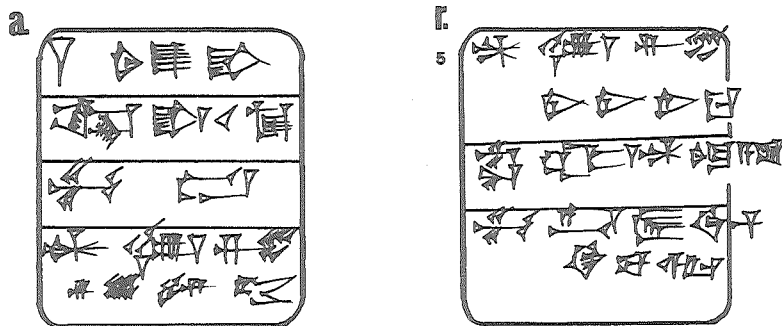

15 (MM 89)

AnOr 7 15
Drehem
Š47/ix/2

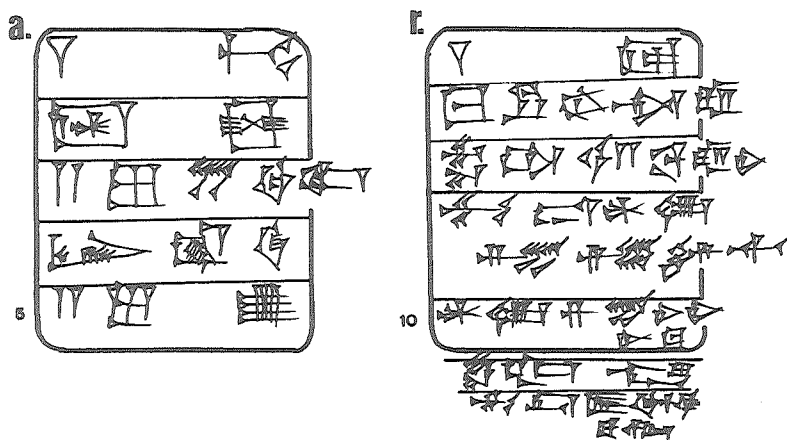

16 (MM 84)

AnOr 7 16
Drehem
Š47/i/-

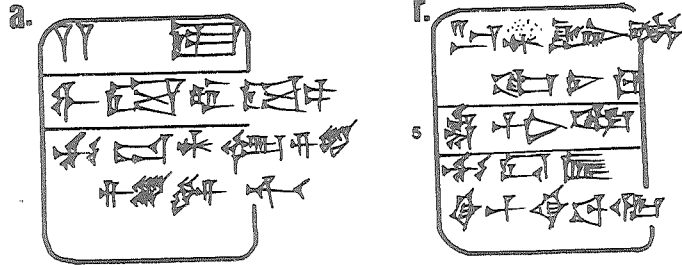

17 (MM 97)

AnOr 7 17
Drehem
Š48/xii/-



19 (MM 99)

AnOr 7 19
Drehem
AS1/vi/-

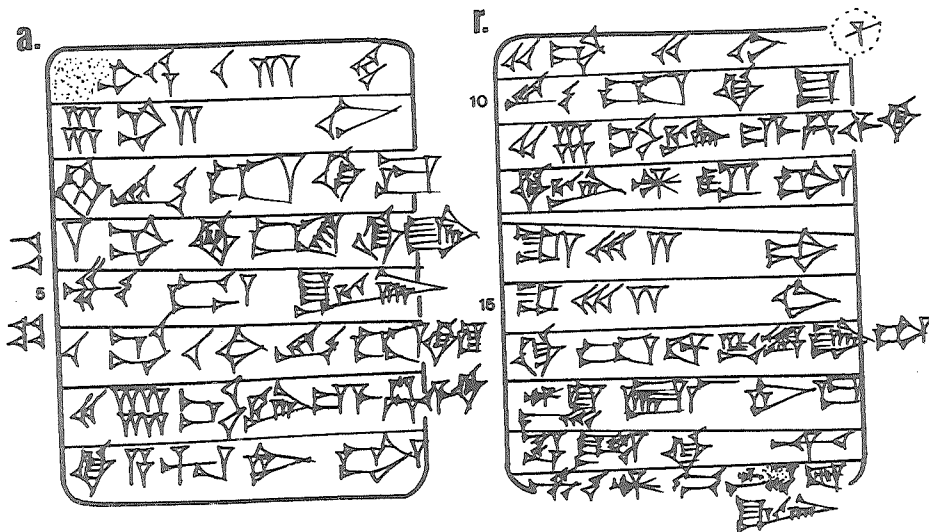

18 (MM 98)

AnOr 7 18
Umma
ASI/-/-

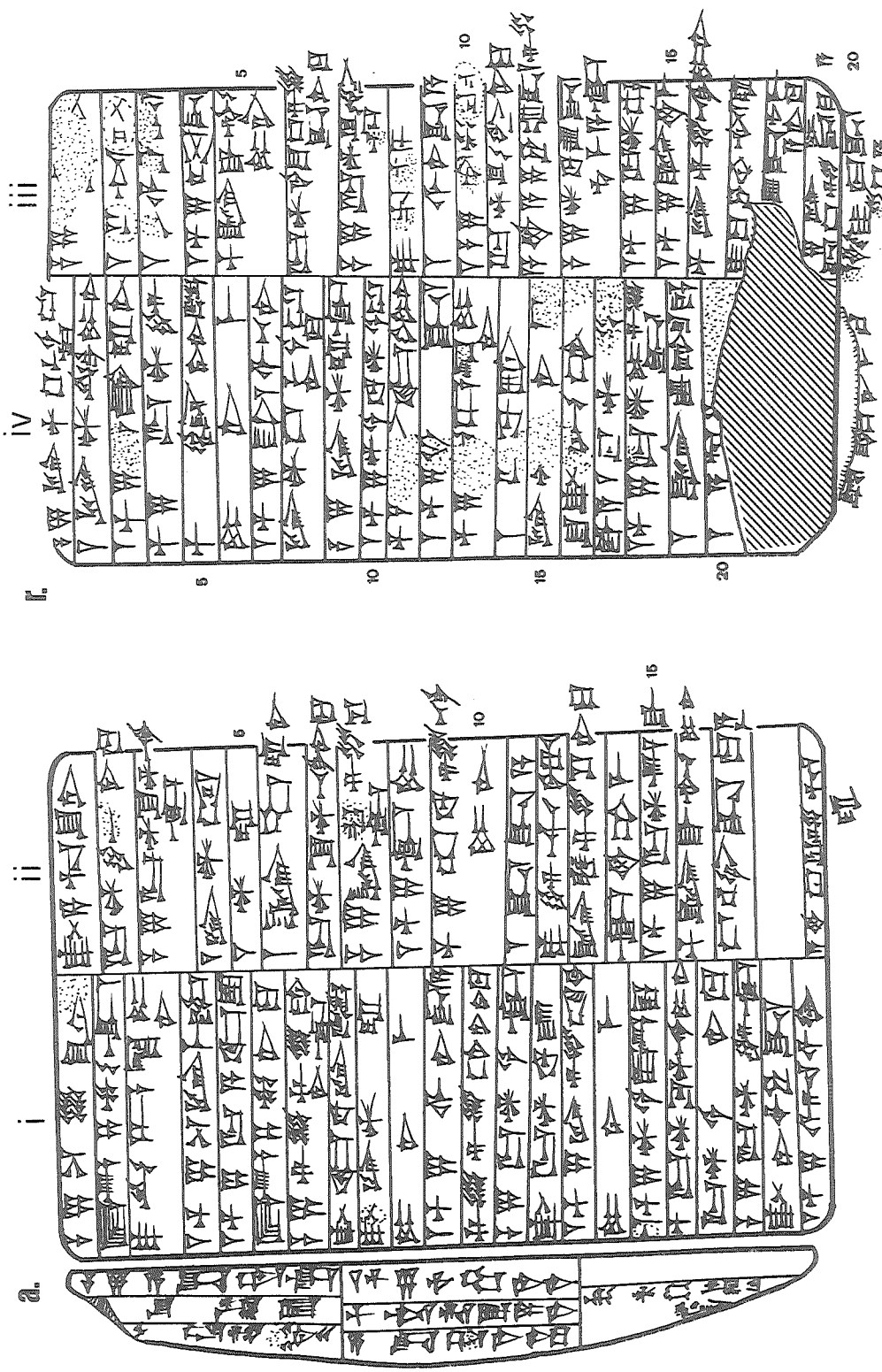

20 (MM 219)

AnOr 7 20
Drehem
AS1/x/29

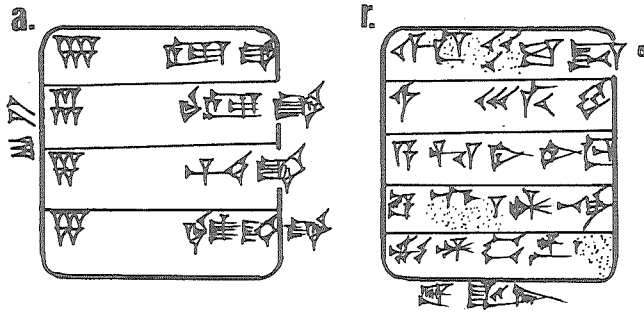

21 (MM 220)

AnOr 7 21
Drehem
AS3/viii/17

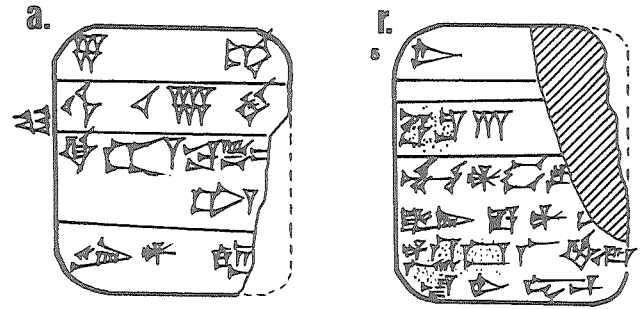

22 (MM 101)

AnOr 7 22
Drehem
AS3/vii/-

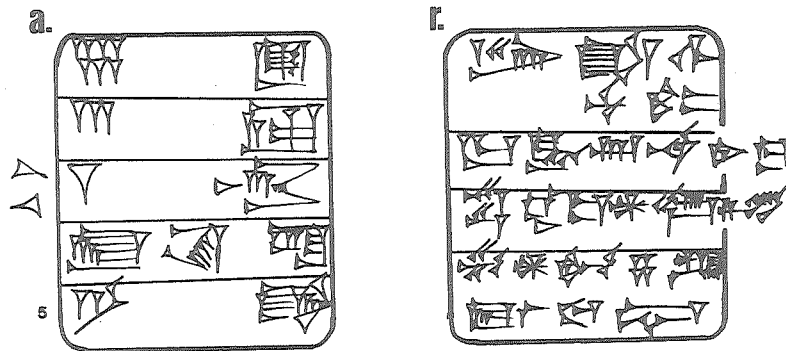

23 (MM 105)

AnOr 7 23
Drehem
AS5/-

23. Sello:

- i ⁴Šul-gi
nita kal-ga
lugal Uri₂/⁴-ma
- ii Na-[šā₂]
[kurušda]
arad₂-[zu]

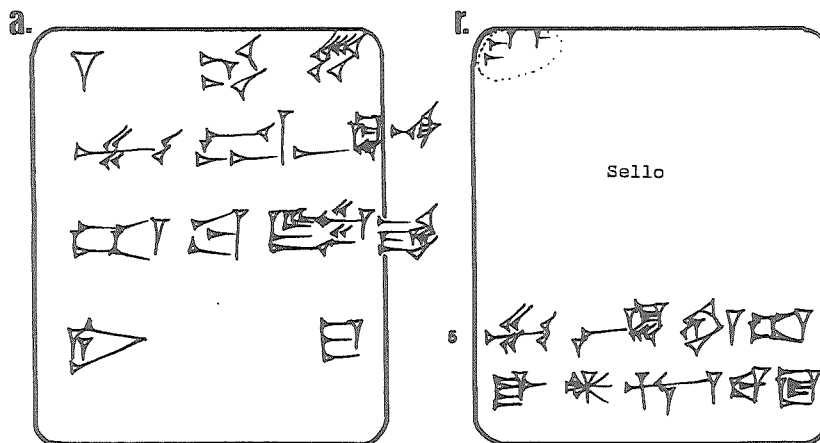

24 (MM 541)

AnOr 7 24
Drehem
AS5/iv/8

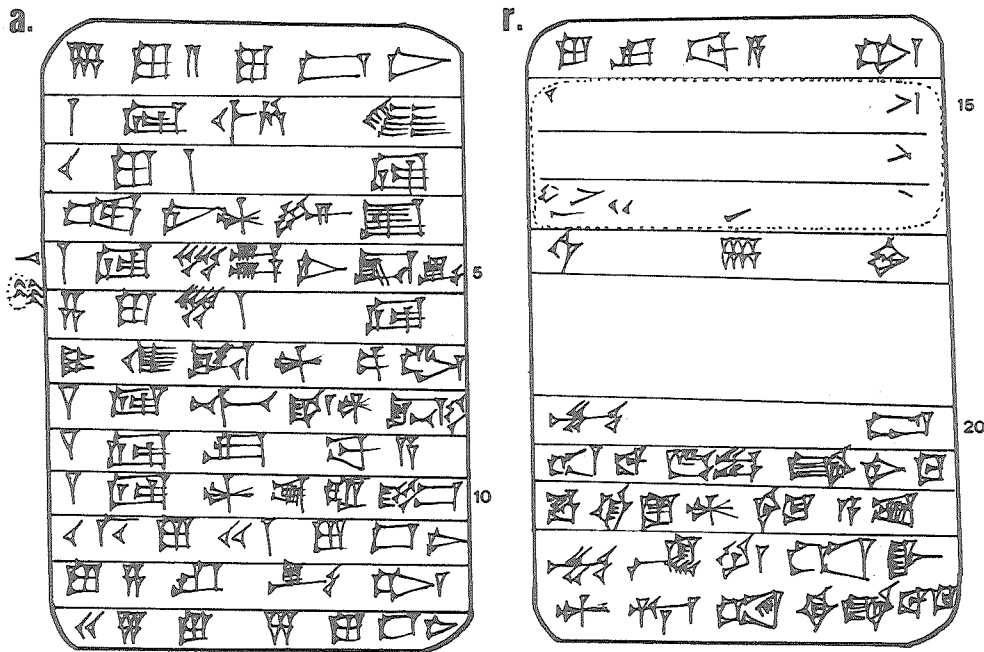

25 (MM 114)

AnOr 7 25
Drehem
AS8/ii/7

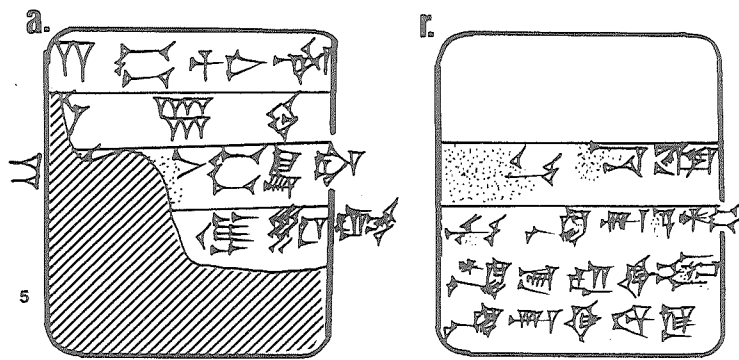

26 (MM 111)

AnOr 7 26
Drehem
AS8/x/-

26. Sello:

A-ha-ni-šu
sipa lugal

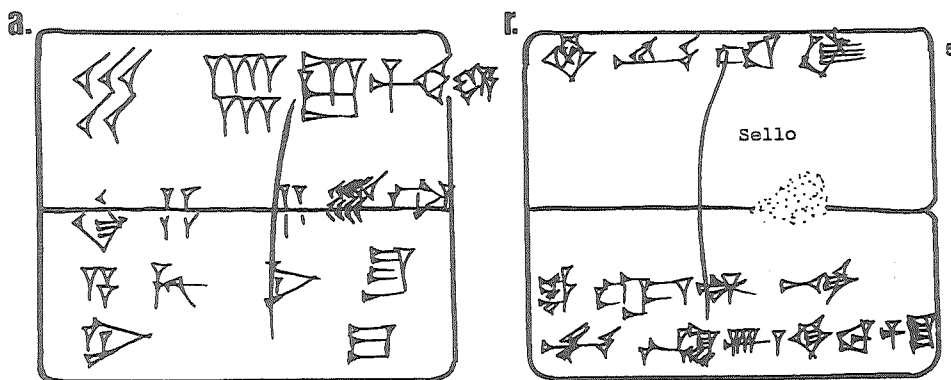

27 (MM 187)

AnOr 7 27
Drehem
[]vii/20

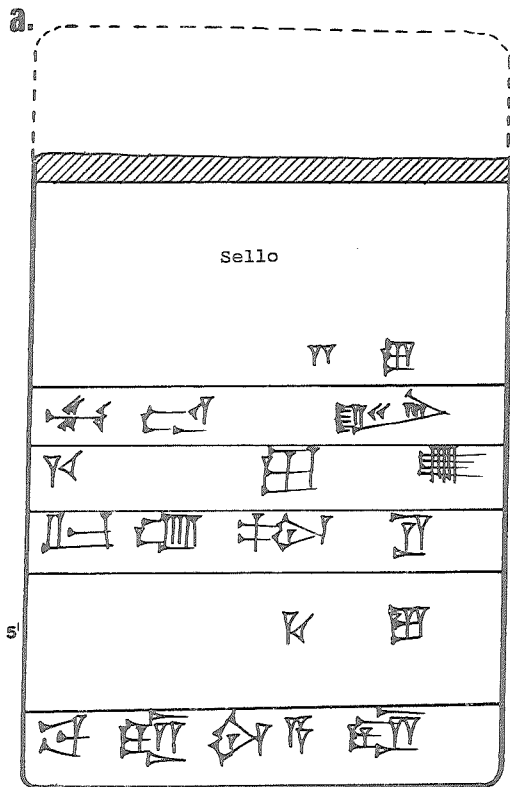

27. Sello:

- i ^dSu-^dSuen
lugal kal-ga /lugal Uri₃/^{ki}-ma
lugal ^dUb-/da limmu₂-ba
- ii Nu-ur₂-^dSuen
dub-sar
dumu I-ti-/Er₃-ra
arad₂-zu

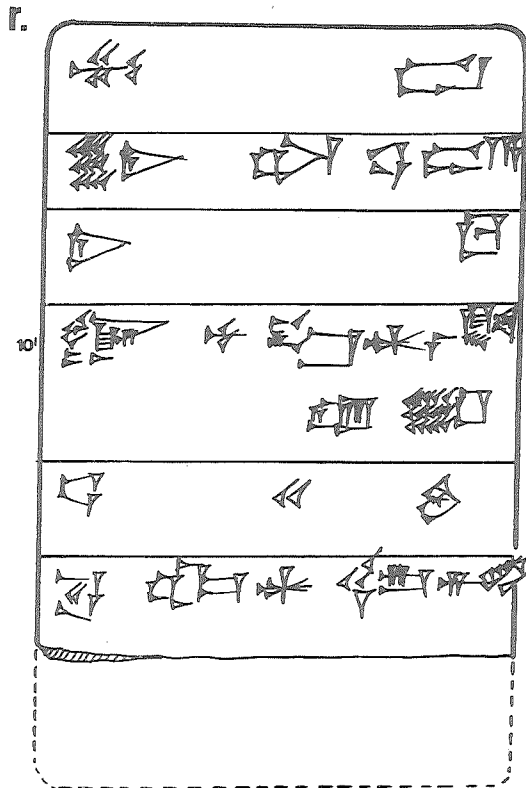

28 (MM 125)

AnOr 7 28
Drehem
ŠS2/iii/8

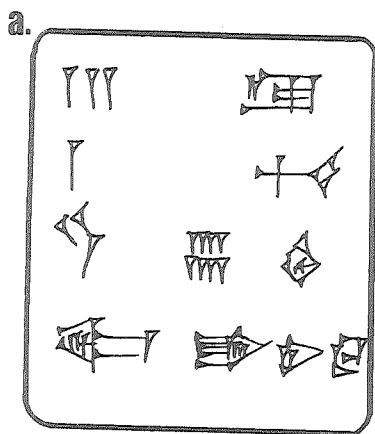

28. Sello:

Ur-mes
dumu La-na kurušda

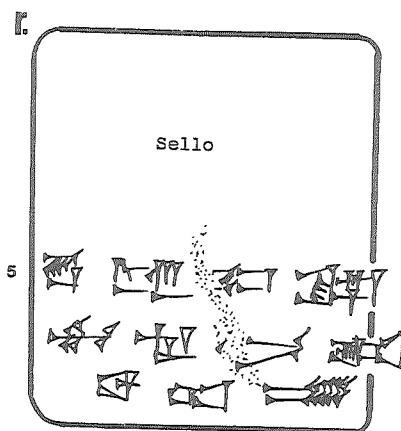

30 (MM 121)

AnOr 7 30
Drehem
ŠS2/v/-

30. Sello:

Du₁₁-ga dub-sar
dumu Lu₂-^dNin-gir₂-su
sipa na-kab-tum

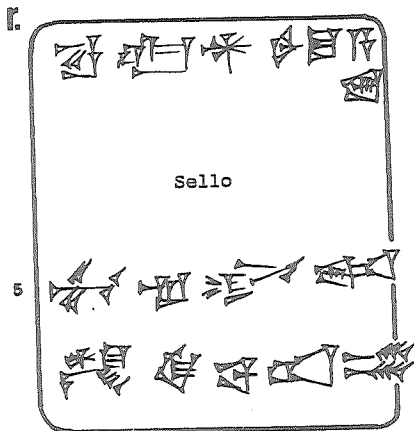
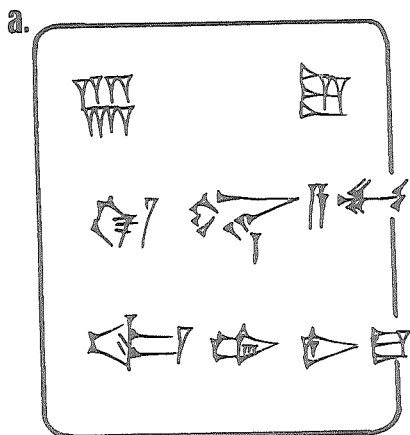

29 (MM 213)

AnOr 7 29
Drehem
AS3/iv/12

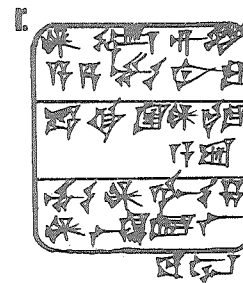
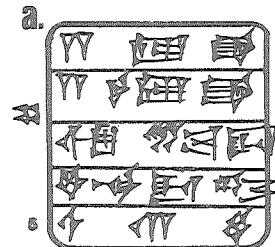

31 (MM 119)

AnOr 7 31
Drehem
ŠS2/vi/9,10

31. Sello:

Ur-mes
dumu La-na kurušda

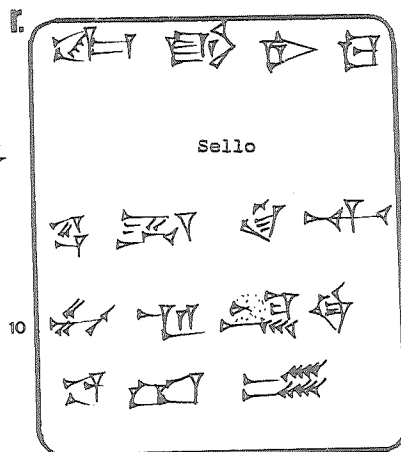
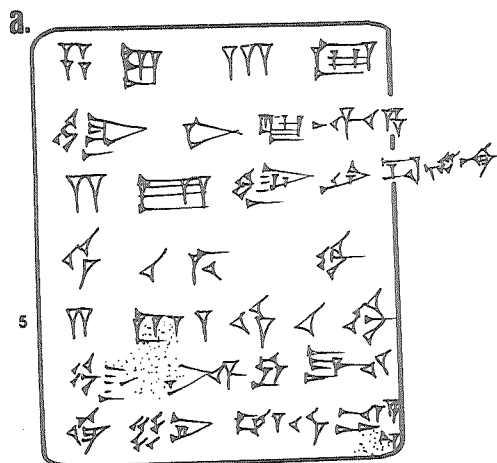

32 (MM 127)

AnOr 7 32
Drehem
ŠS2/ix/8~26

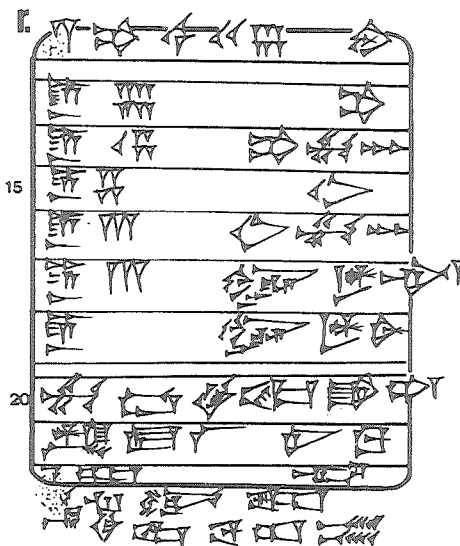
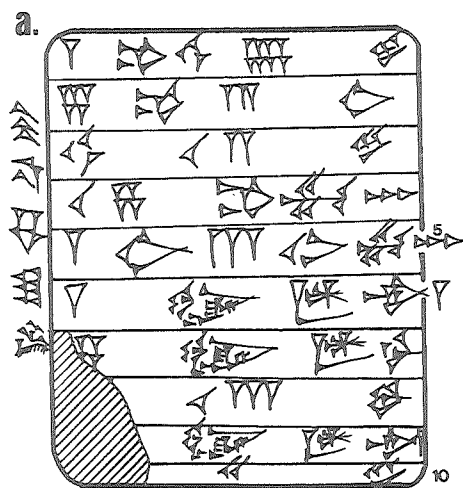

33 (MM 123)

AnOr 7 33
Drehem
ŠS2/xi/-

33. Sello:

Du₁₁-ga du[b-sar]
dumu Lu₂-[⁶Nin-gir₂-su]
sipa na-[kab]-tum

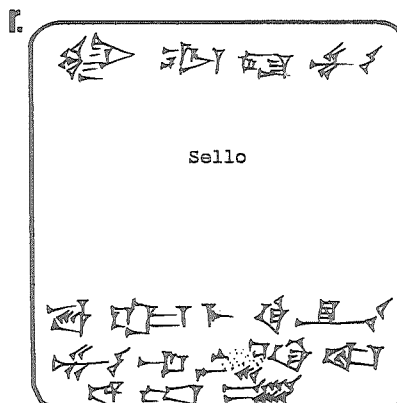
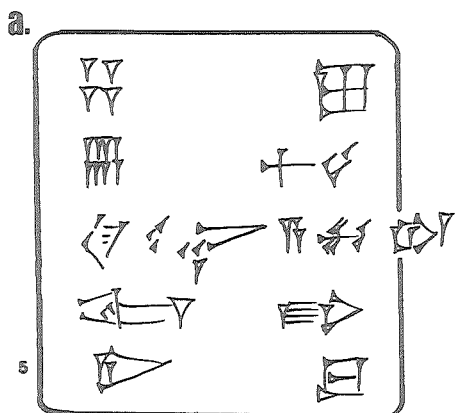

34 (MM 133)

AnOr 7 34
Drehem
ŠS3/i/25

34. Sello:

Ur-mes
dumu La-[na kurušda]

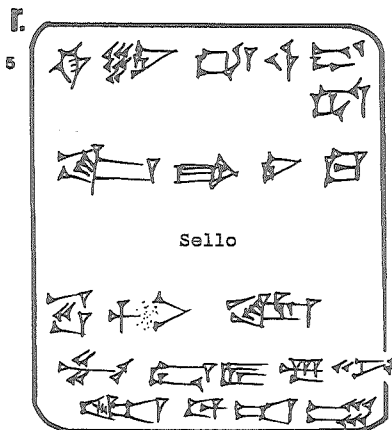
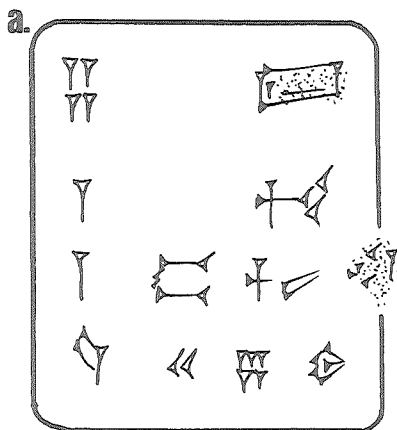

35 (MM 132)

AnOr 7 35
Drehem
ŠS3/vi/25,26

35. Sello:

Ur-mes
dumu La-[na kurušda]

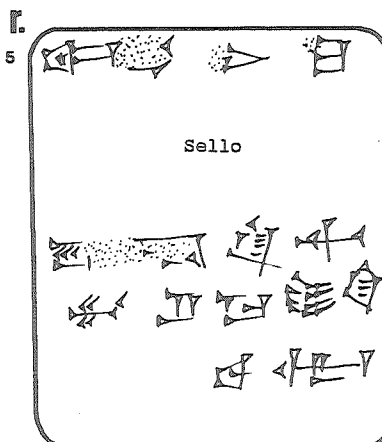
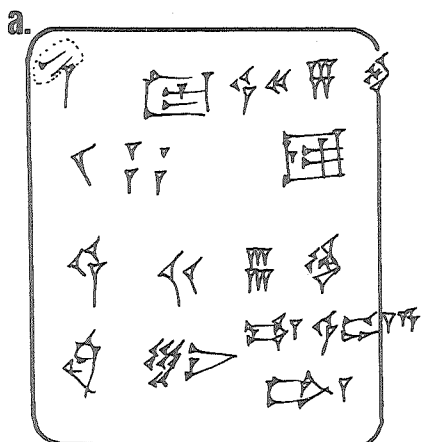

36 (MM 135)

36. Sello:

AnOr 7 36
Drehem
ŠS3/viii/29

Ur-⁴Iškur
dub-sar
dumu La-li₂-a

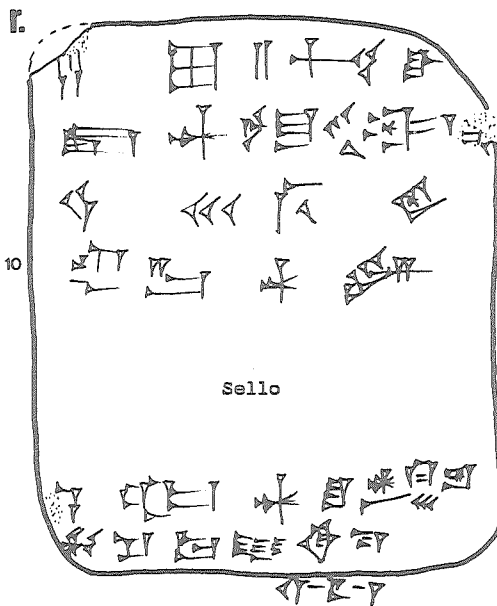
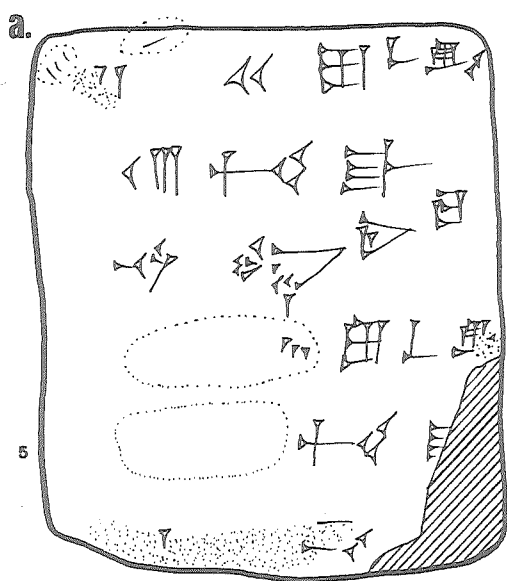

37 (MM 75b)

37. Sello:

AnOr 7 37
Drehem
ŠS3/ix/-

Ur-mes
dumu La-[na kurušda]

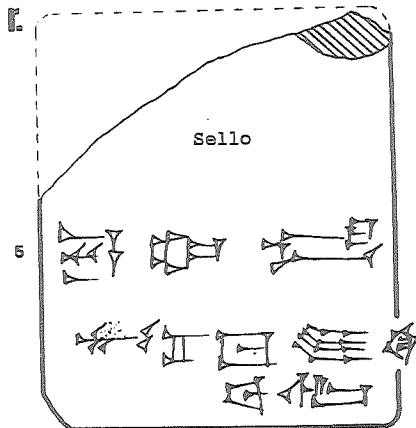
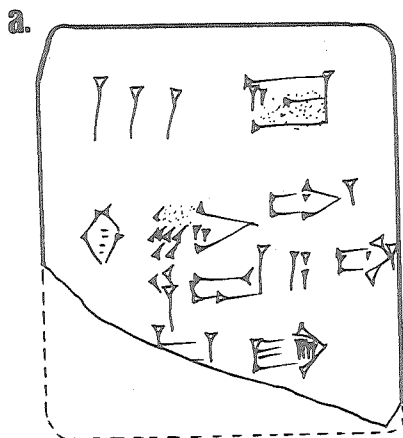

38 (MM 513)

AnOr 7 38
Drehem
ŠS4/ii/15

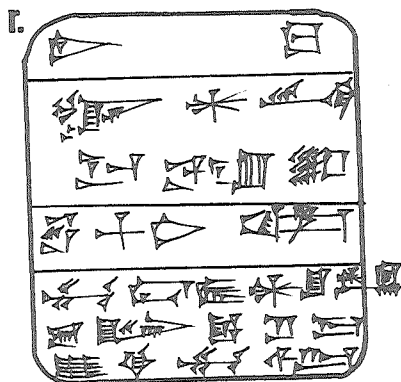
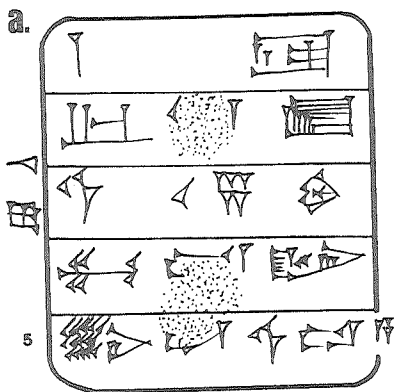

39 (MM. 131)

AnOr 7 39
Drehem
ŠS4/iii/-

39. Sello:

- i Šu-⁴EN./ZU
lugal kal-ga
lugal Uri,⁴ma
- ii Ta₂-hi-iš-/a-tal
maš₂-šu-gid₂-/gid₂
arad₂-[zu]

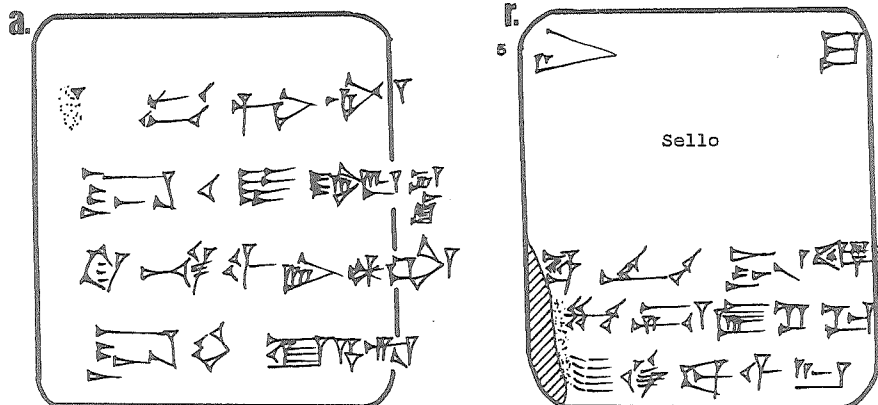

40 (MM 40)

AnOr 7 40
Drehem
Š38/xi/-

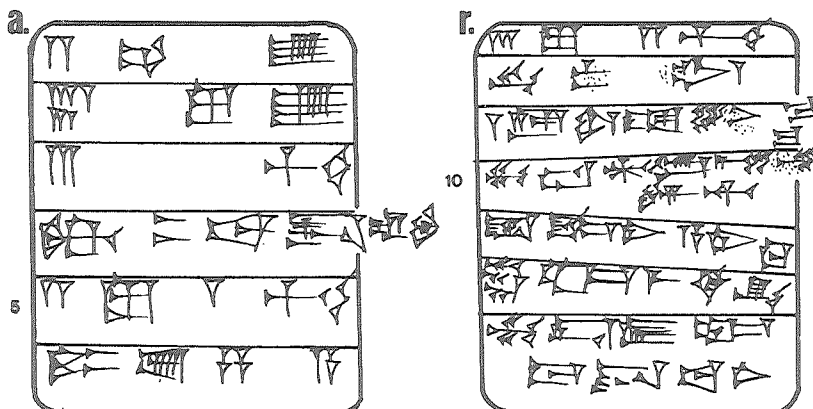

42 (MM 39)

AnOr 7 42
Drehem
Š38/viii/-

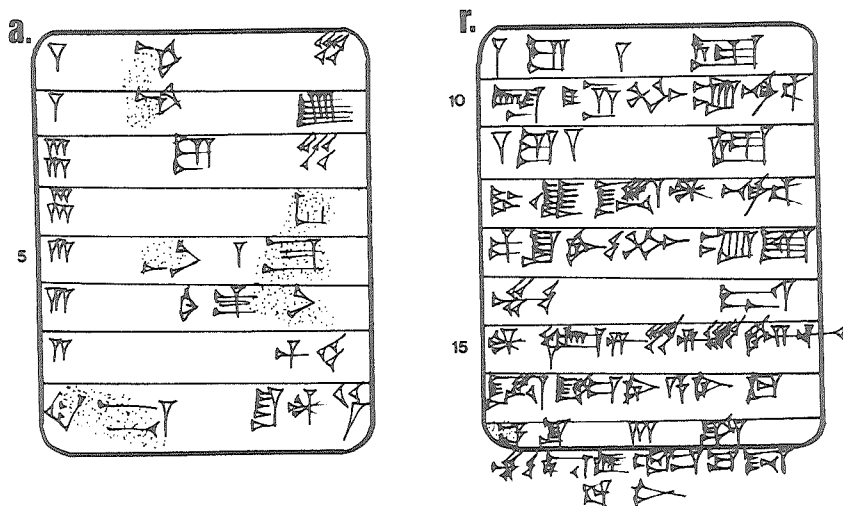

41 (MM 141)

AnOr 7 41
Drehem
SS6/V/1-26

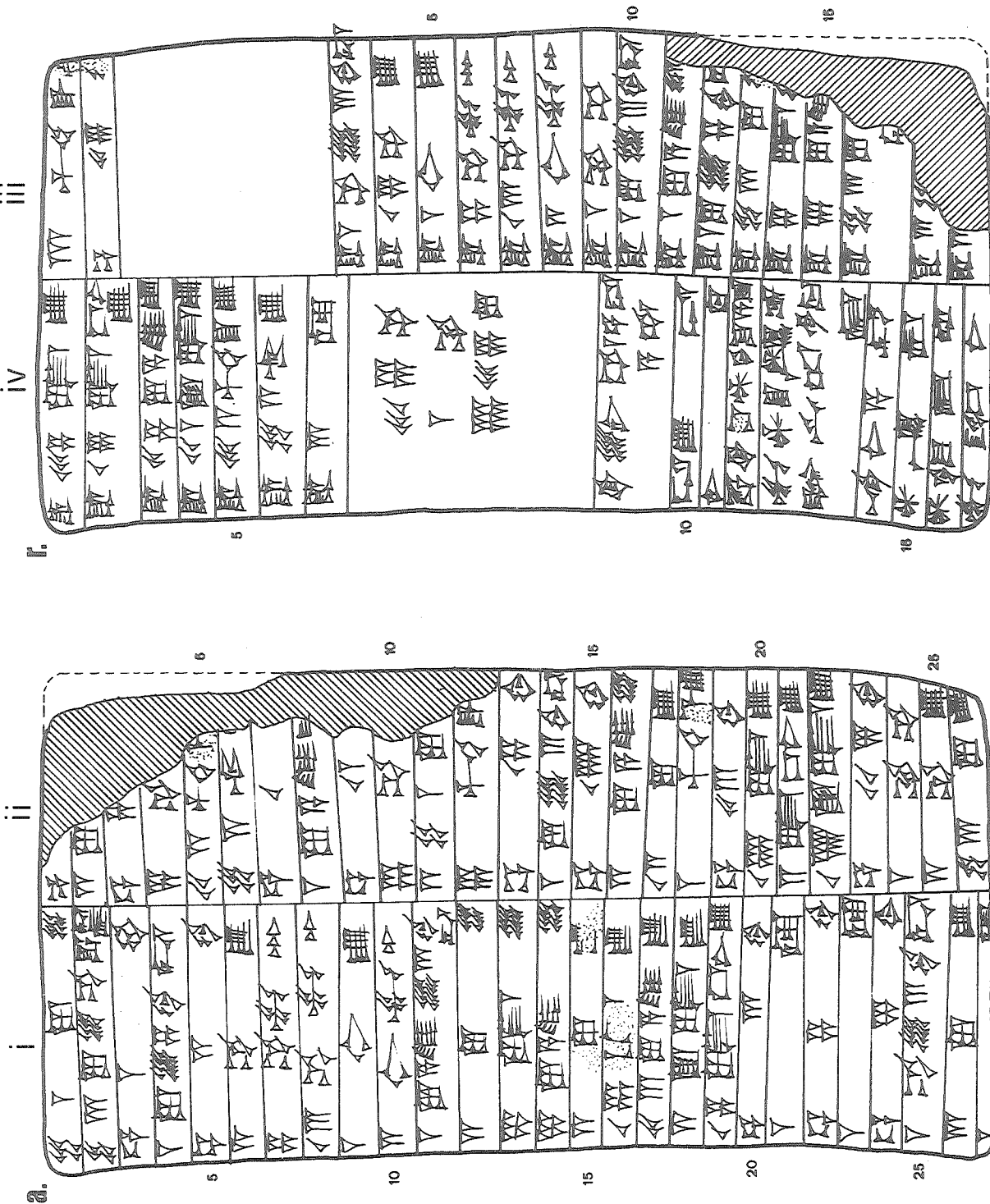

45 (MM 50)

AnOr 7 45
Drehem
ŠS9/ix/-

45. Sello:

- i Šu-^dSuen
lugal kal-ga
lugal Uri,^{ki}-ma
lugal ^dUb-/da limmu₂-ba
- ii Ur-ku₃-nun-na
dub-sar
dumu Lu₂-^dNin-gir₂-/su kurušda
arad₂-zu

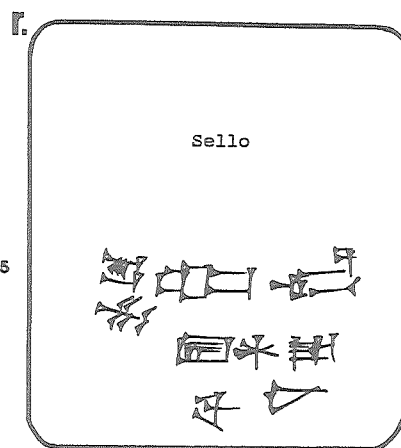
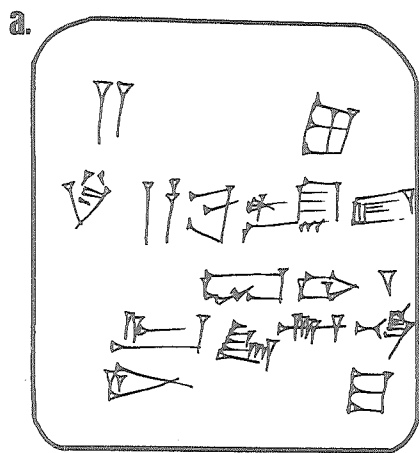

46 (MM 149) a.

AnOr 7 46
Drehem
ŠS9/x/-

46. Sello:

- i Šu-^dSuen
lugal kal-ga
lugal Uri,^{ki}-ma
lugal ^dUb-/da limmu₂-ba
- ii Ur-ku₃-nun-na
dub-sar
dumu Lu₂-^dNin-gir₂-/su kurušda
arad₂-zu

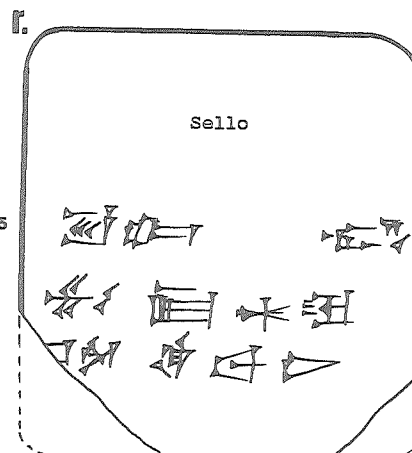
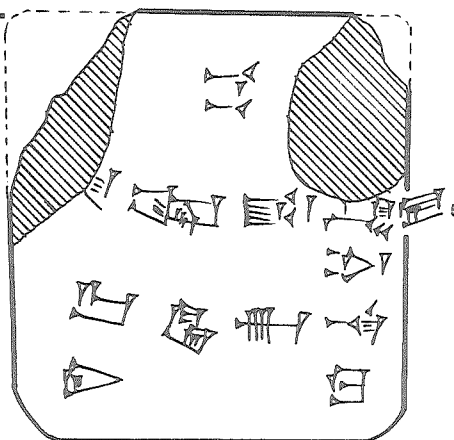

47 (MM 156)

AnOr 7 47
Drehem
ŠS9/xii/25

47. Sello:

Du₁₁-ga dub-sar
dumu Lu₂-^dNin-gir₂-su
sipa na-kab-tum

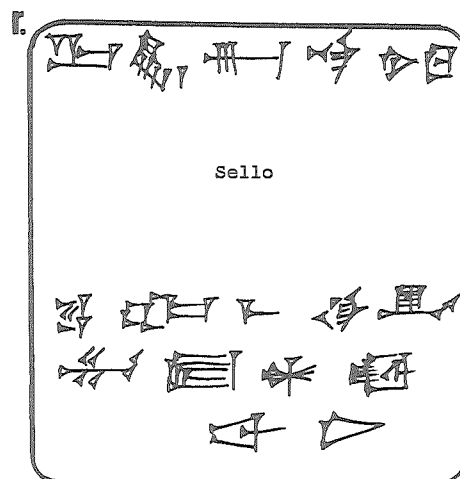
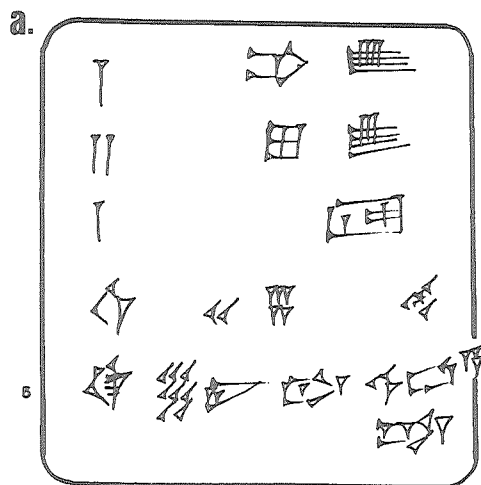

48 (MM 162)

AnOr 7 48
Drehem
IS1/iii/11

48. Sello:

- i ⁴Šu-⁴Suen
[lugal] kal-ga
[lugal] Uri₃/^{ki}-ma
[lugal] ⁴Ub-/da limmu₂-ba
- ii ⁴Nan[na-ma-b]a
dub-sar
dumu U₂-n[a-a]p-/še-en
arad₂-zu

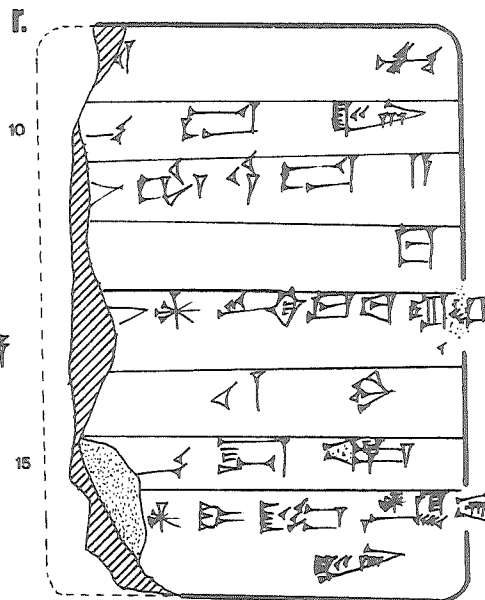
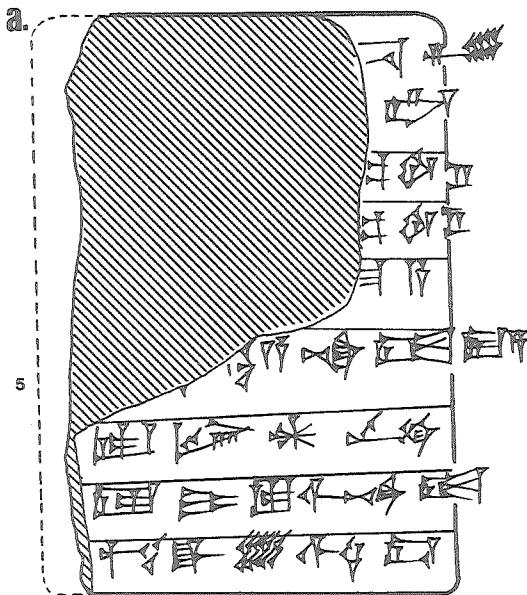

49 (MM 160)

AnOr 7 49
Drehem
IS1/vii/-

49. Sello:

- i ⁴Šu-⁴Suen
lugal kal-ga
lugal Uri₃/^{ki}-ma
lugal ⁴Ub-/da
limmu₂-ba
- ii Ur-ku₂-nun-na
dub-sar
dumu Lu₂-⁴Nin-gir₂-su kurušda
arad₂-zu

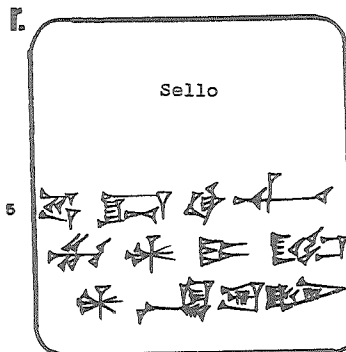
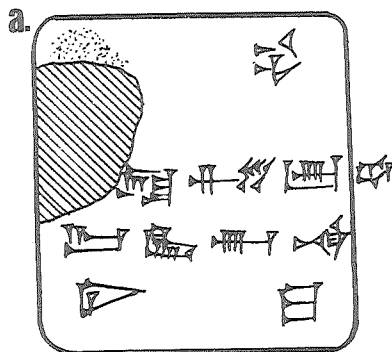

50 (MM 70)

AnOr 7 50
Drehem?
-/-

50. Sello:

A-hu-ni-...]
ar[ad_{1/2} ...]

Etiqueta con orificio transversal para cuerda

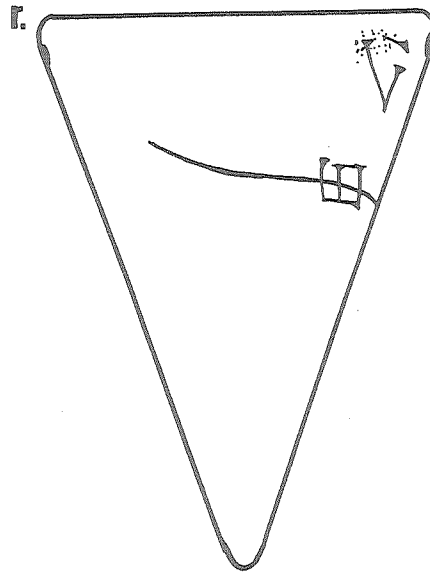
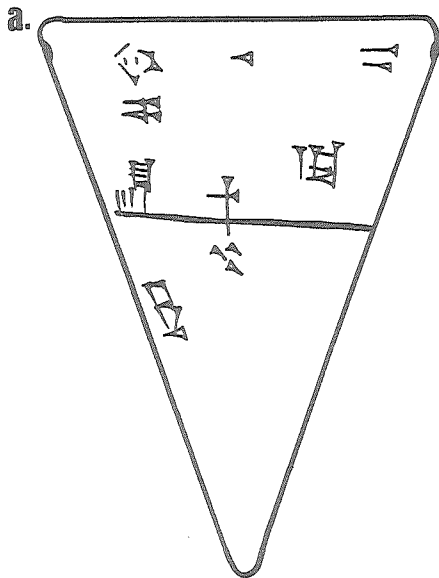

51 (MM 157)

AnOr 7 51
Drehem
ŠS9/x/-

51. Sello:

- i ⁴Šu-⁴Suen
lugal kal-ga
lugal Uri₃/⁴ma
lugal ⁴Ub-/da
limmu₂-ba
- ii Ur-ku₃-nun-na
dub-sar
dumu Lu₂-⁴Nin-gir₂-/su kurušda
arad₂-zu

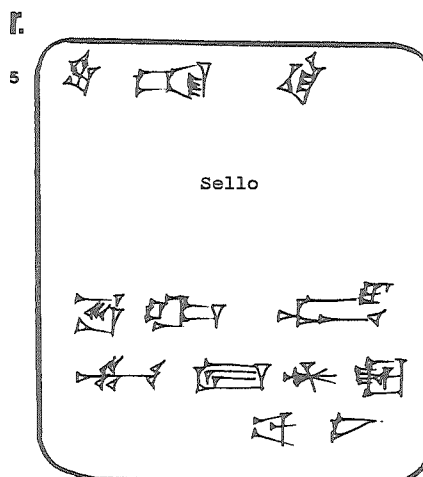
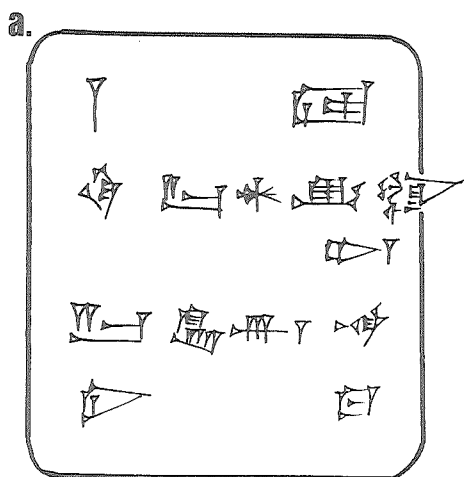

52 (MM 24)

AnOr 7 52
Drehem
§32/xi/-

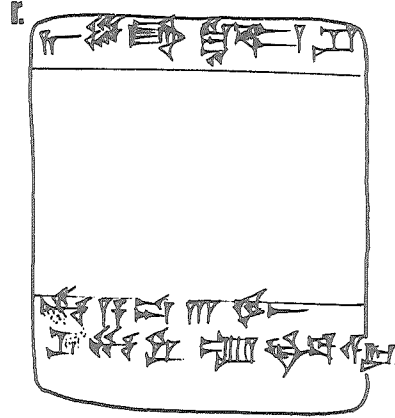
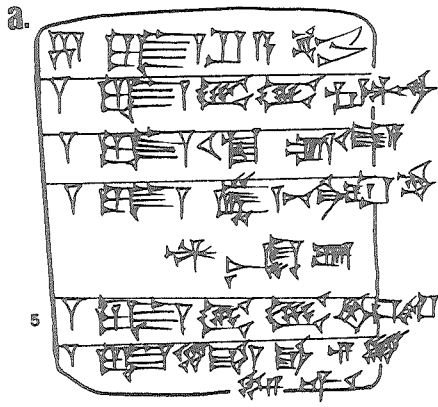

53 (MM 25)

AnOr 7 53
Drehem
§33/ix/-

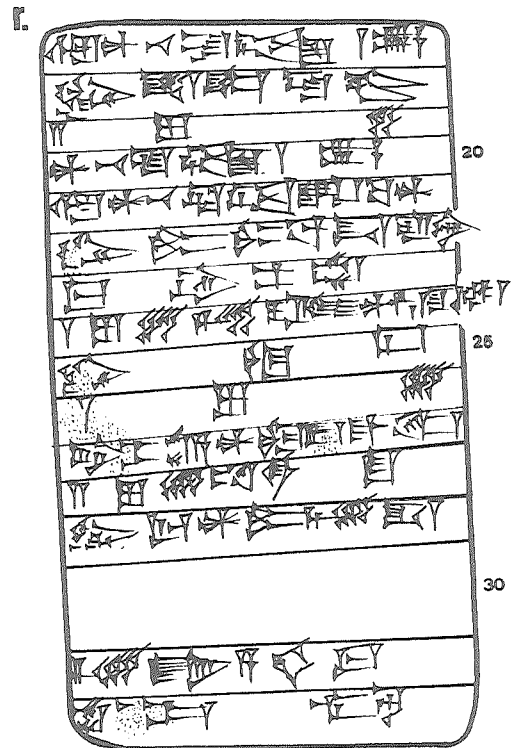
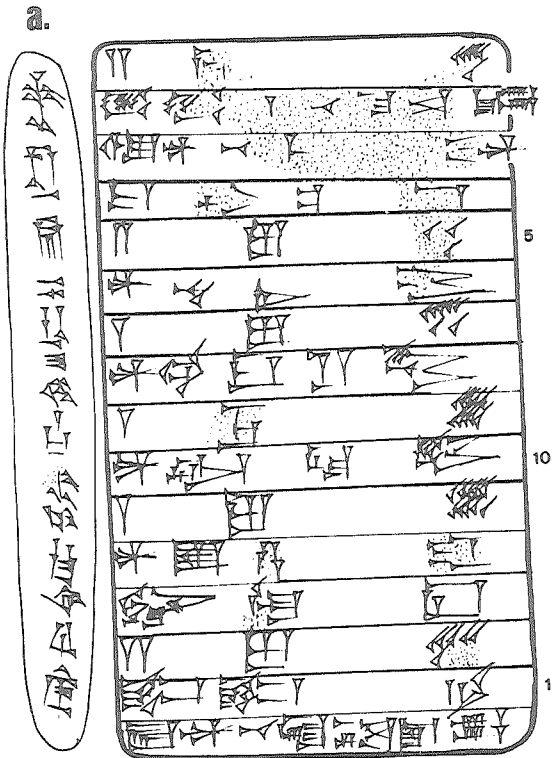

54 (MM 545)

AnOr 7 54
Umma?
Š35/-/-

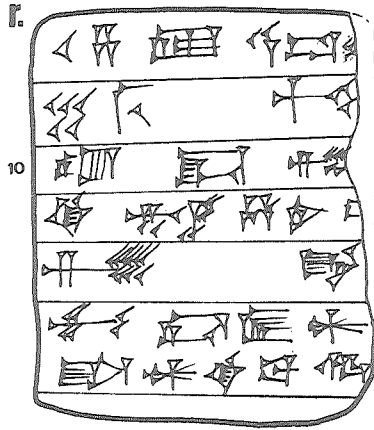
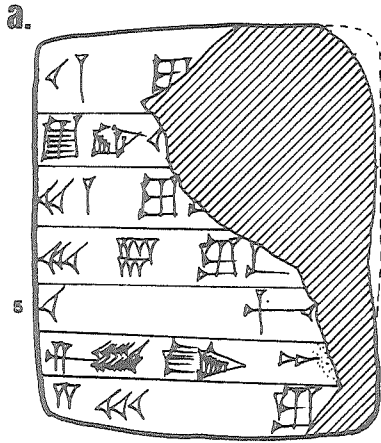

55 (MM 29)

AnOr 7 55
Drehem
Š35/vi/-

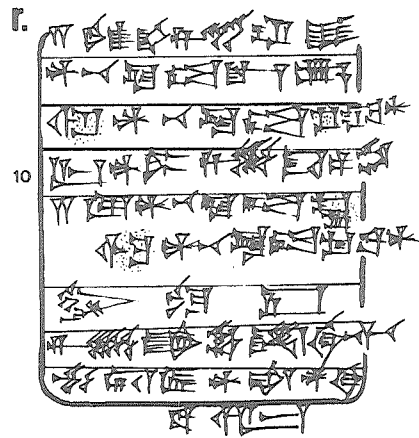
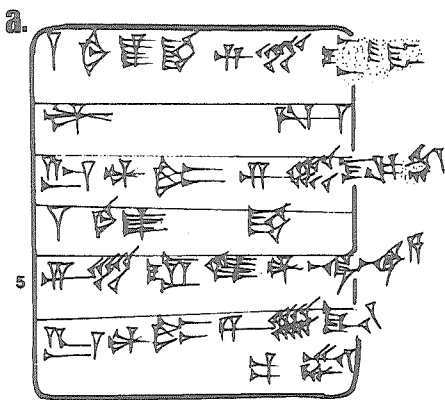

56 (MM 28)

AnOr 7 56
Drehem
Š35/x/-

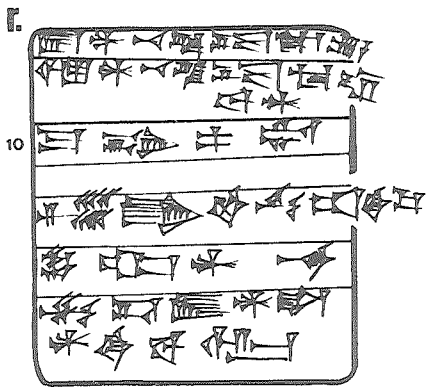
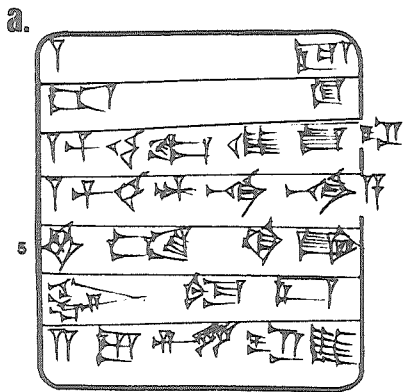

57 (MM 31)

AnOr 7 57
Drehem
Š36/1/-

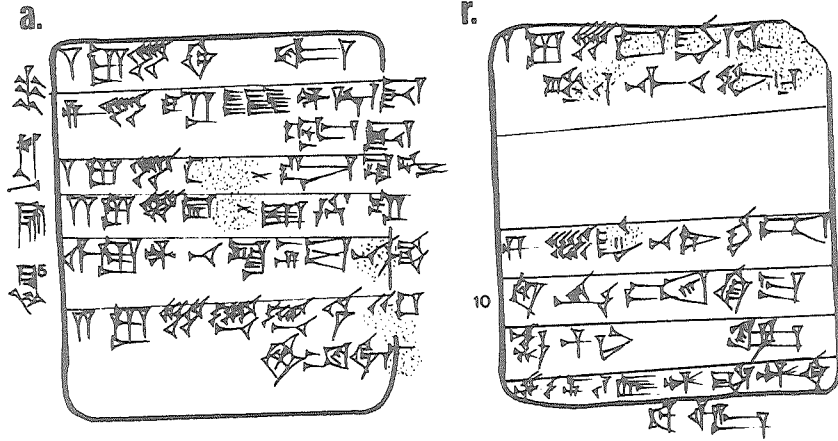

58 (MM 30)

AnOr 7 58
Drehem
Š36/1/-

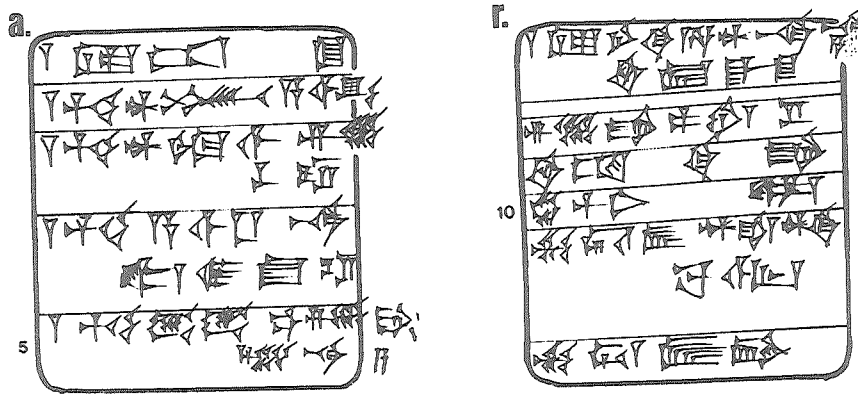

59 (MM 34)

AnOr 7 59
Drehem
Š36/iv/-

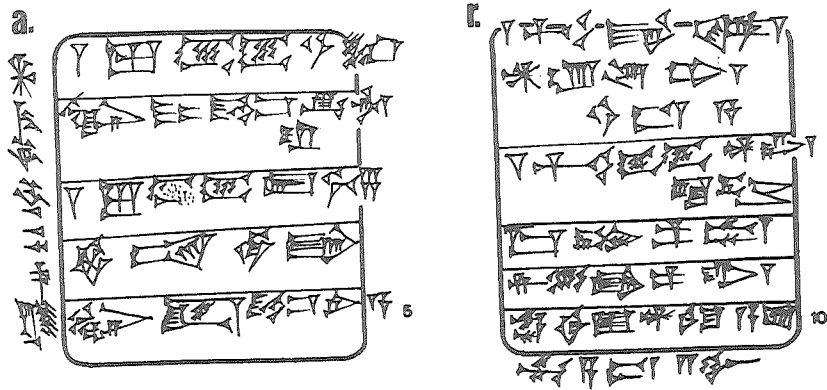

60 (MM 32)

AnOr 7 60
Drehem
Š36/ix/1-2

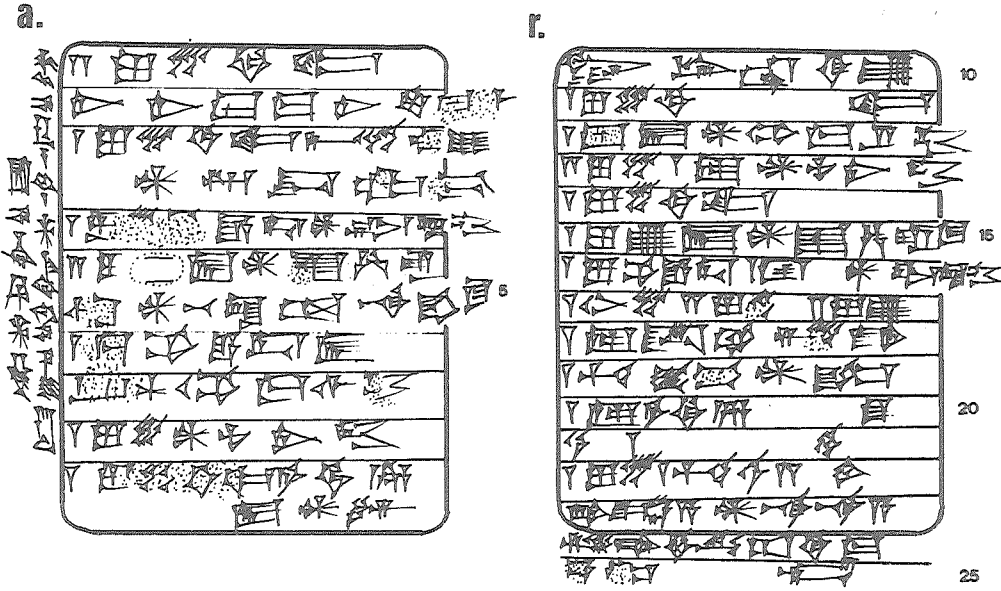

61 (MM 37)

AnOr 7 61
Drehem
Š37/v/-

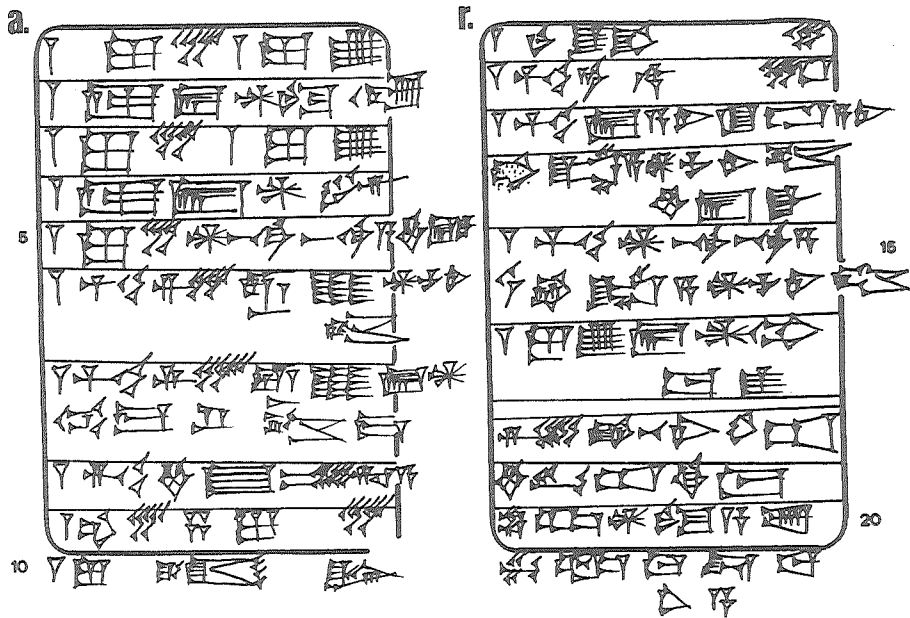

62 (MM 38)

AnOr 7 62
Drehem
Š37/vi/-

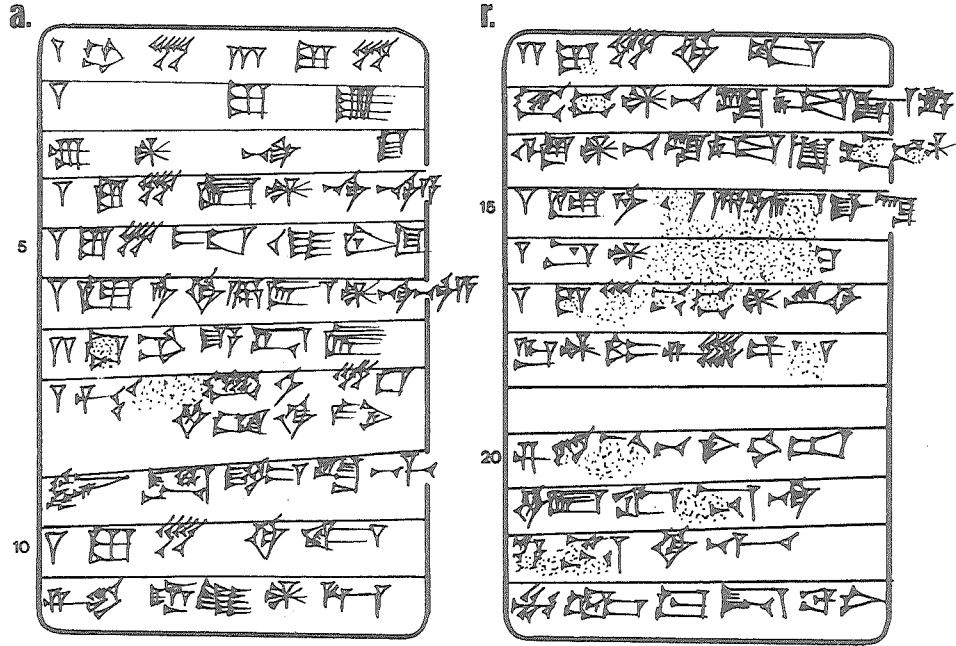

63 (MM 43)

AnOr 7 63
Drehem
Š40/iii/1

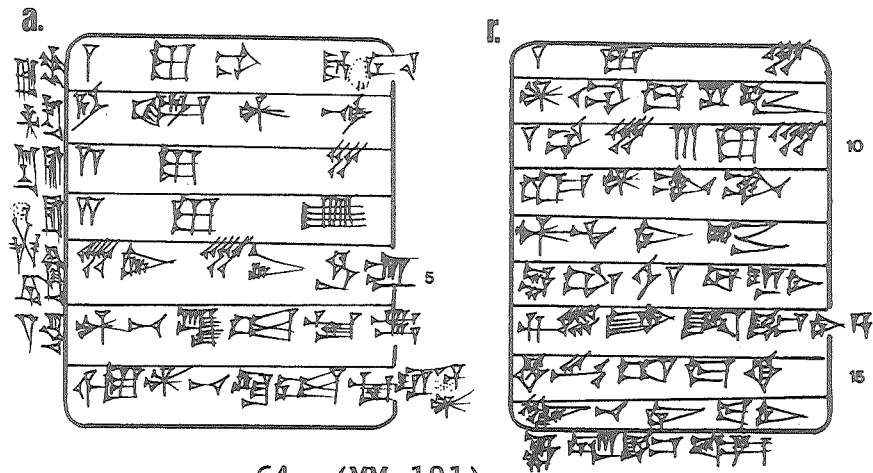

64 (MM 191)

AnOr 7 64
Drehem
Š41/ix/6,10

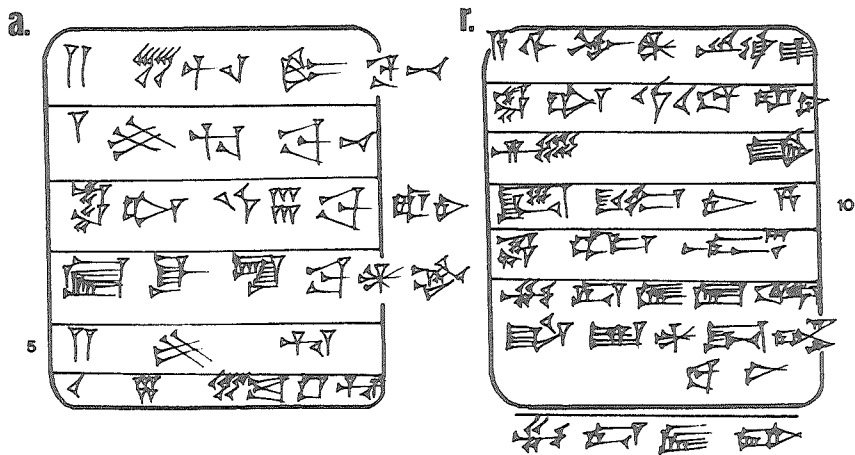

65 (MM 46)

AnOr 7 65
Drehem
Š40/ix/30

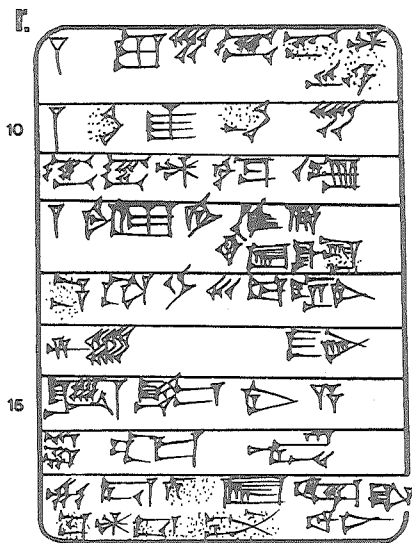
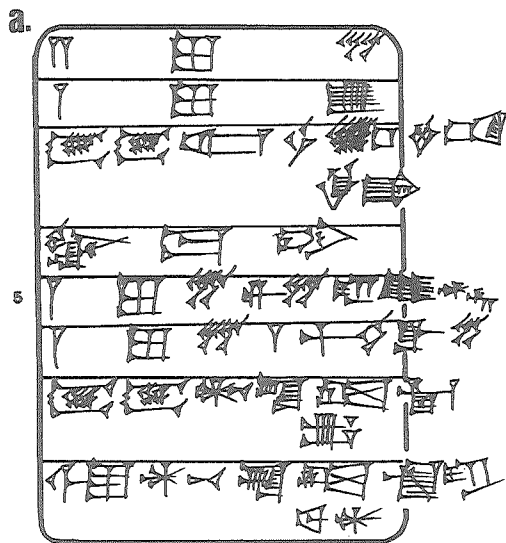

66 (MM 42)

AnOr 7 66
Drehem
Š40/x/28

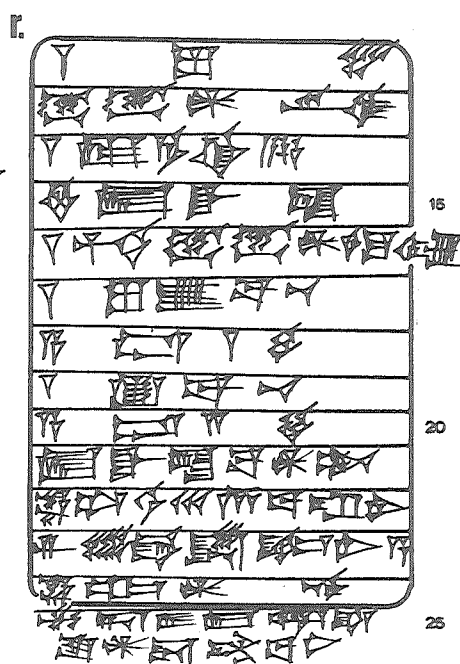
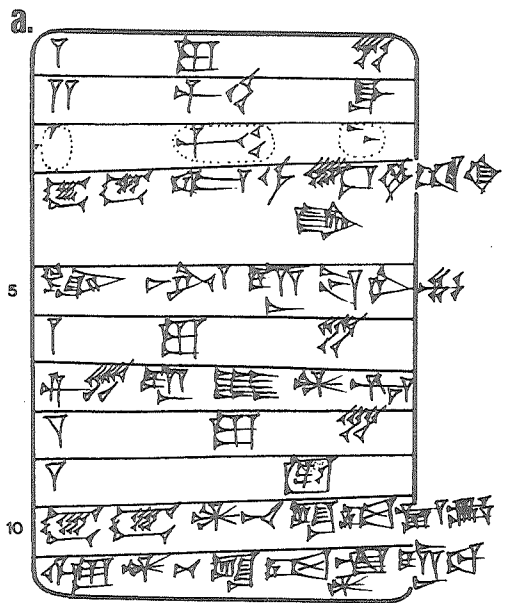

67 (MM 45)

AnOr 7 67
Drehem
Š41/ii/20

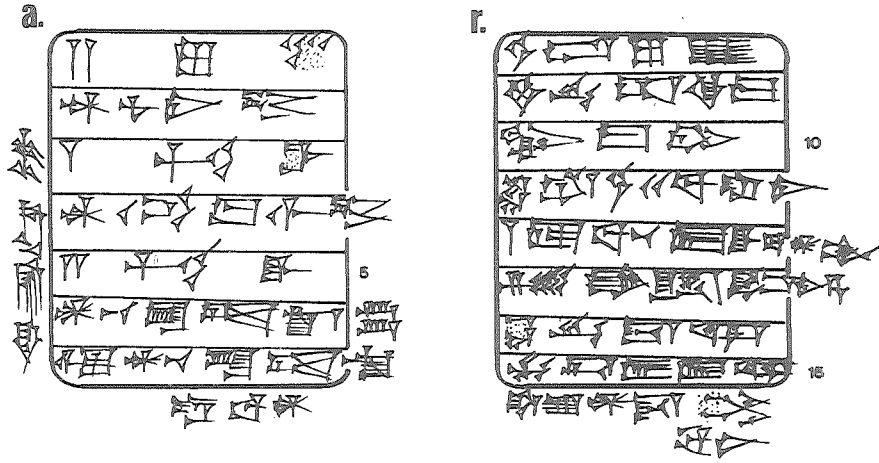

68 (MM 47)

AnOr 7 68
Drehem
Š41/ii/4

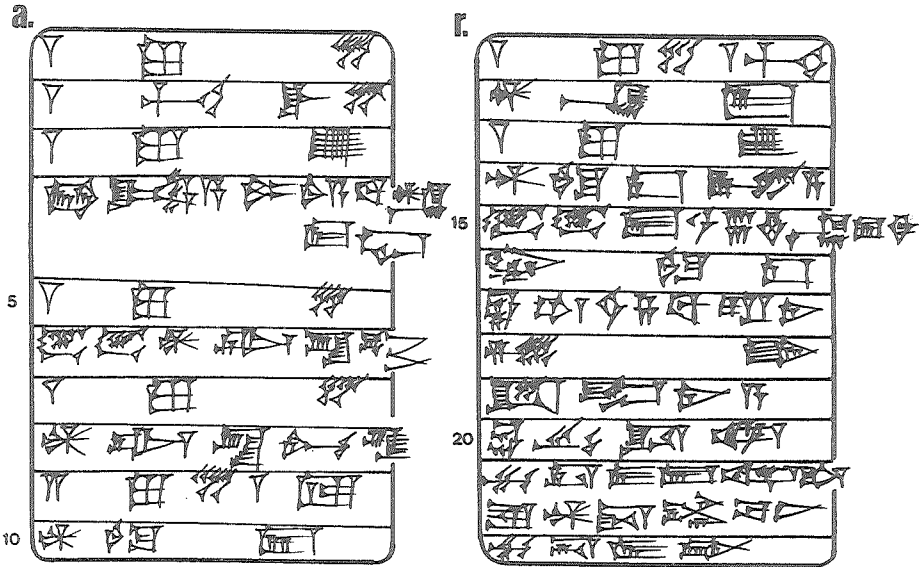

69 (MM 48)

AnOr 7 69
Drehem
Š41/vii/2

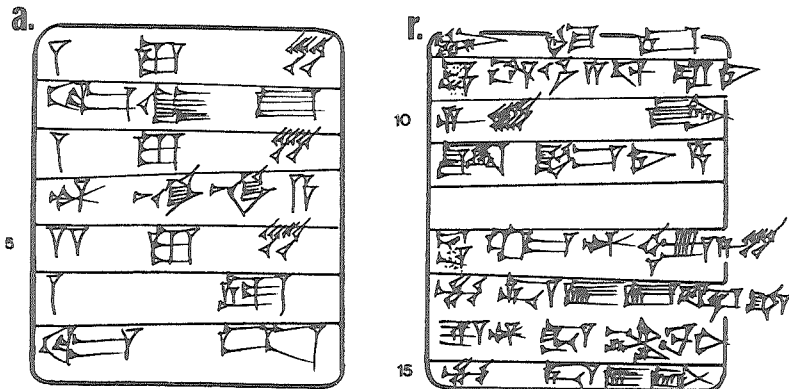

70 (MM 55)

AnOr 7 70
Drehem
Š43/ii/11-17

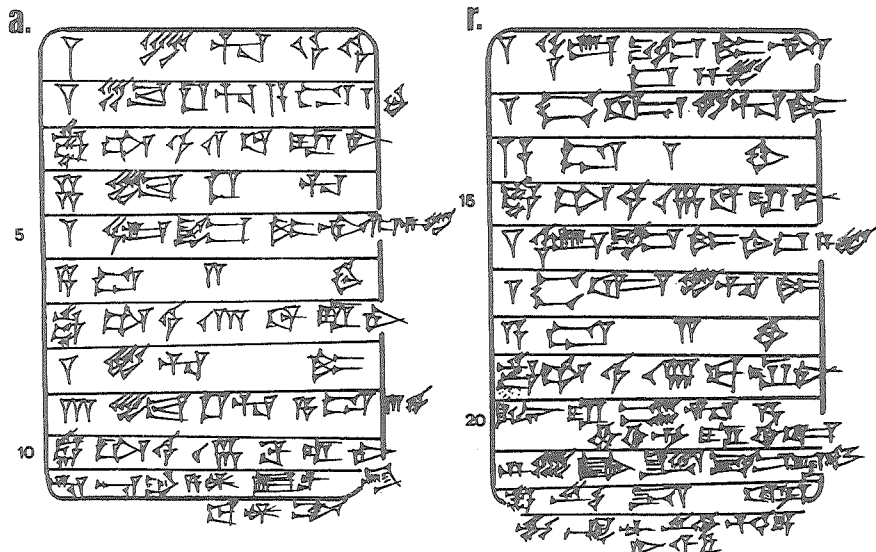

71 (MM 56)

AnOr 7 71
Drehem
Š43/x/4,5

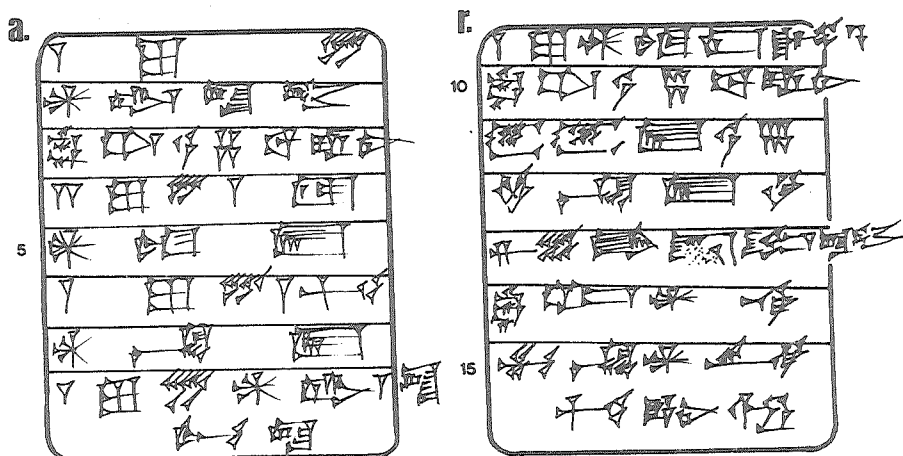

72 (MM 67)

AnOr 7 72
Drehem
Š45/vii/10,15

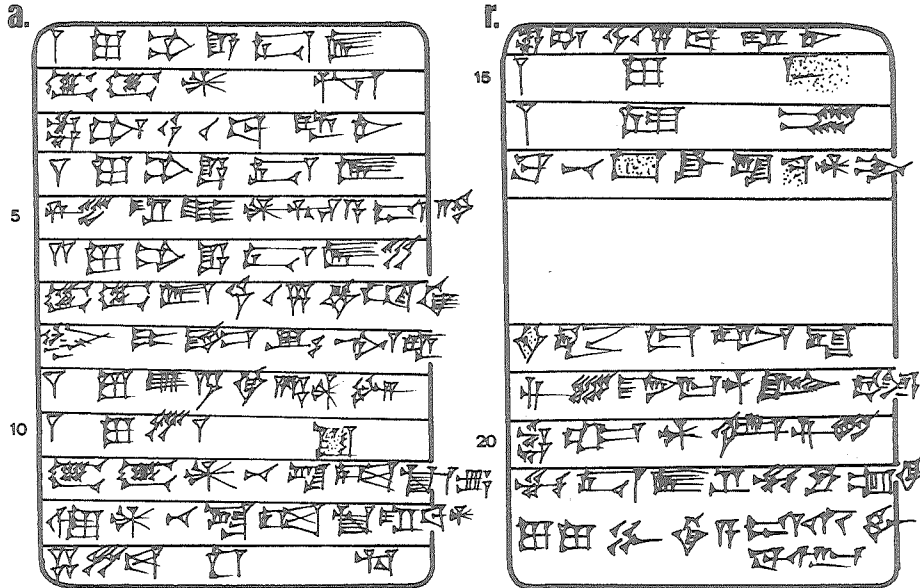

73 (MM 71)

AnOr 7 73
Drehem
Š45/ix/13

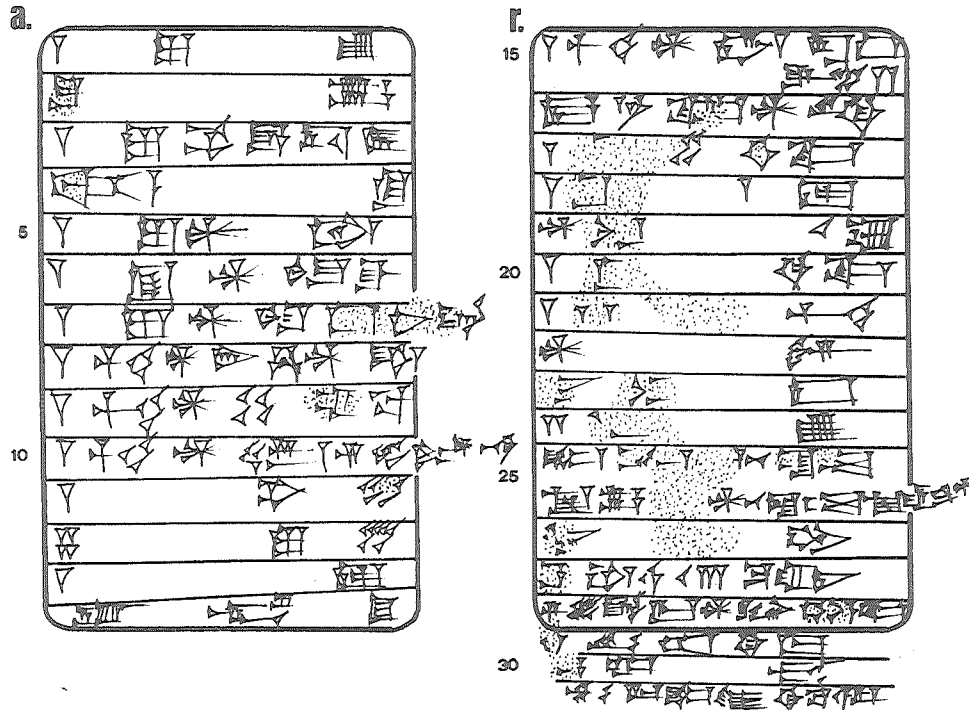

74 (MM 65)

AnOr 7 74
Drehem
Š45/ix/30

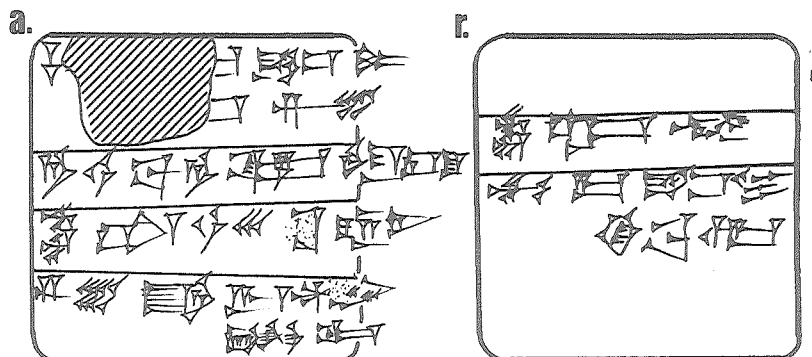

75 (MM 82)

AnOr 7 75
Drehem
Š46/viii/27

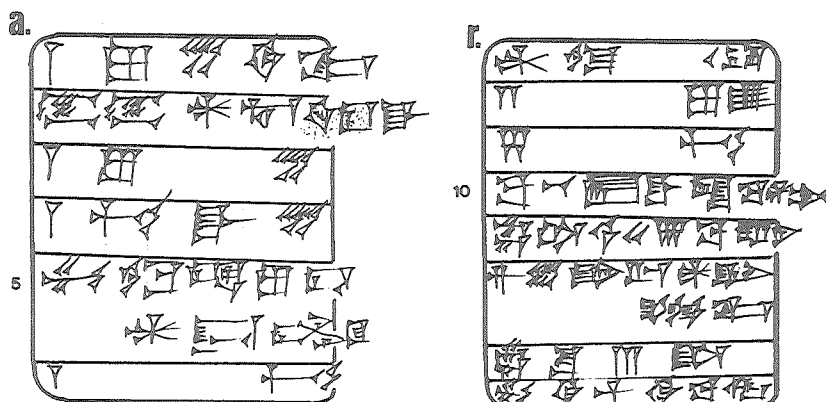

76 (MM 79)

AnOr 7 76
Drehem
Š46/xi/8,9

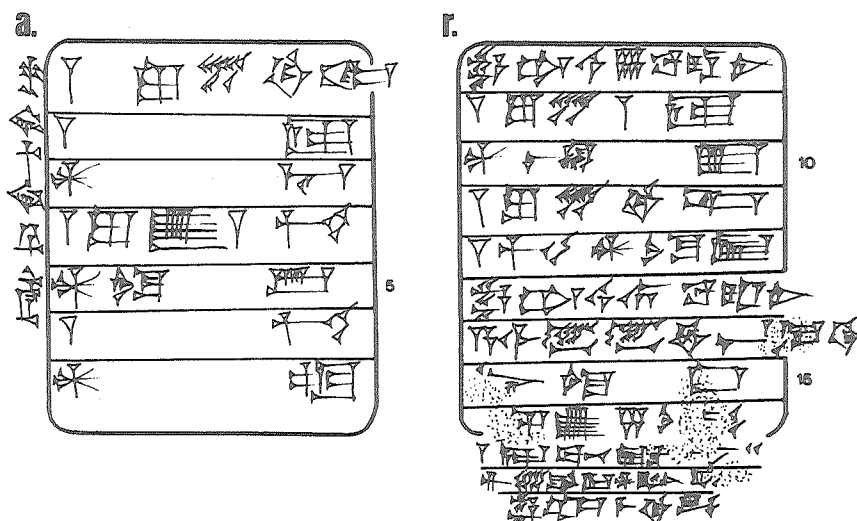

77 (MM 81)

AnOr 7 77
Drehem
Š46/xi/15

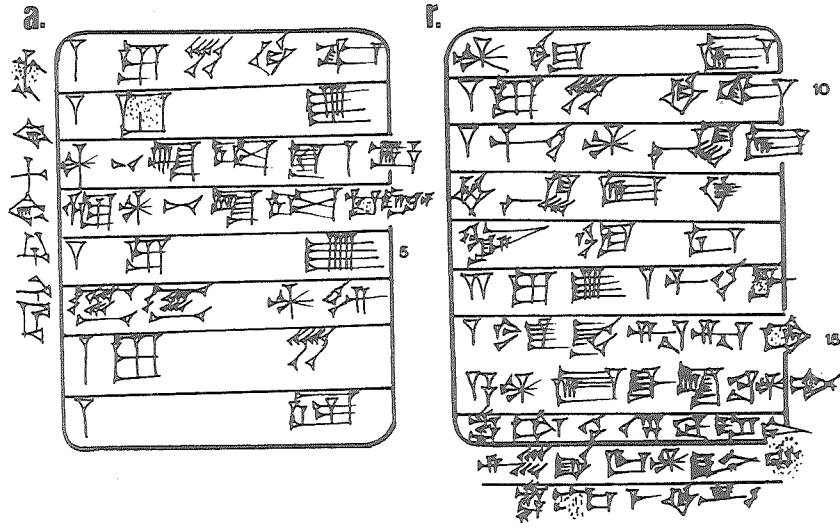

78 (MM 72)

AnOr 7 78
Drehem
Š46/xii/-

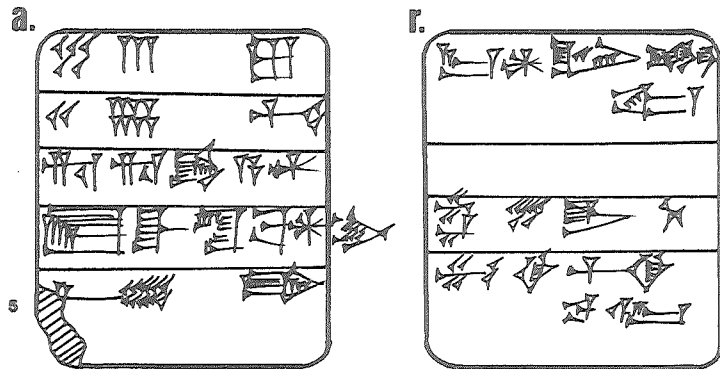

79 (MM 201)

AnOr 7 79
Drehem
Š46/xii/9

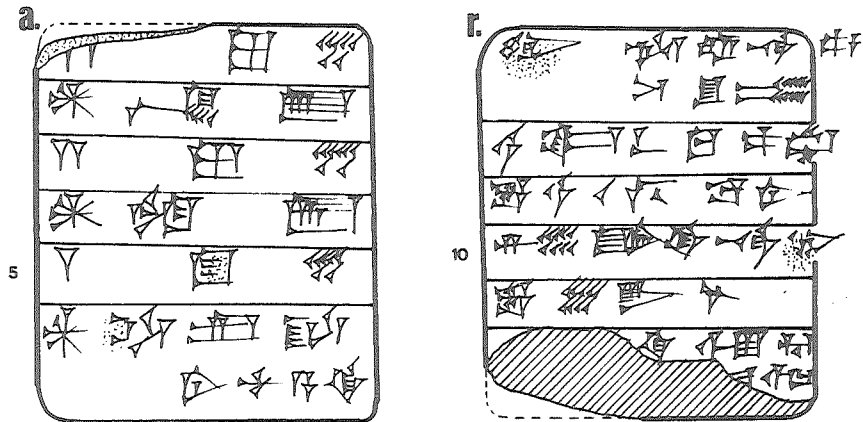

80 (MM 78)

AnOr 7 80
Drehem
Š46/xii/13,14

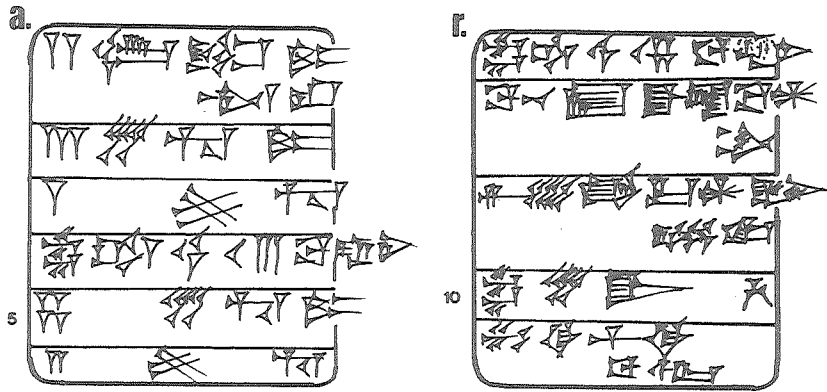

81 (MM 432)

AnOr 7 81
Drehem
Š47/iii/15

Perdido aprox. 1/3 de la tablilla

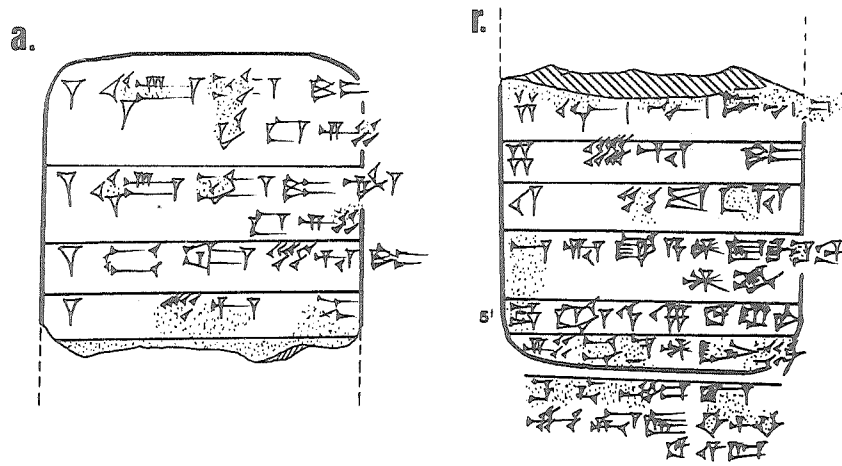

82 (MM 95)

AnOr 7 82
Drehem
Š47/iii/14

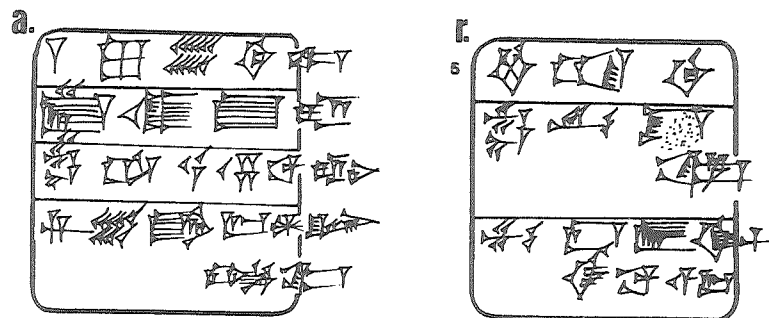

83 (MM 92)

AnOr 7 83
Drehem
Š47/vi/19,21

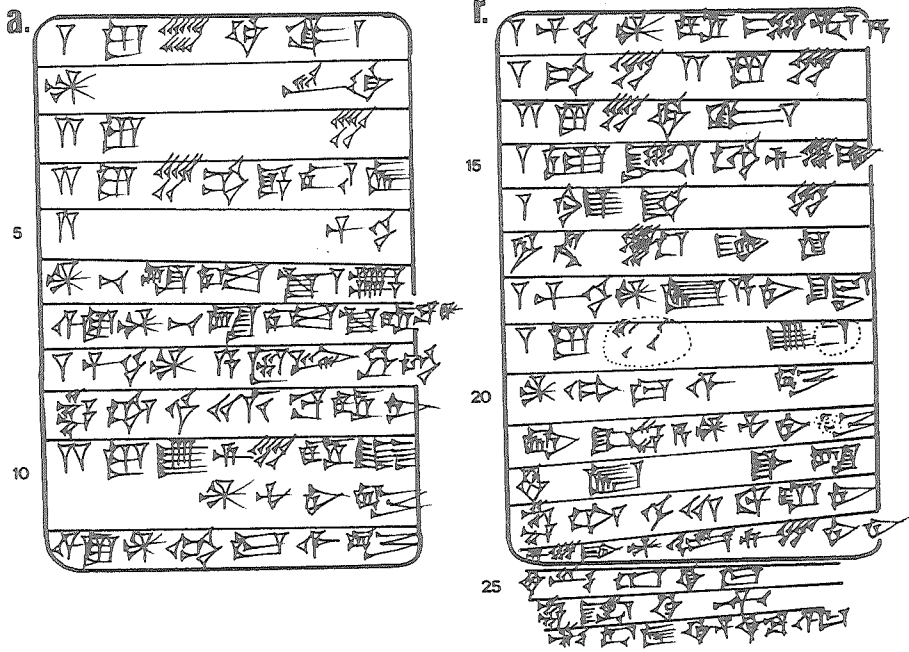

84 (MM 83)

AnOr 7 84
Drehem
Š47/vi/22

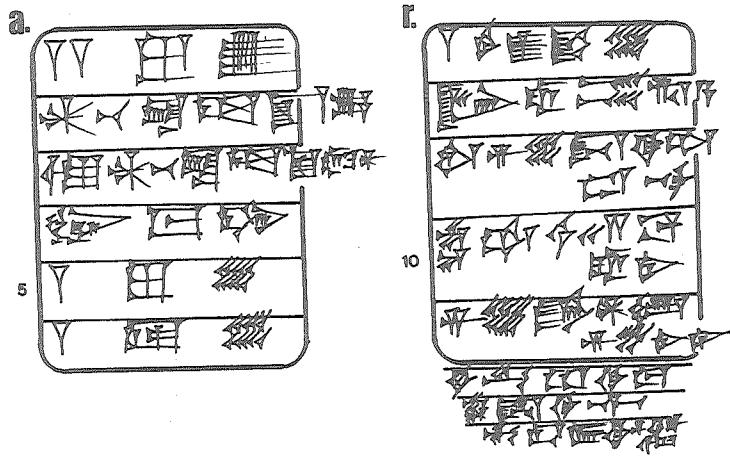

85 (MM 85)

AnOr 7 85
Drehem
Š47/ix/-

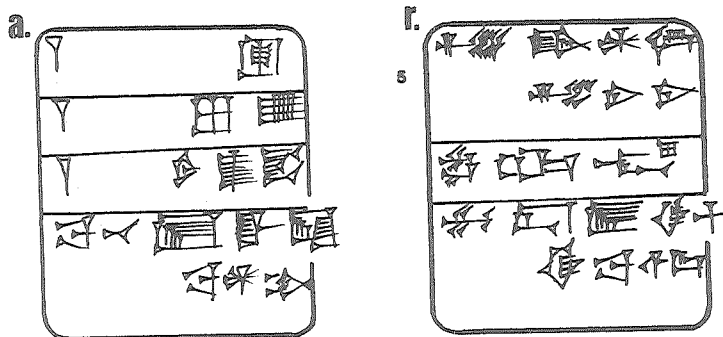

86 (MM 91)

AnOr 7 86
Drehem
Š47/xi/7

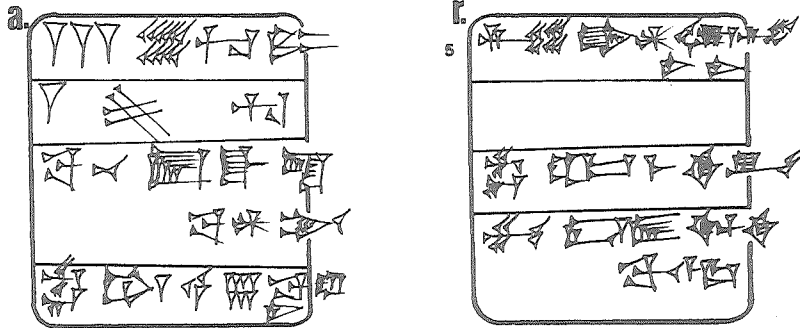

87 (MM 87)

AnOr 7 87
Drehem
Š47/xi/7

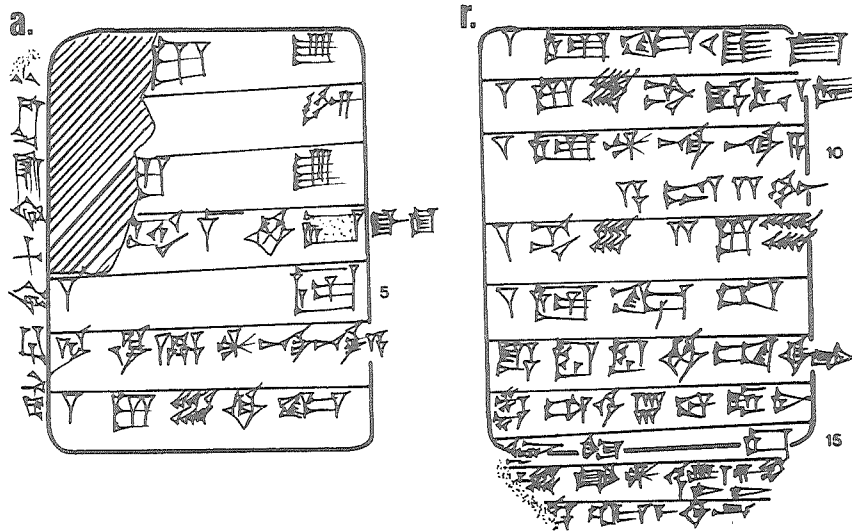

88 (MM 52)

AnOr 7 88
Drehem
Š43/i/15,19,22

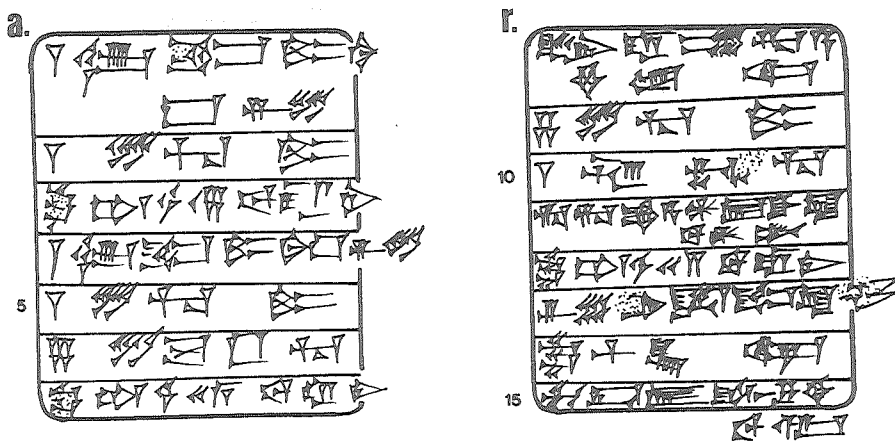

89 (MM 36)

AnOr 7 89
Drehem
Š37/viii/-

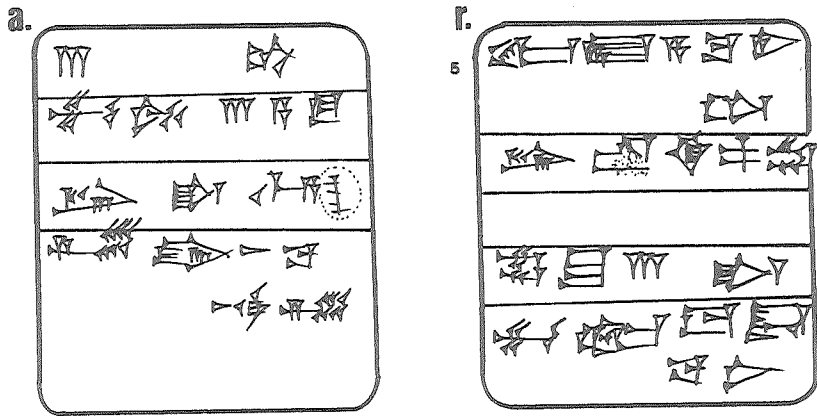

90 (MM 181)

AnOr 7 90
Drehem
-vii/14

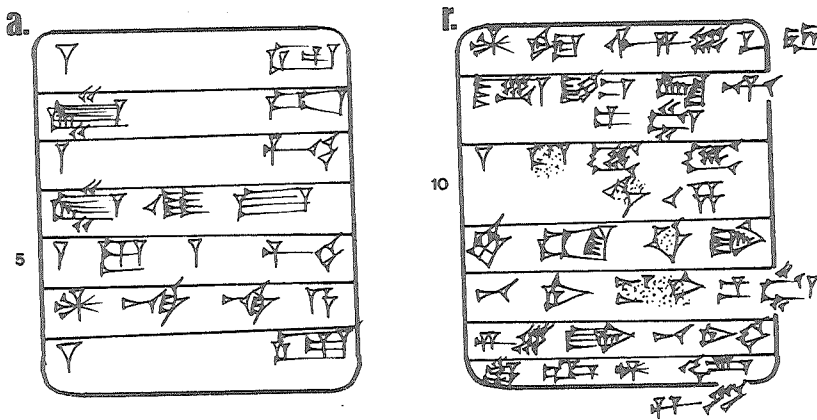

91 (MM 51)

AnOr 7 91
Drehem
Š41/viii/-

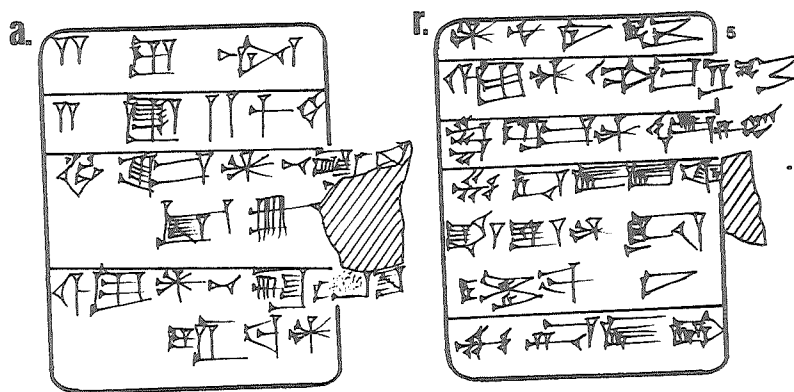

92 (MM 524)

AnOr 7 92
Drehem
Š34/ii/-

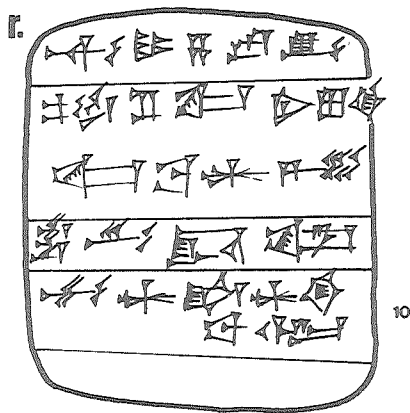
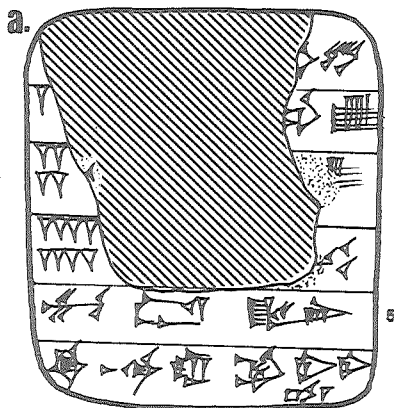

93 (MM 221)

AnOr 7 93
Drehem
AS6/v-xii/18

Bulla con orificios para cuerda

93. Sello:

i ^dAmar-^dSuen
nita kal-ga
lugal Uri,^{ba}-ma
lugal ^dUb-/da limmu₂-ba

ii Lugal-^{iti}-d[a]
dub-sar
dumu Ur-^dDumu-/^{zi}-d[a]
^{arad}₂-[zu]

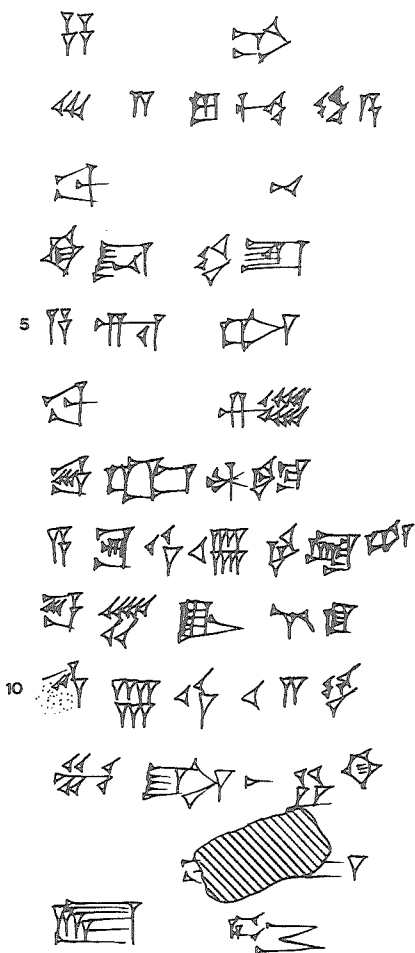
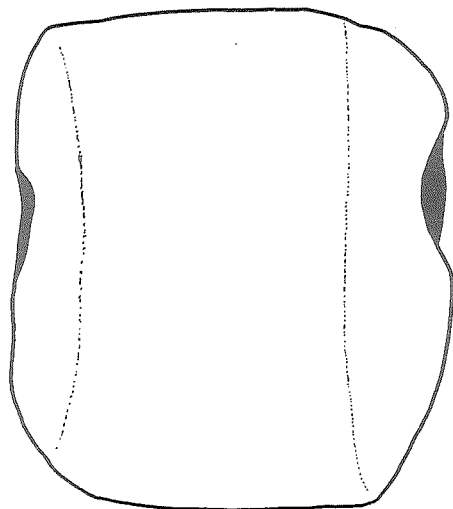

Sello

94 (MM 96)

AnOr 7 94
Drehem
Š48/vi/11

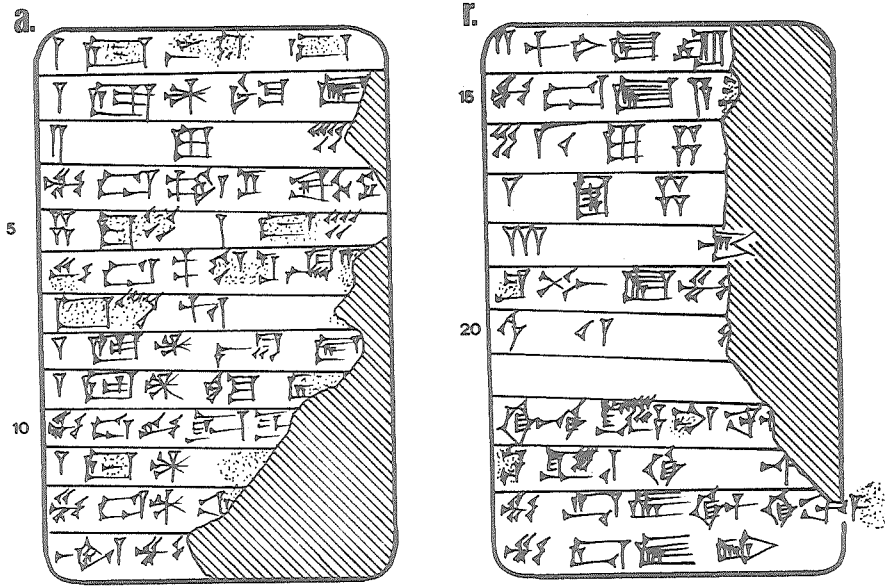

95 (MM 268)

AnOr 7 95
Drehem
Š48/ix/29

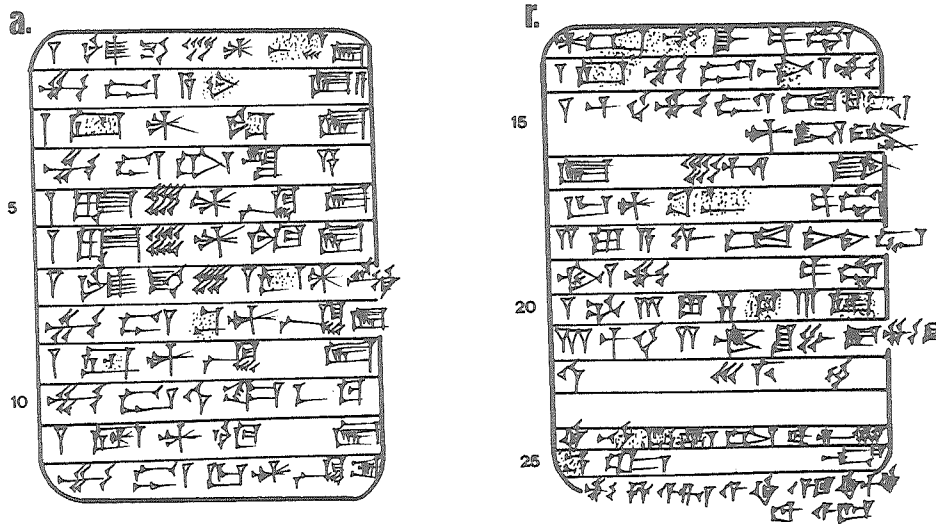

96 (MM 215)

AnOr 7 96
Drehem
AS2/iv/1

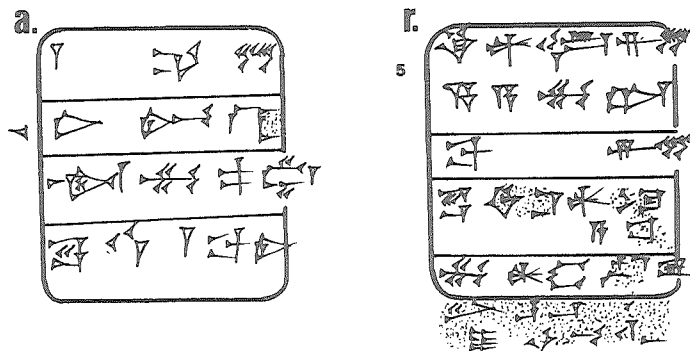

97 (MM 552)

AnOr 7 97
Drehem
AS2/v/23

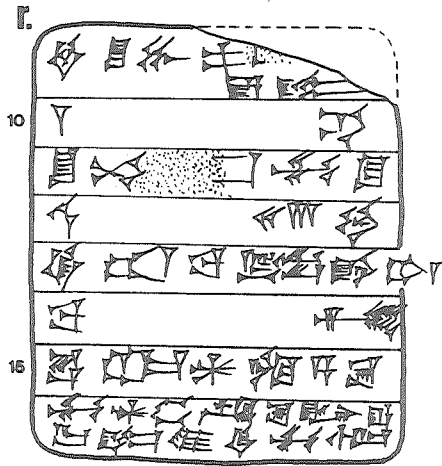
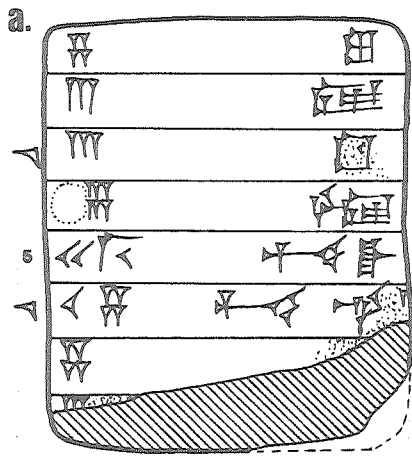

99 (MM 103)

AnOr 7 99
Drehem
AS4/v/6

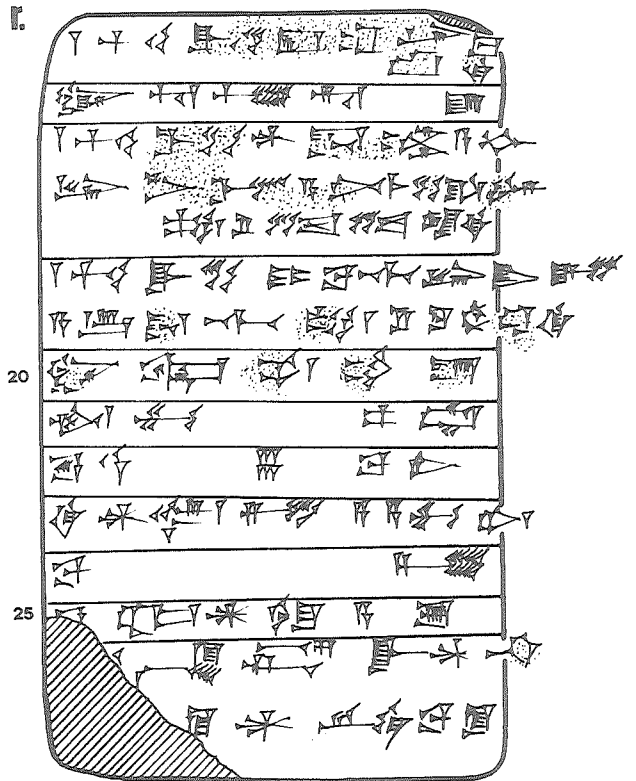
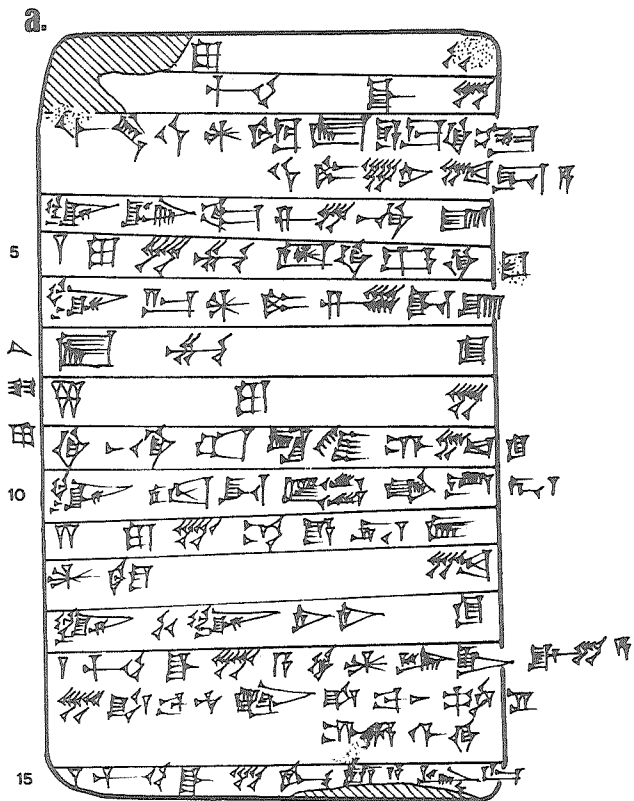

98 (MM 562)

AnOr 7 98
Drehem
AS2/viii/-

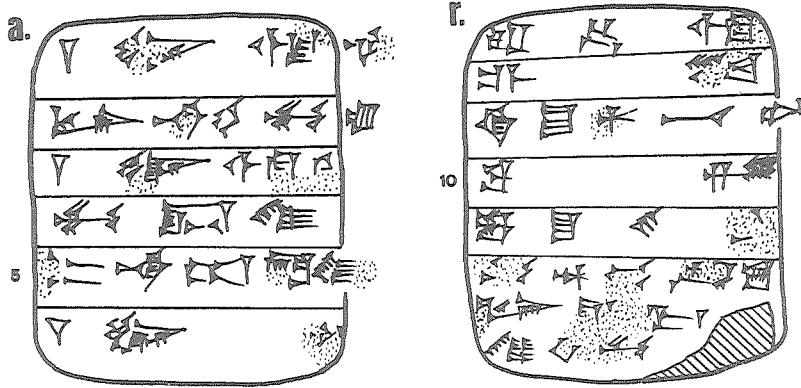

100 (MM 145)

AnOr 7 100
Drehem
ŠS7/x⁷/1-[]

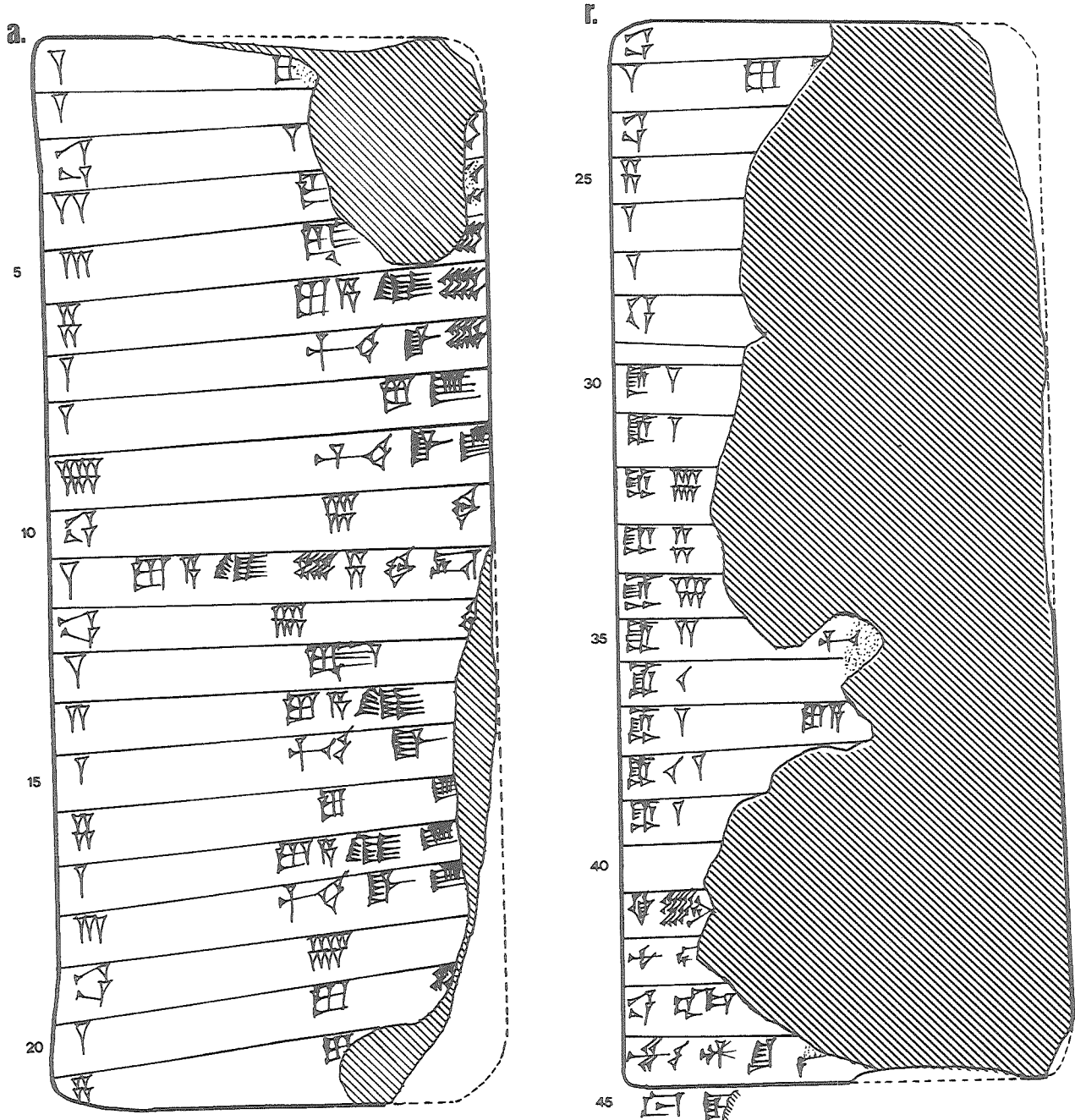

101 (MM 117)

AnOr 7 101
Drehem
ŠS1/xii/-

101. Sello:

Du₁₁-ga dub-[sar]
dumu Lu₂-^dNin-g[ir₂-su]
sipa na-kab-tum

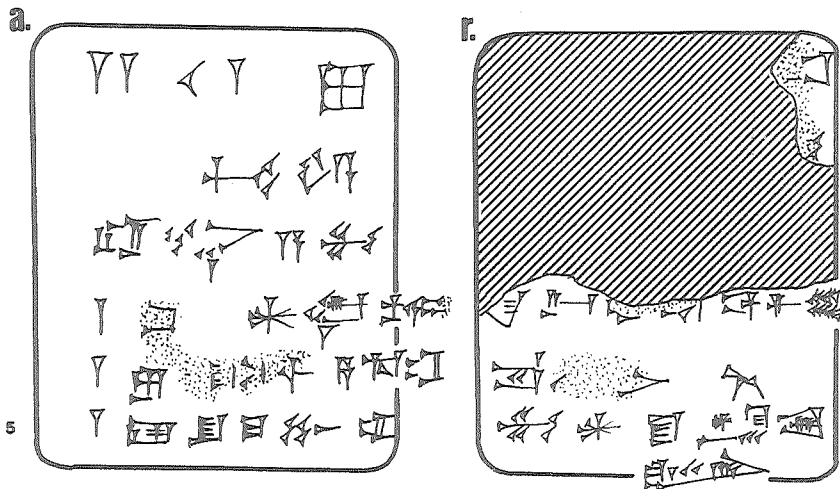

102 (MM 124)

AnOr 7 102
Drehem
ŠS2/v/8

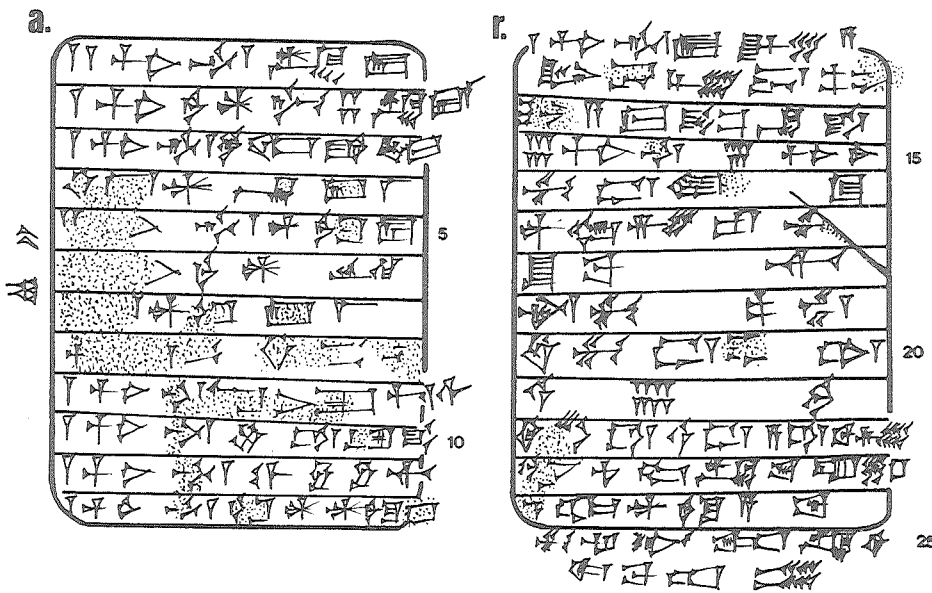

103 (MM 120)

AnOr 7 103
Drehem
ŠS2/viii/-

103. Sello:

Du₁₁-ga dub-sar
dumu Lu₂-^dNin-gir₂-su
sipa na-kab-tum

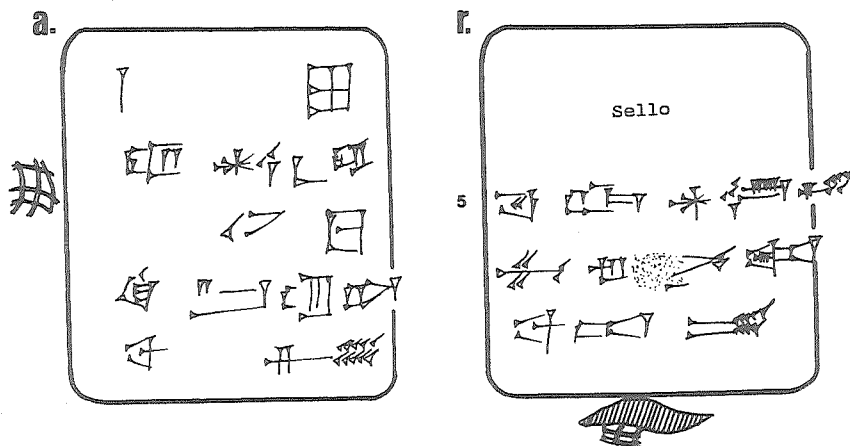

104 (MM 143)

AnOr 7 104
Drehem
SS8/x/16,17, 25

104. Sello:

[^dŠu]-^dSuen
lugal kal-ga
lugal Uri₃^{ki}-ma
lugal ^dUb-da limmu₂-ba
Ur-^dŠul-pa-[e₃]
dub-[sar]
dumu Ur-^d[Ha-ia₃]
[ar]ad₂-[zu]

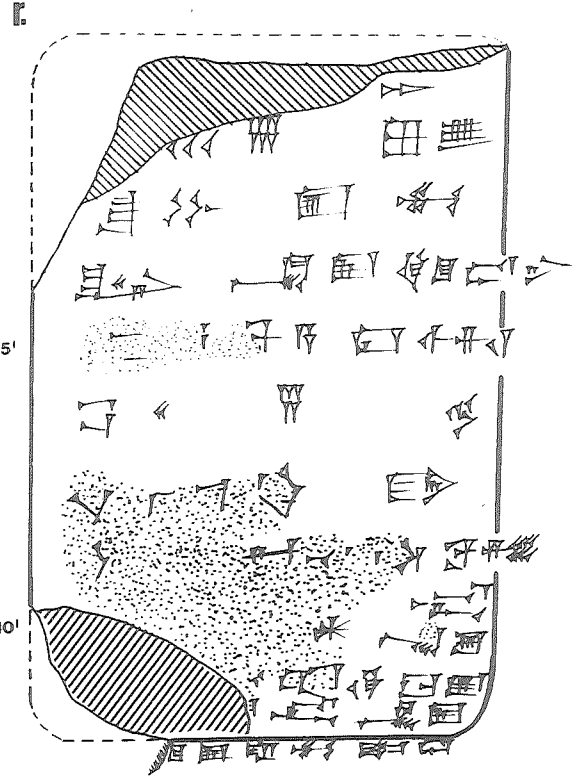
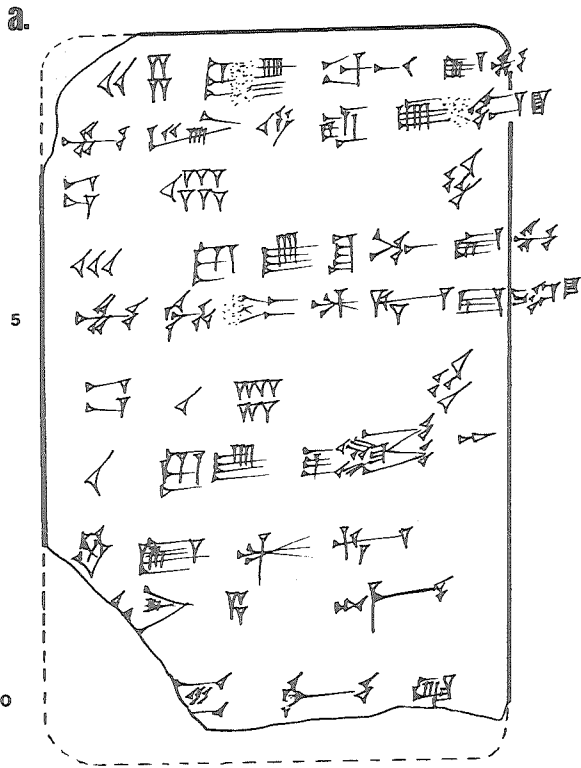

105 (MM 500)

AnOr 7 105
Drehem
ŠS9/-15

Perdido aprox. 1/3 de la tablilla

105. Sello:

i [^dŠu-^dSuen]
lugal-kal-ga
lugal Uri₃^{ki}-ma
lugal ^dUb-/da limmu₂-ba
ii [Hal-li₂-a]
du[b-sar]
dumu [Ad-da-a]
arad₂-[zu]

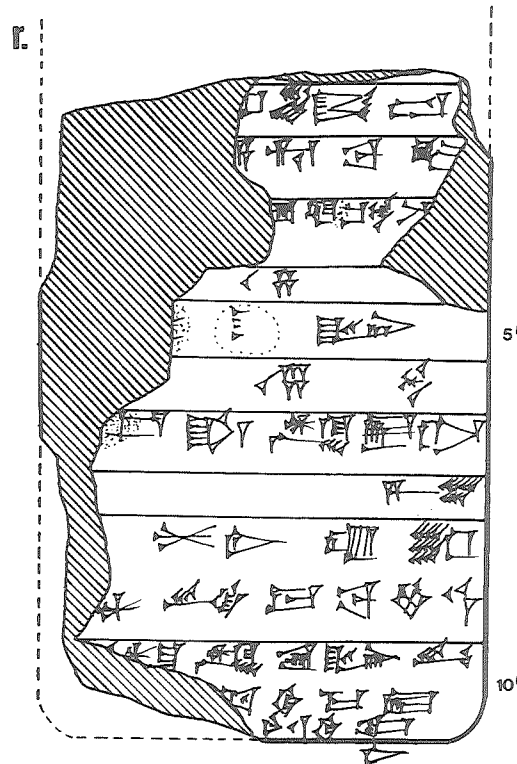
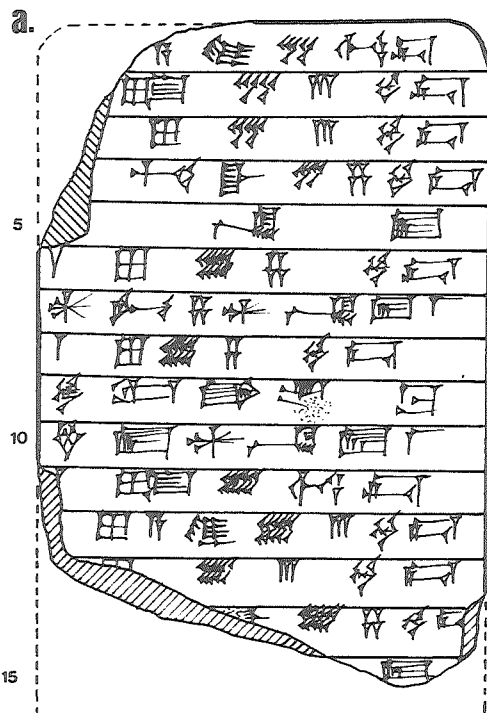

106 (MM 155)

AnOr 7 106
Drehem
ŠS9⁷/x/1

106. Sello:

- i ⁴Šu-⁴Suen
lugal kal-ga /lugal Uri,⁴/₂-ma
lugal ⁴Ub-/da limmu₂-ba
- ii Ur-k[u₂-nun-na]
dub-sar
dumu L[u₂-⁴Nin-gir₂-/su kurušda]
arad₂-zu

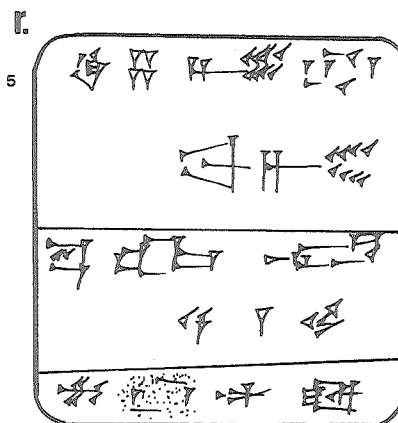
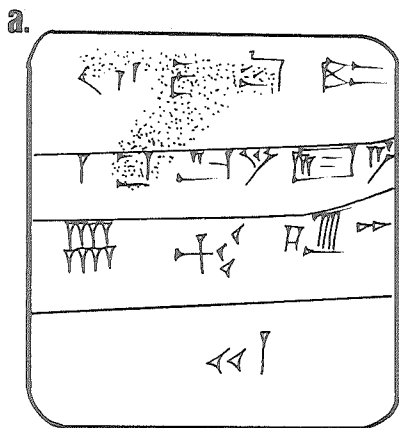

107 (MM 152)

AnOr 7 107
Drehem
ŠS9⁷/x/4

107. Sello:

- i ⁴Šu-⁴Suen
lugal kal-ga /lugal Uri,⁴/₂-ma
lugal ⁴Ub-da/ limmu₂-ba
- ii Ur-⁴Š[ul-pa]-/e₃
dub-sar
dumu Ur-⁴Ha-i[a₃]
arad₂-zu

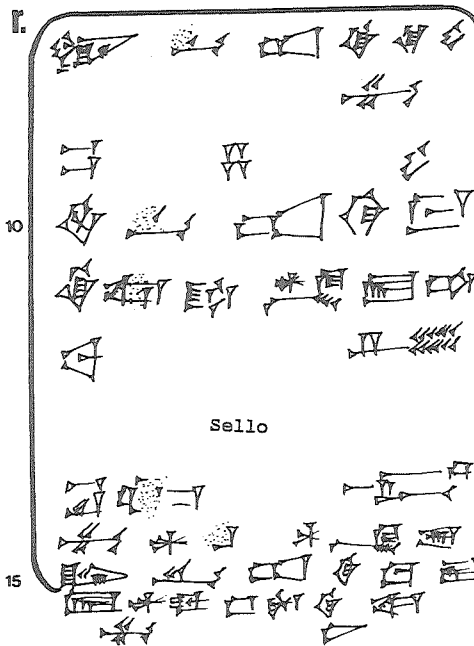
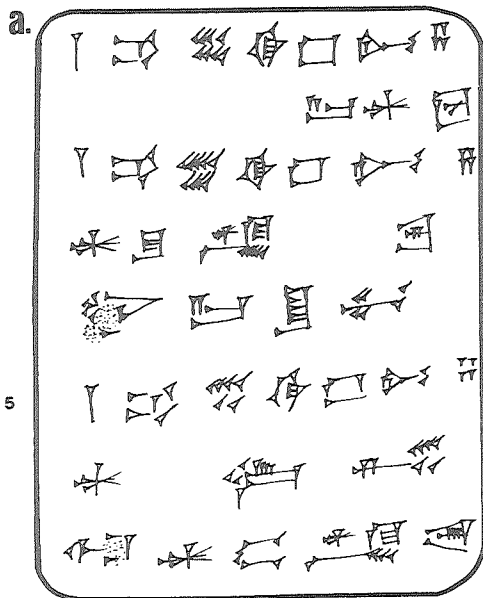

AnOr 7 108
Drehem
SS9/x/1-30

a.		i	ii	iii	iv
		田	田	田	田
		田	田	田	田
		田	田	田	田
5		田	田	田	田
		田	田	田	田
		田	田	田	田
10		田	田	田	田
		田	田	田	田
		田	田	田	田
		田	田	田	田
		田	田	田	田
15		田	田	田	田
		田	田	田	田
		田	田	田	田
		田	田	田	田
20		田	田	田	田
		田	田	田	田
		田	田	田	田
25		田	田	田	田
		田	田	田	田
		田	田	田	田

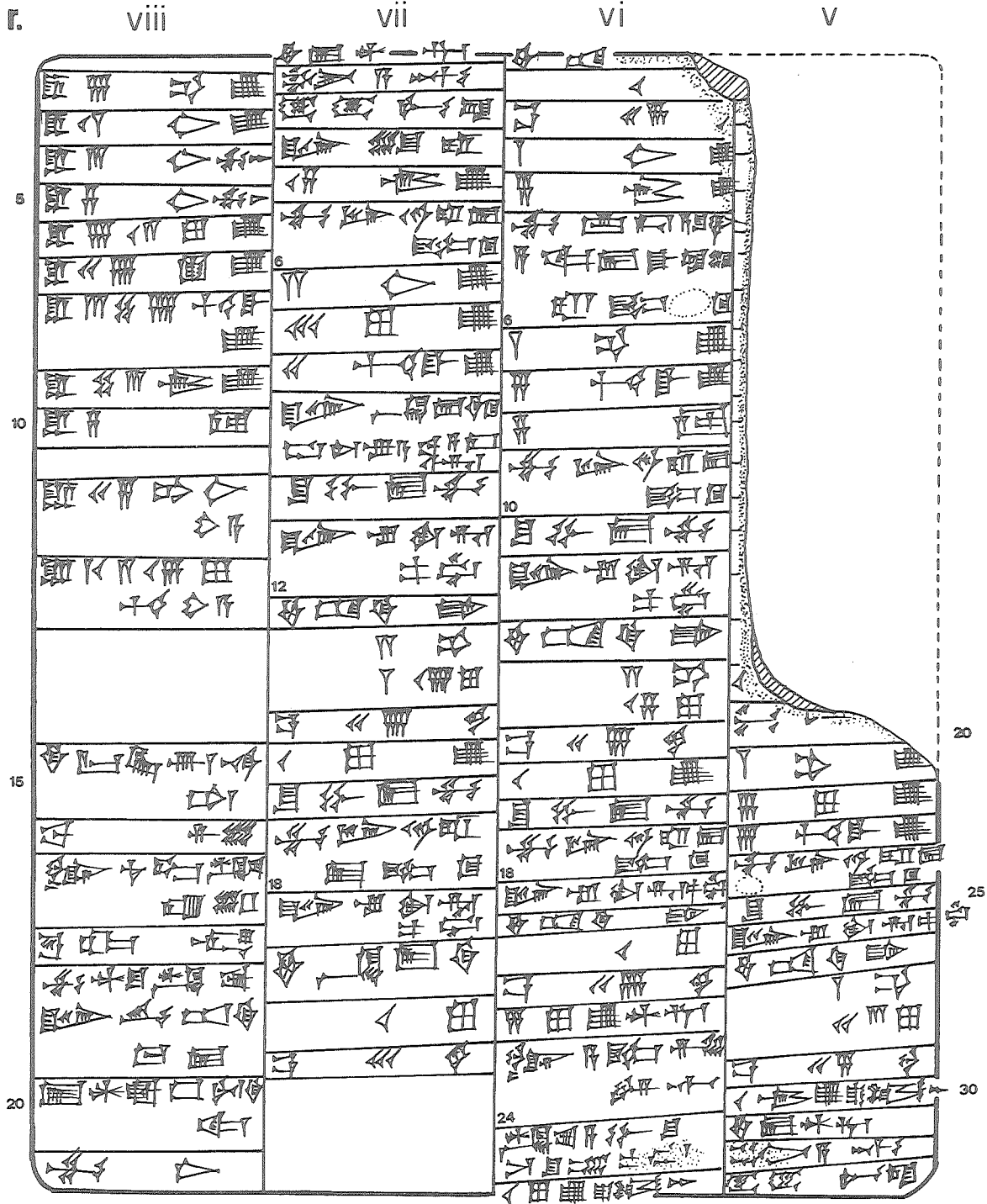

109 (MM 153)

AnOr 7 109
Drehem
ŠS9/xi/6,14

109. Sello:

- i ^aŠu-^aSuen
lugal kal-ga /lugal Uri,^{ai}-ma
lugal ^aUb-da/ limmu₂-ba
- ii Ur-^aŠ[ul-pa]-/r^e₃[~]
dub-sar
dumu Ur-^aHa-[ia,₃]
arad₂-zu

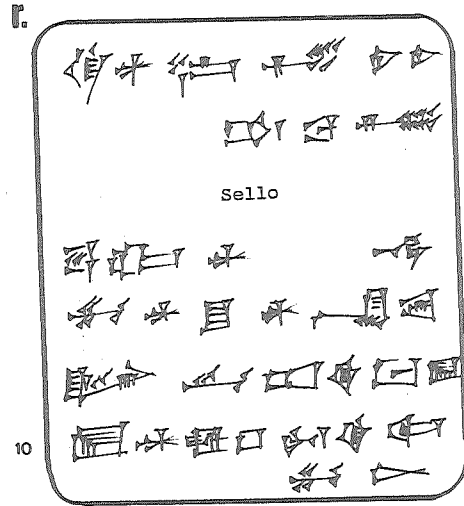
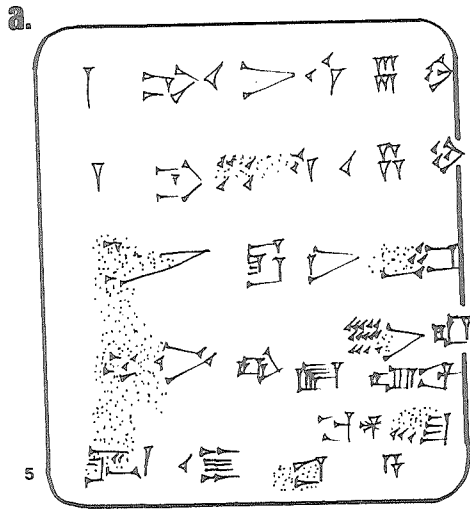

110 (MM 202)

AnOr 7 110
Drehem
[]/ []/18

110. Sello:

Nu-^rur₂-^a[Adad]
dumu Šu-^aAdad

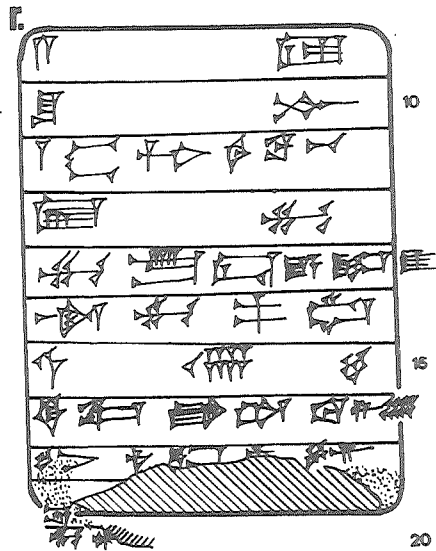
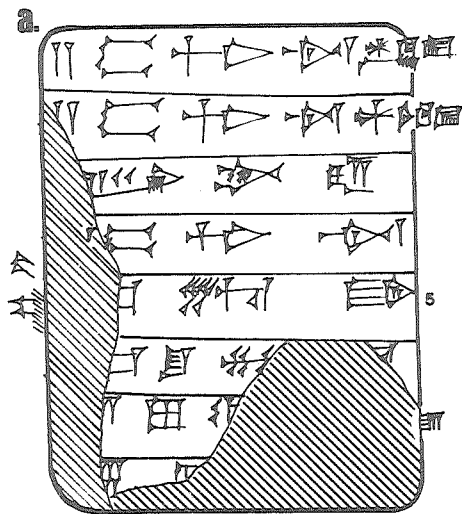

111 (MM 203)

AnOr 7 111
Drehem
[]

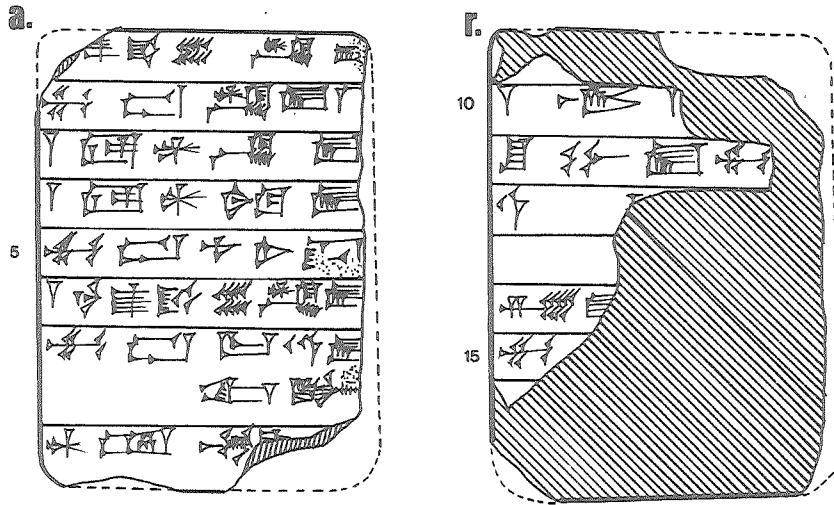

112 (MM 151)

AnOr 7 112
Lagaš?
ŠS9/v/-

112. Sello:

- i ⁴Šu-⁴Suen
lugal kal-ga
lugal Uri,⁴ma
lugal ⁴Ub-/da limmu₂-ba
- ii Ur-[ku₃-nun-na]
dub-[sa]r
dumu Lu₂-[⁴Nin-gir₂-/su kurušda]
[arad₂-zu]

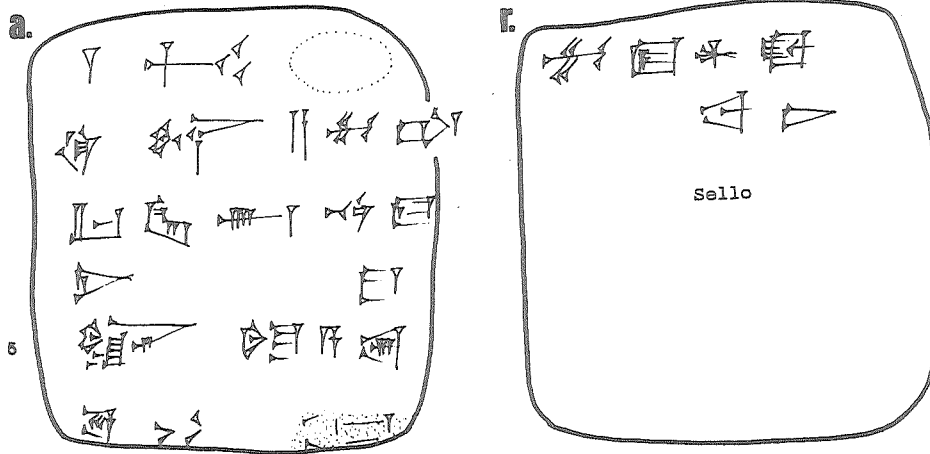

113 (MM 217)

AnOr 7 113
Drehem
AS4 6 9/xi/9

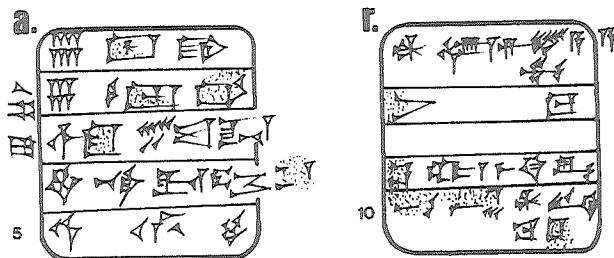

114 (MM 26)

AnOr 7 114
 Drehem
 Š35/- (vi-viii)

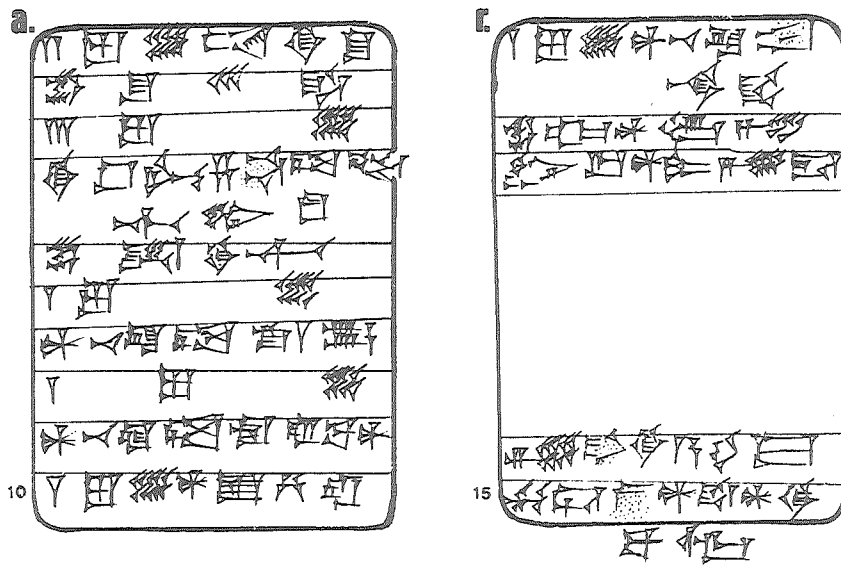

115 (MM 35)

AnOr 7 115
 Drehem
 Š36/v vii 6 ix/-

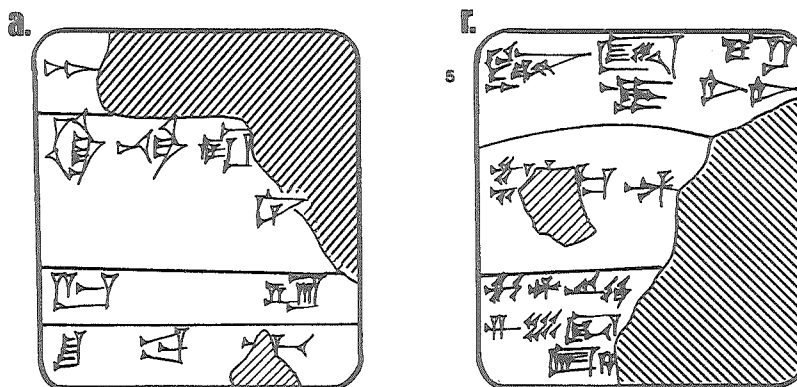

116 (MM 446)

AnOr 7 116
 Umma
 Š36/vi/-

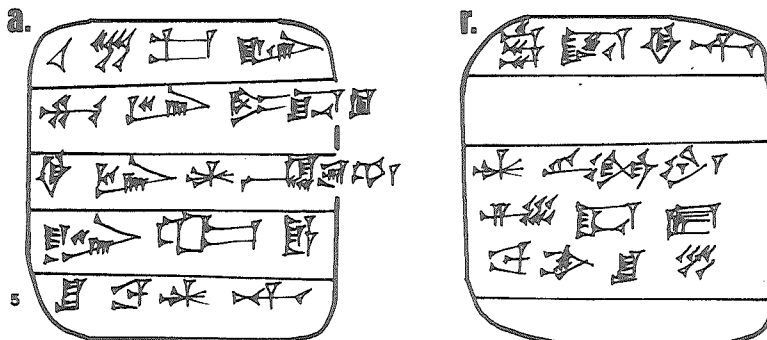

117 (MM 460)

AnOr 7 117
Drehem
Š44/vi/20

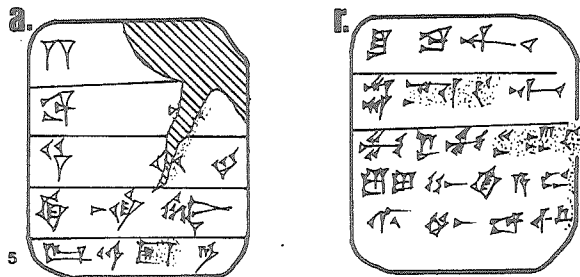

118 (MM 455)

AnOr 7 118
Drehem
Š44/x/8

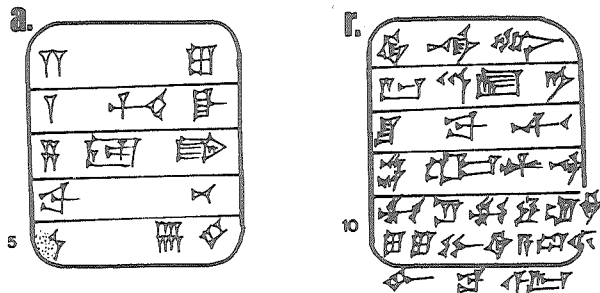

119 (MM 451)

AnOr 7 119
Drehem
Š47/iv ó v/26

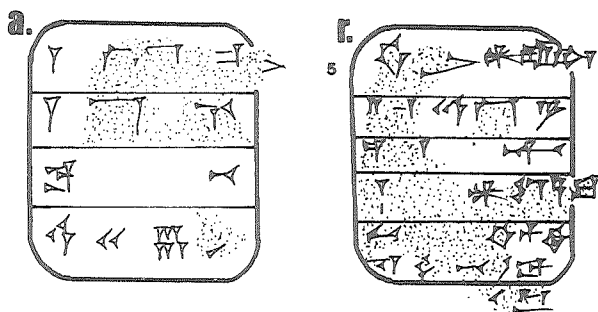

120 (MM 218)

AnOr 7 120
Drehem
ŠS4/ii/20

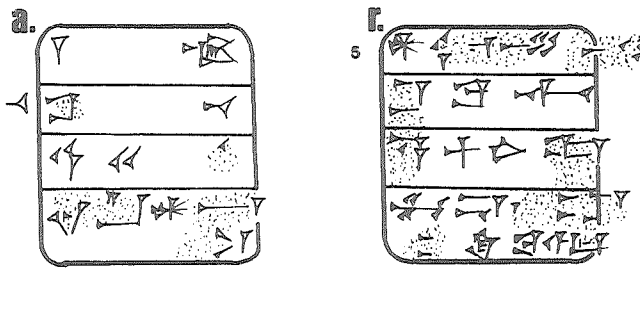

121 (MM 457)

AnOr 7 121
Drehem
Š47/i/2 ó 3

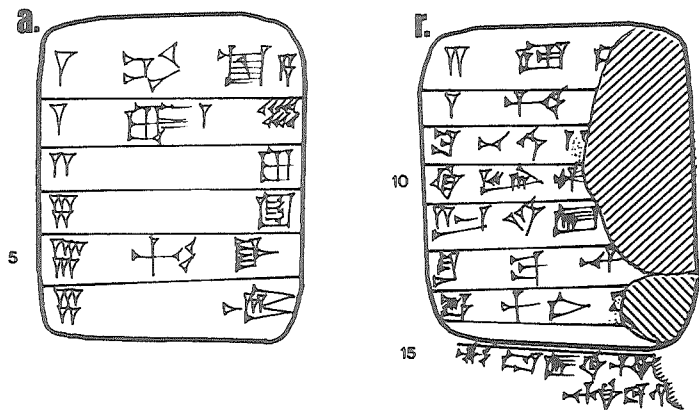

123 (MM 458)

AnOr 7 123
Drehem
Š47/vii/11

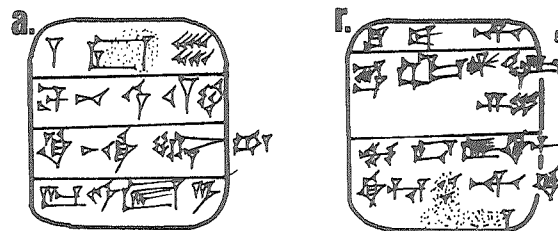

122 (MM 94)

AnOr 7 122
Drehem
Š47/iv/-

Tablilla

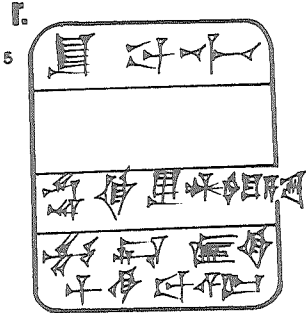
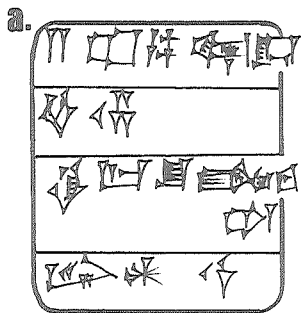

122. Sello:

Lu₂-^dUtu
dumu Ma-an-^rsum^r

Envoltorio

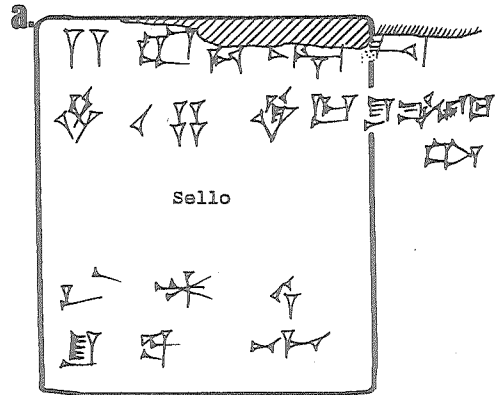

124 (MM 564)

AnOr 7 124
Drehem
Š48/iii/-

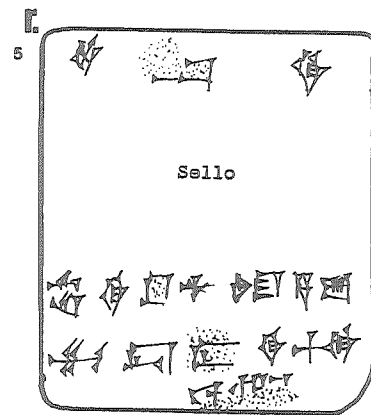
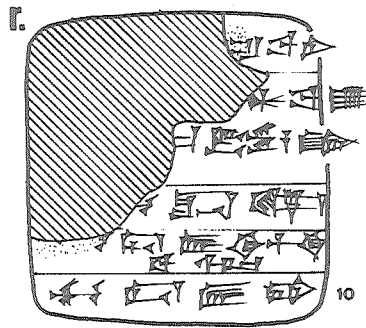
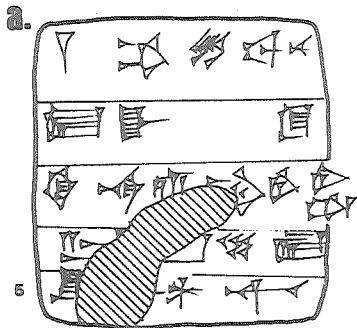

125 (MM 206b)

AnOr 7 125
Umma
AS1/-

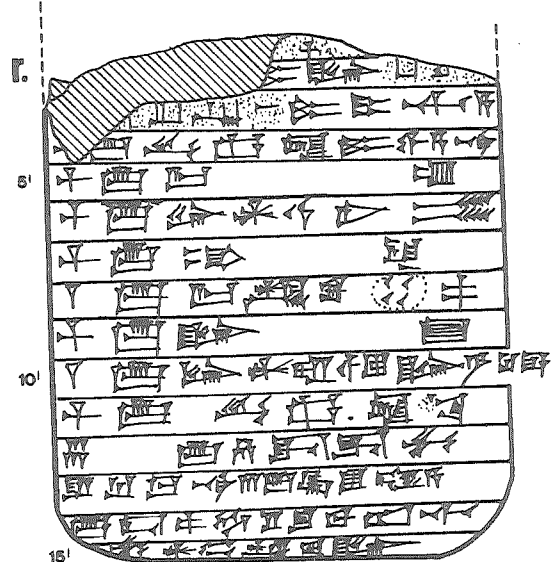
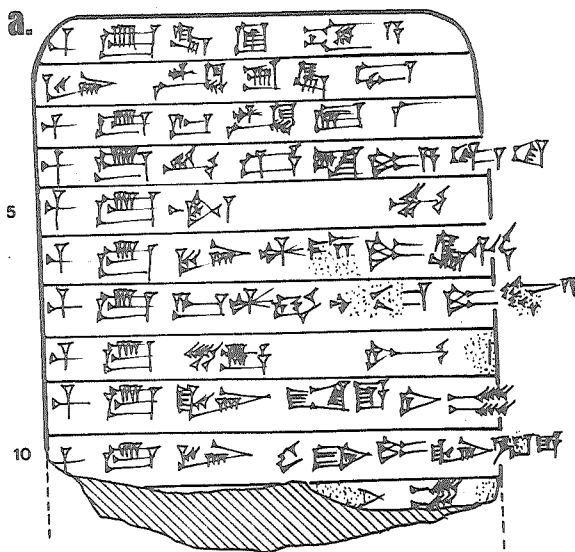

126 (MM 436)

AnOr 7 126
Drehem
AS2/iii/6

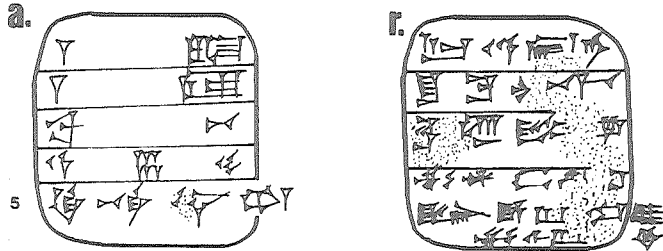

127 (MM 109)

AnOr 7 127
Drehem
Š42 ó AS6/i-xii/-

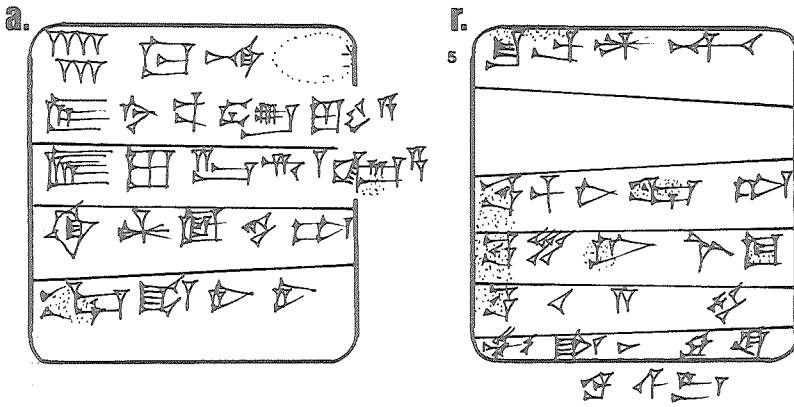

128 (MM 102)

AnOr 7 128
Drehem
AS4/viii/-

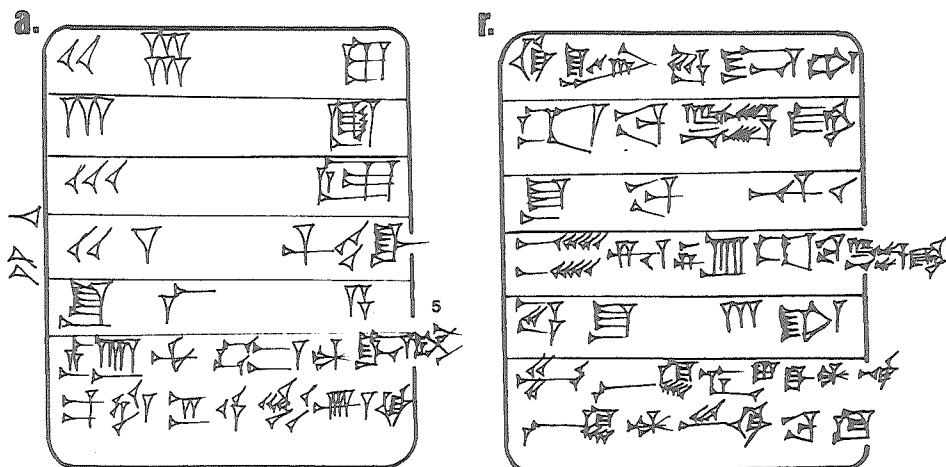

129 (MM 165)

AnOr 7 129
Drehem
AS5/-

129. Sello:

- i ^dŠul-gi
nita kal-ga
lugal Uri₂/^{ba}-ma
- ii Na-^rša₆^r
kuruš[da]
arad₂-zu

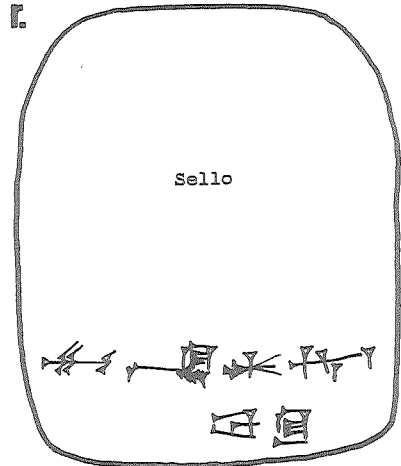
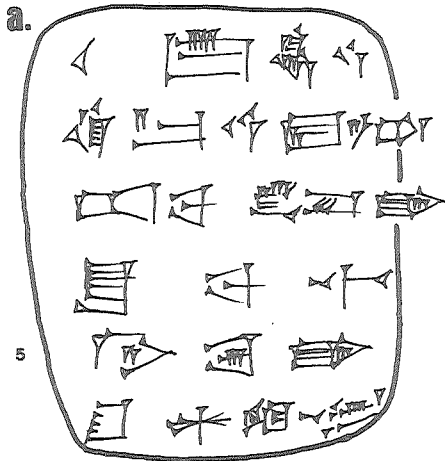

130 (MM 108)

AnOr 7 130
Drehem
AS6/x/-

130. Sello:

- i [^d]Amar-^dSuen
kal-ga
[lugal Uri₂/^{ba}-ma]
[lugal] ^dUb-/da limmu₂-ba
- ii Ur₂-^rra^r-[...]
x [...]
MU [...]
[arad₂-zu]

Tablilla

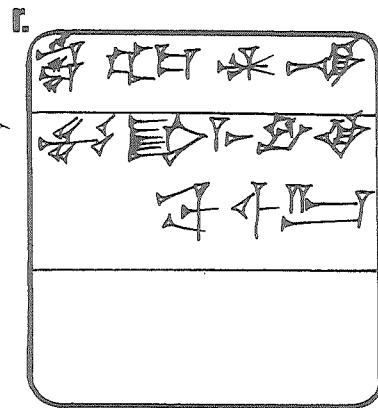
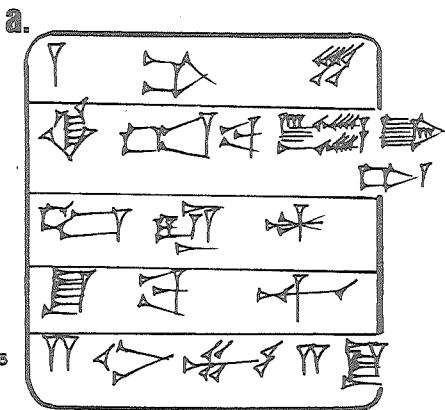

Envoltorio

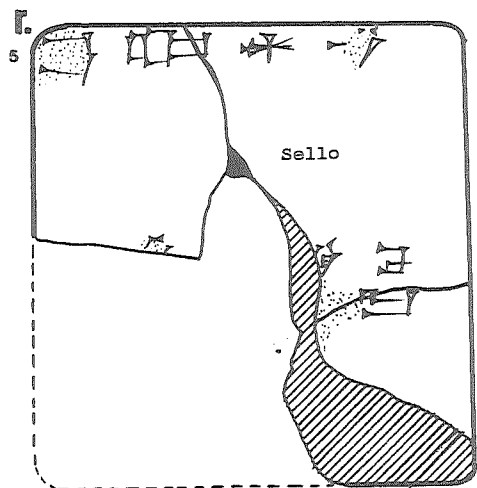
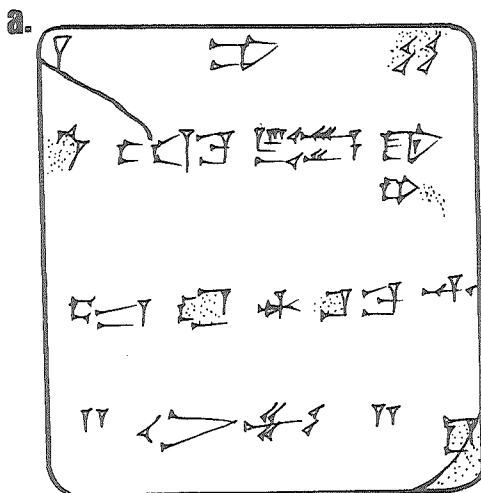

131 (MM 212)

AnOr 7 131
Drehem
AS6/xi/10

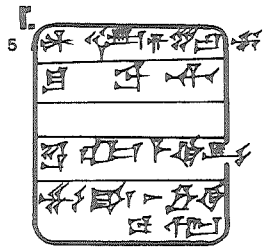
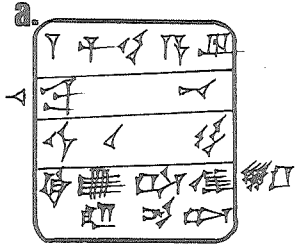

133 (MM 214)

AnOr 7 133
Drehem
AS7/i/22

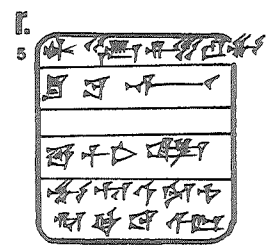
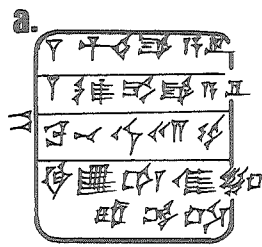

132 (MM 110)

AnOr 7 132
Drehem
AS6-7/-/-

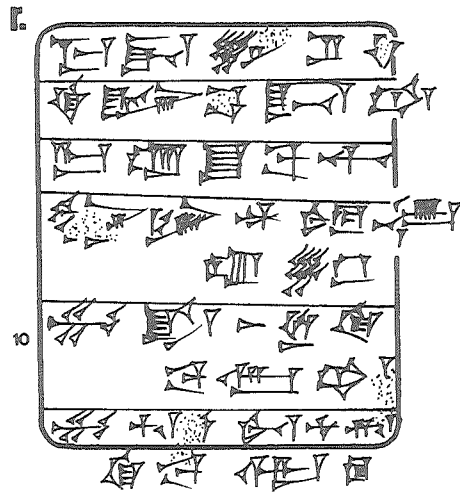
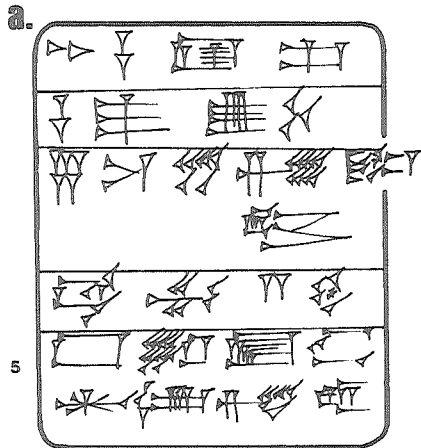

134 (MM 459)

AnOr 7 134
Drehem
AS7/v/10[(±x)]

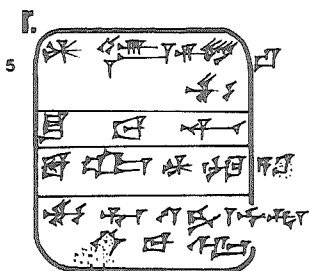
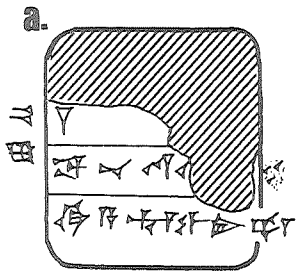

135 (MM 113)

AnOr 7 135
Drehem
AS8/vii/-

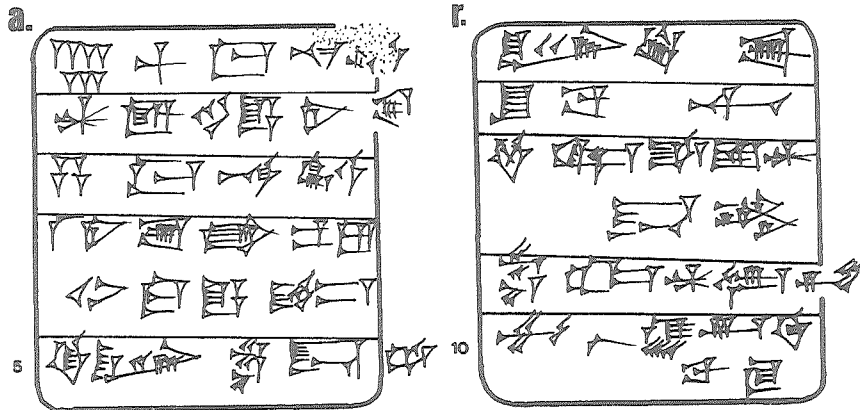

136 (MM 211)

AnOr 7 136
Drehem
AS8/vii/26

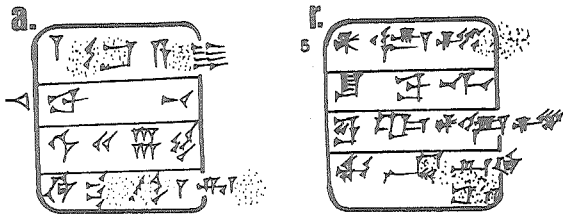

137 (MM 445)

AnOr 7 137
Drehem
AS8/xi/12

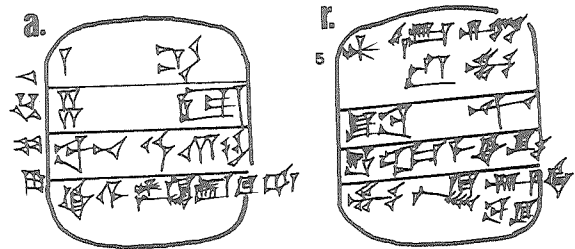

138 (MM 452)

AnOr 7 138
Drehem
ŠS2/ix/15

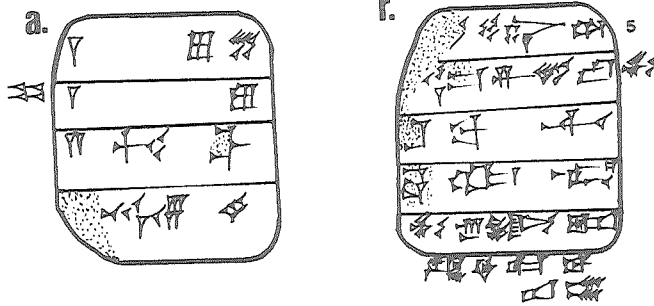

139 (MM 448)

AnOr 7 139
Drehem
AS2/xi/1

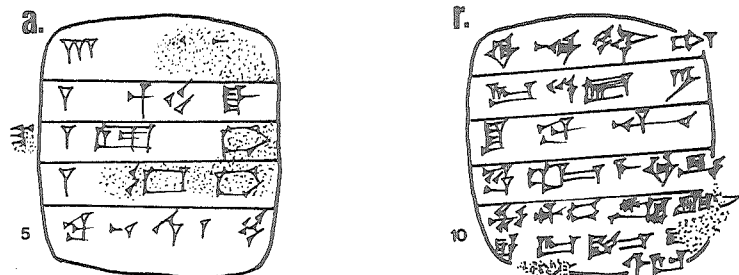

140 (MM 177)

AnOr 7 140
Drehem
ŠS8/v/-

140. Sello 1:

A₂-pil-lum
dumu A-hu-tâb
[arad₂ ʔŠa[raʔ]

Sello 2:

Lu₂-^dSuen
dumu Ur-ša₆-g[a]
mu₆-sub₃ [...]

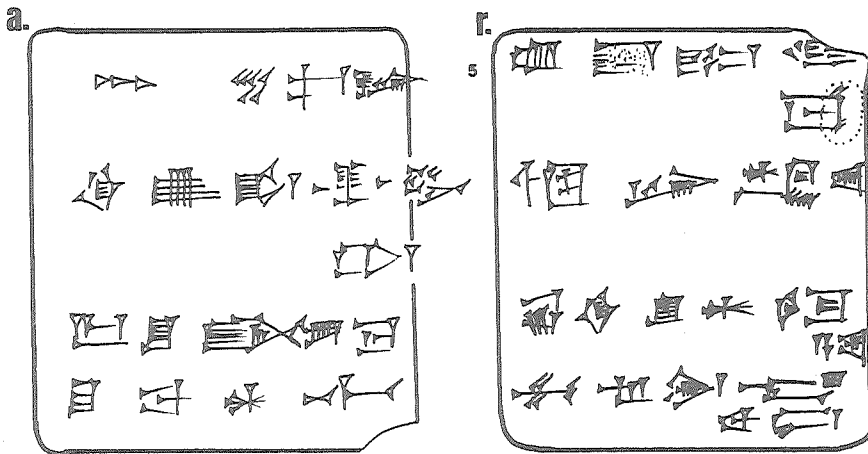

141 (MM 163)

AnOr 7 141
Drehem
IS1/xi/-

141. Sello:

Du₁₁-ga dub-[sar]
dumu Lu₂-[^dNin-gir₇-su]
sipa na-kab-[tum]

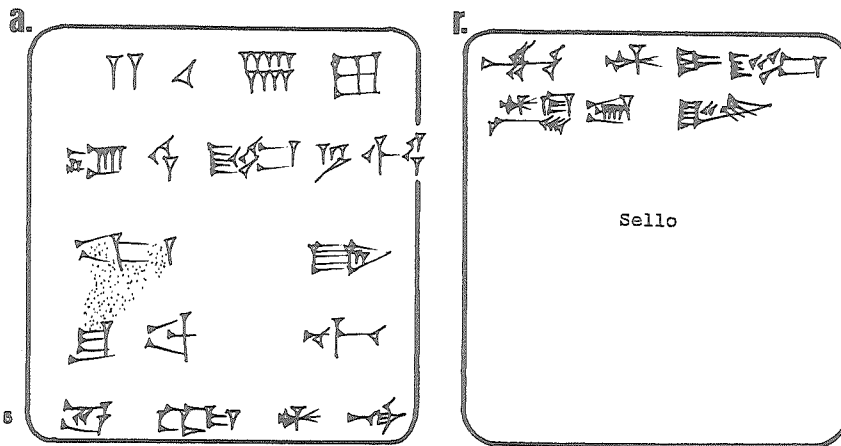

142 (MM 216)

AnOr 7 142
Drehem
[]/ii ó iii/13

143 (MM 444)

AnOr 7 143
Drehem
AS7/iii/4

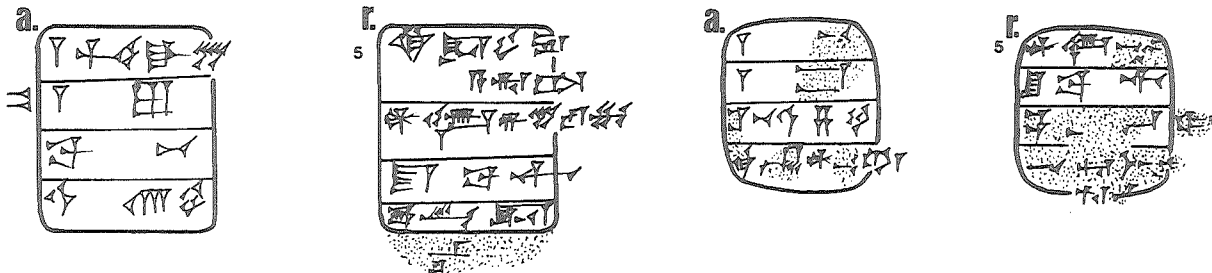

144 (MM 54+1101)

AnOr 7 144 (MM 54)
 Drehem
 Š43/xii/-

144. Sello:

Be-li₂-tâb kurušda
 Šul-gi-/ <si₂>-im-tum-ma

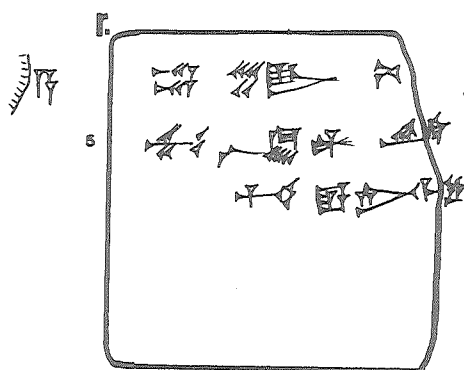
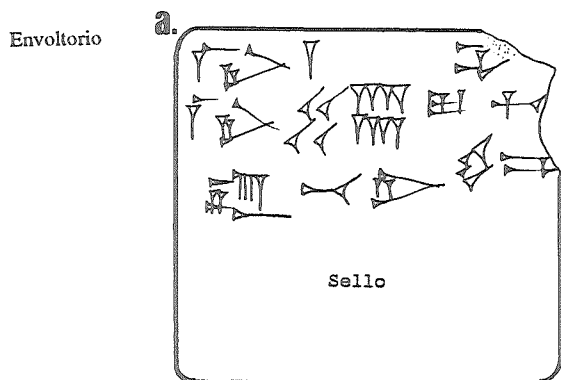
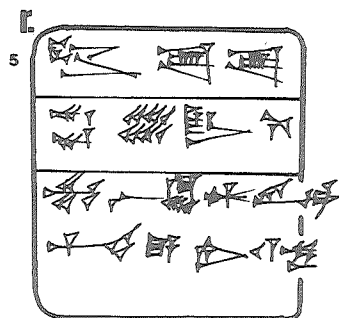
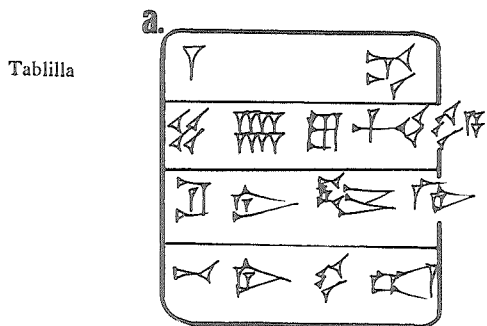

145 (MM 88)

AnOr 7 145
 Drehem
 Š47/xi/-

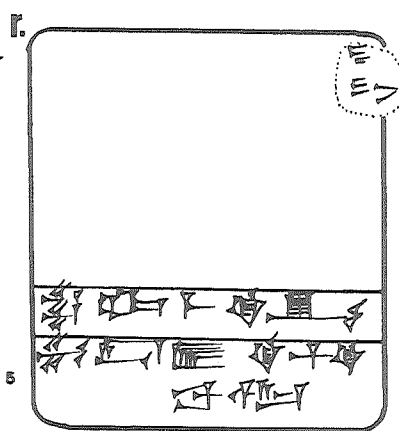
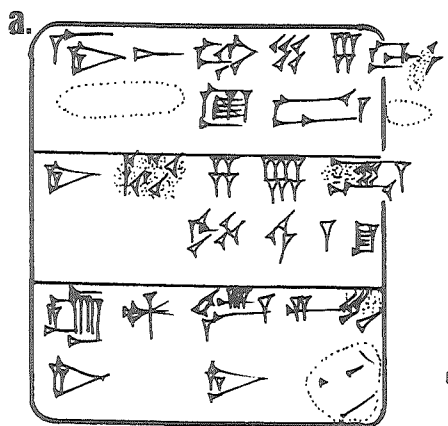

146 (MM 555)

AnOr 7 146
Umma
AS9/viii/-

146. Sello:

Lugal-iti-da
nu-banda₃ [gu₄]
[dumu Giri₃-ne₂]

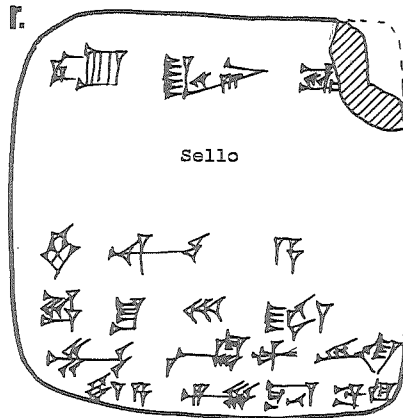
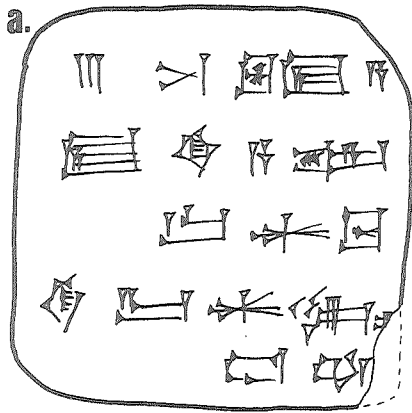

147 (MM 27)

AnOr 7 147
Drehem
Š34/v/-

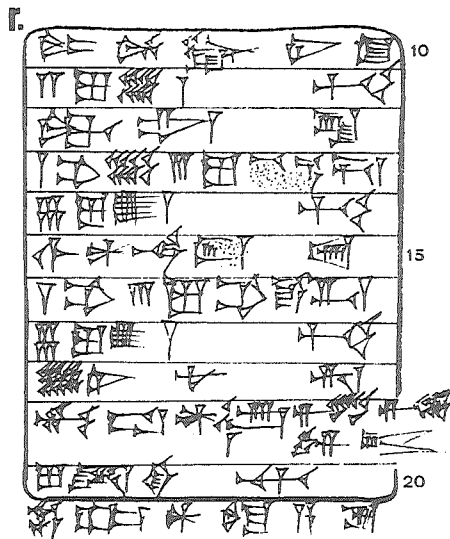
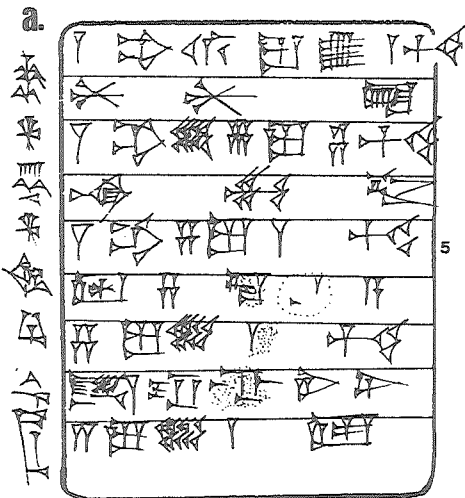

148 (MM 59)

AnOr 7 148
Drehem
Š44/viii/17

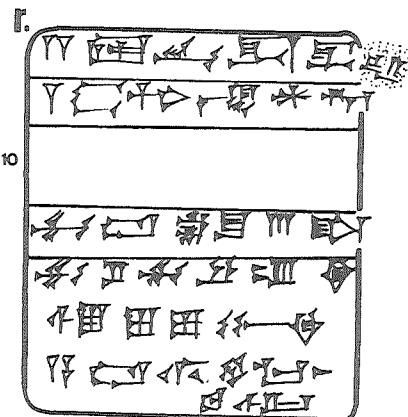
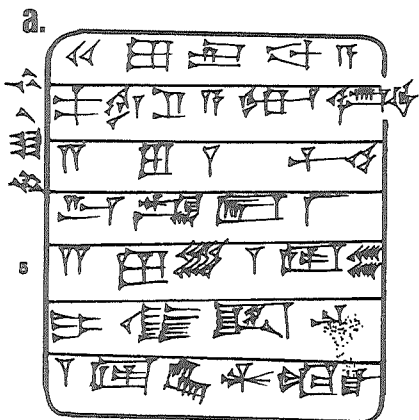

149 (MM 57)

AnOr 7 149
Drehem
Š44/viii/-

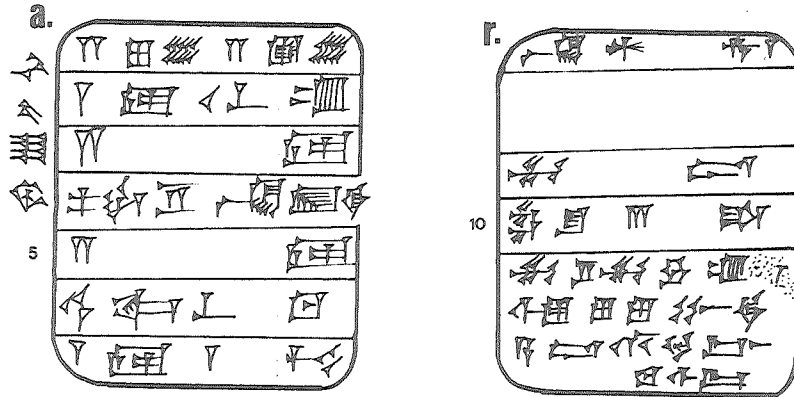

150 (MM 93)

AnOr 7 150
Drehem
Š47/vi/20

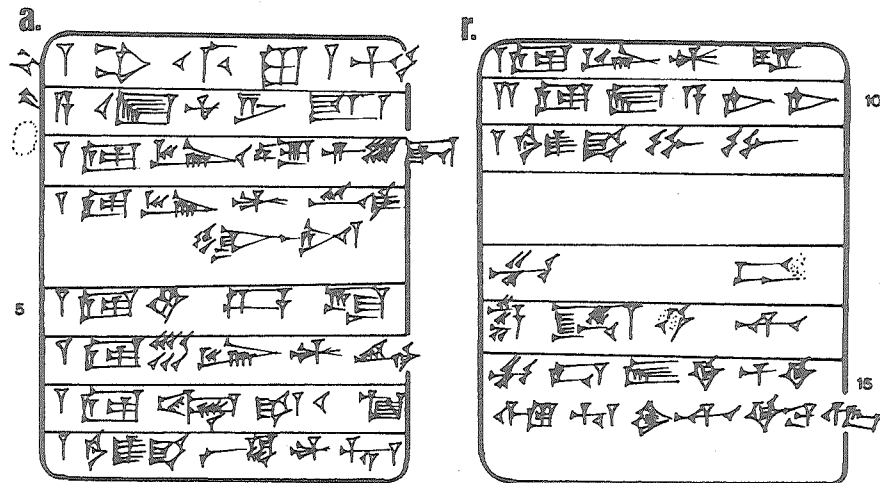

151 (MM 73)

AnOr 7 151
Drehem
Š46/xi/21

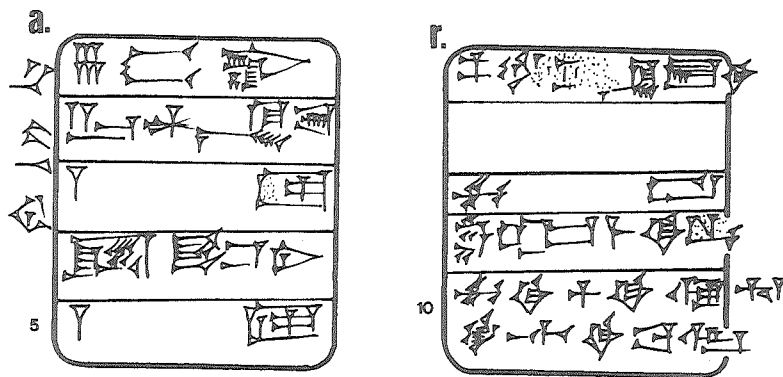

152 (MM 86)

AnOr 7 152
Drehem
Š47/viii/-

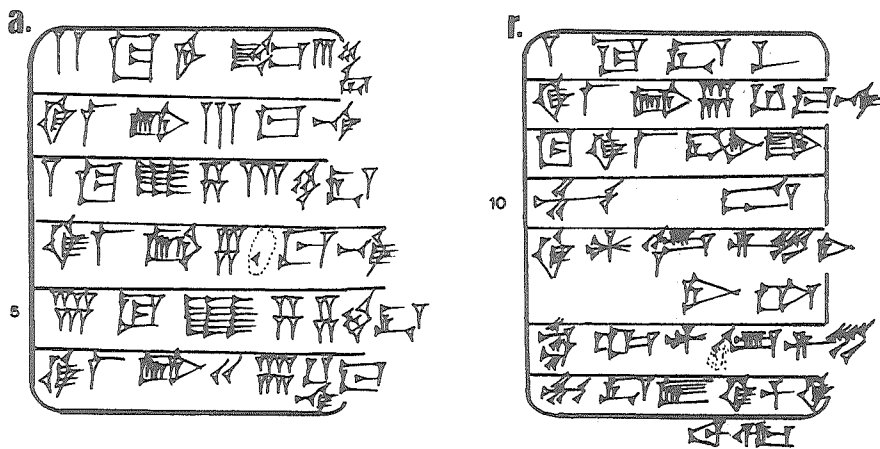

153 (MM 41)

AnOr 7 153
Drehem
Š38/x/-

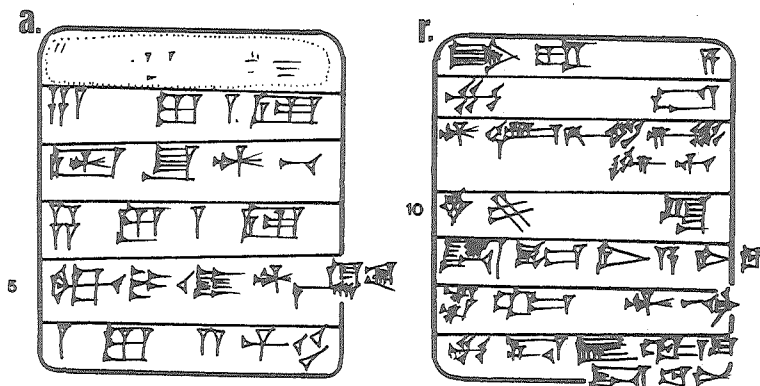

155 (MM 69)

AnOr 7 155
Drehem
Š45 6 AS2/x/-

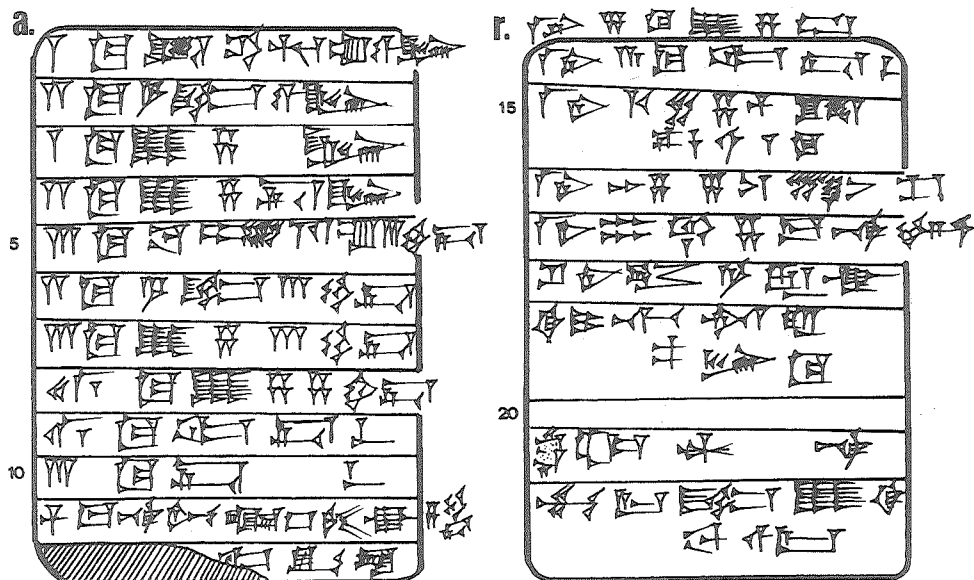

AnOr 7 154
Drehem
AS9/- {AS8/xii}

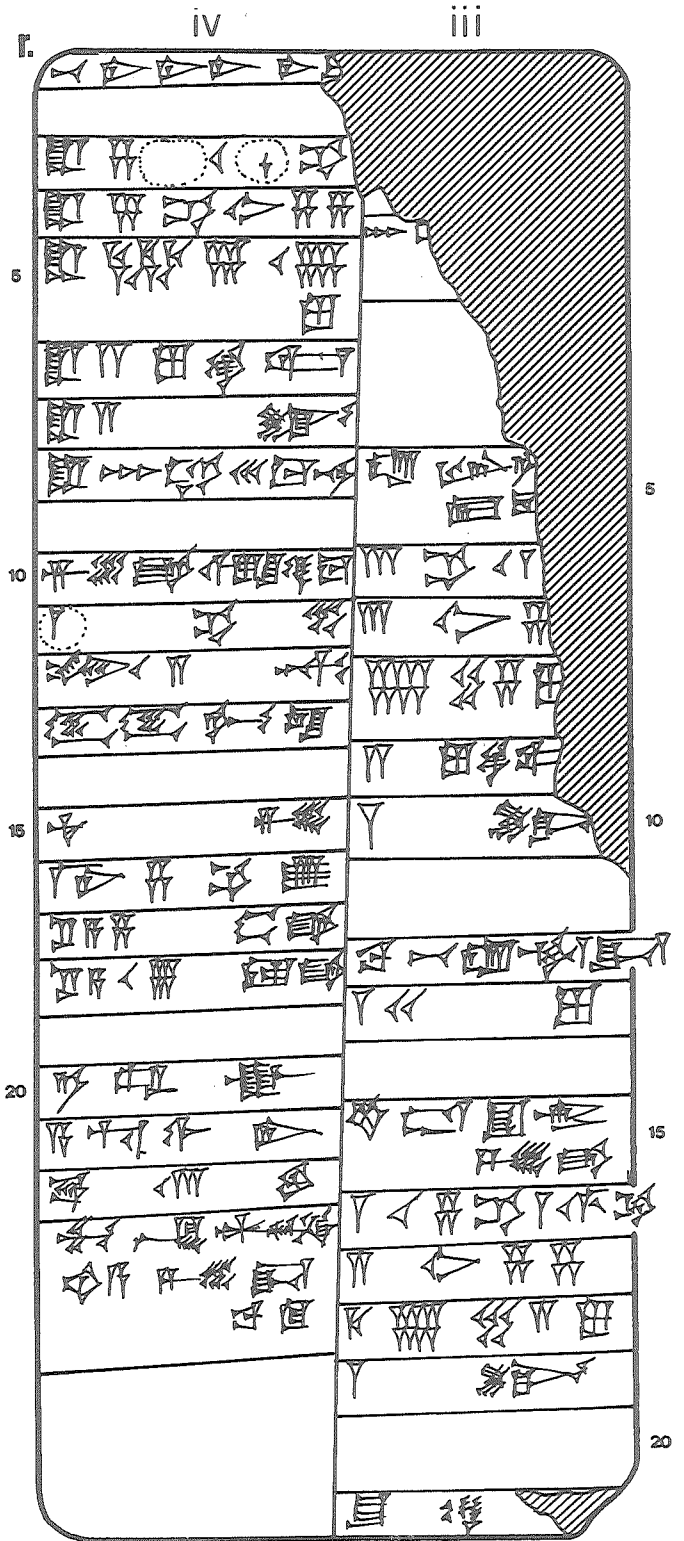
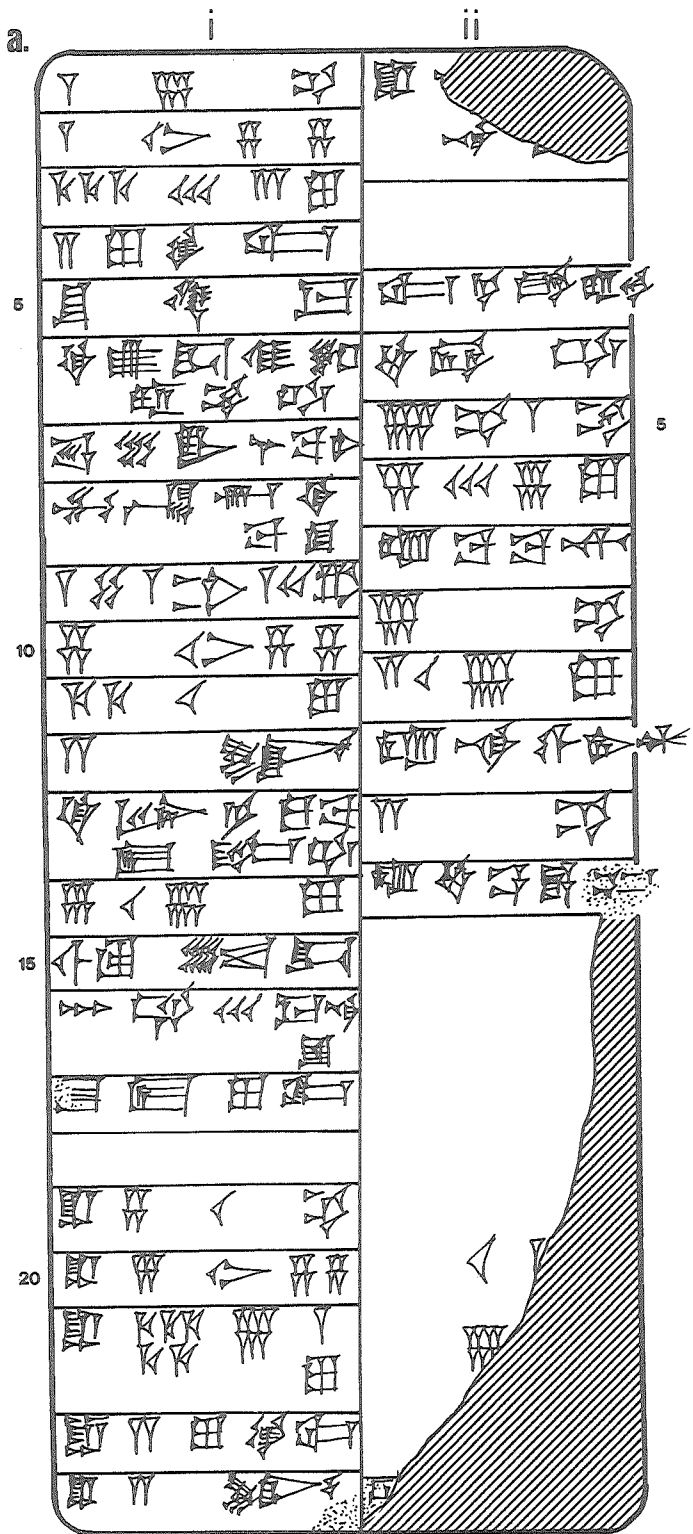

156 (MM 193)

AnOr 7 156
Umma?
AS4 5 8 9 6 IS4/[]

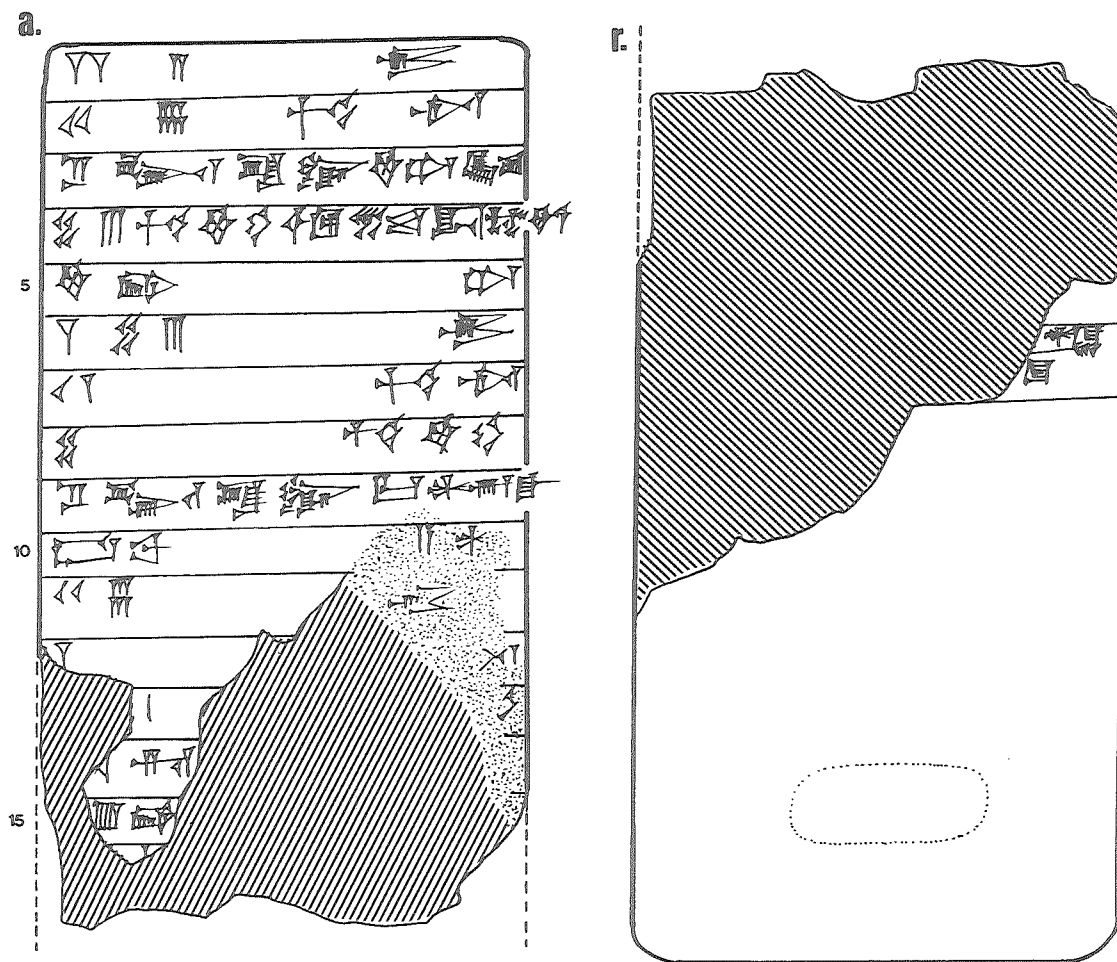

157 (MM 205)

AnOr 7 157
Drehem?
-vii/-

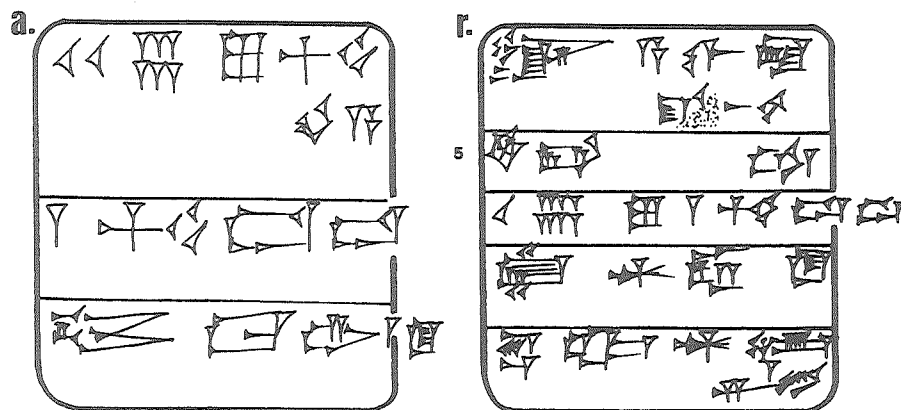

158 (MM 60)

AnOr 7 158
Drehem
Š44/x/-

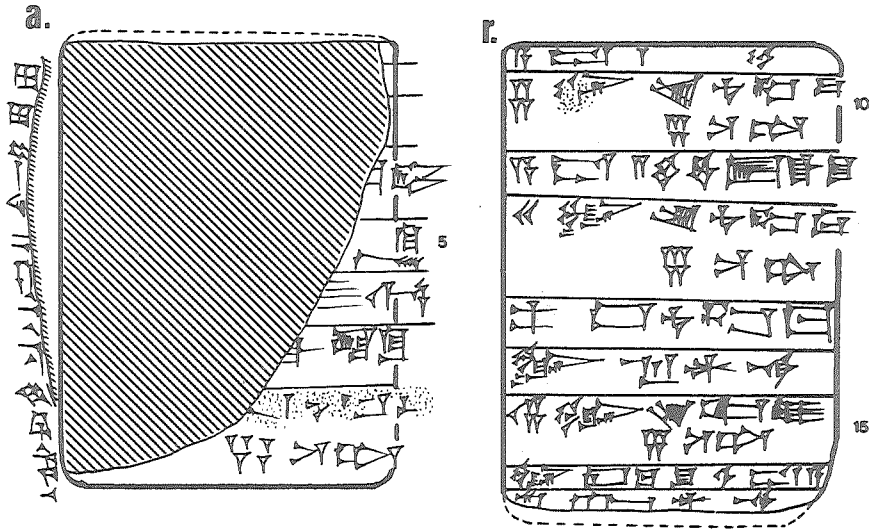

159 (MM 148)

AnOr 7 159
Drehem
ŠS9/xii/[]

159. Sello:

- i Šu-^dSuen
lugal kal-ga /lugal Uri,^{ki}-ma
lugal ^dUb-/da limmu,-ba
- ii Nu-ur,^dSuen
dub-sar
dumu I-ti-/Er,^{ra}-
arad,-zu

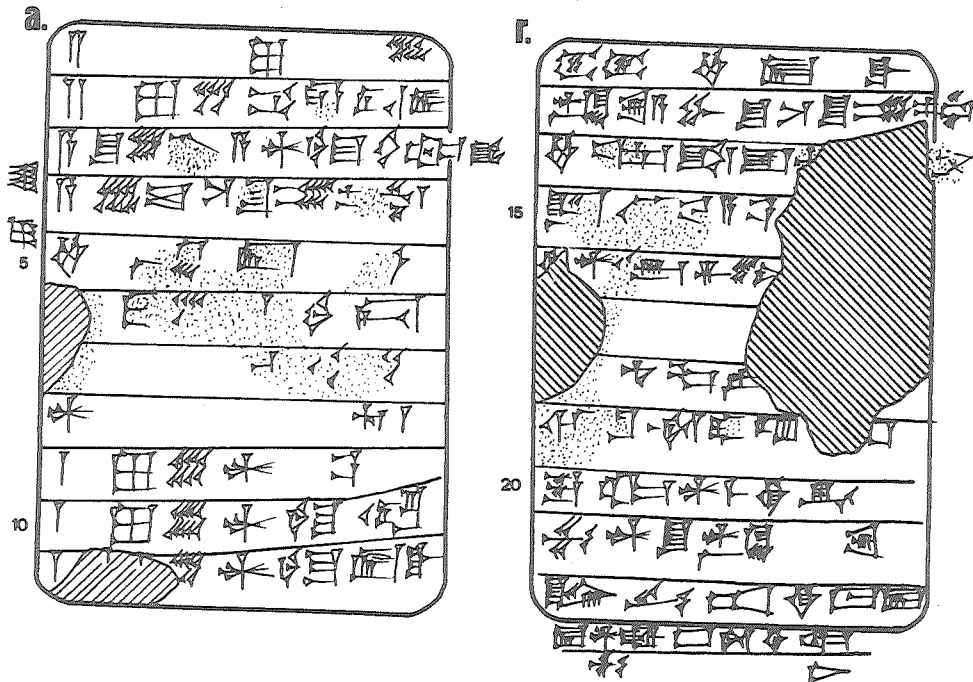

160. Sello:

- i [Šu⁴Suen]
- lugal-kal-ga
- lugal Uri³/⁴ma
- lugal Ub-/da limmu₂-ba
- ii [Hal-l₂-a]
- dub-sar
- dumu Ad-da-a
- arad₂-zu

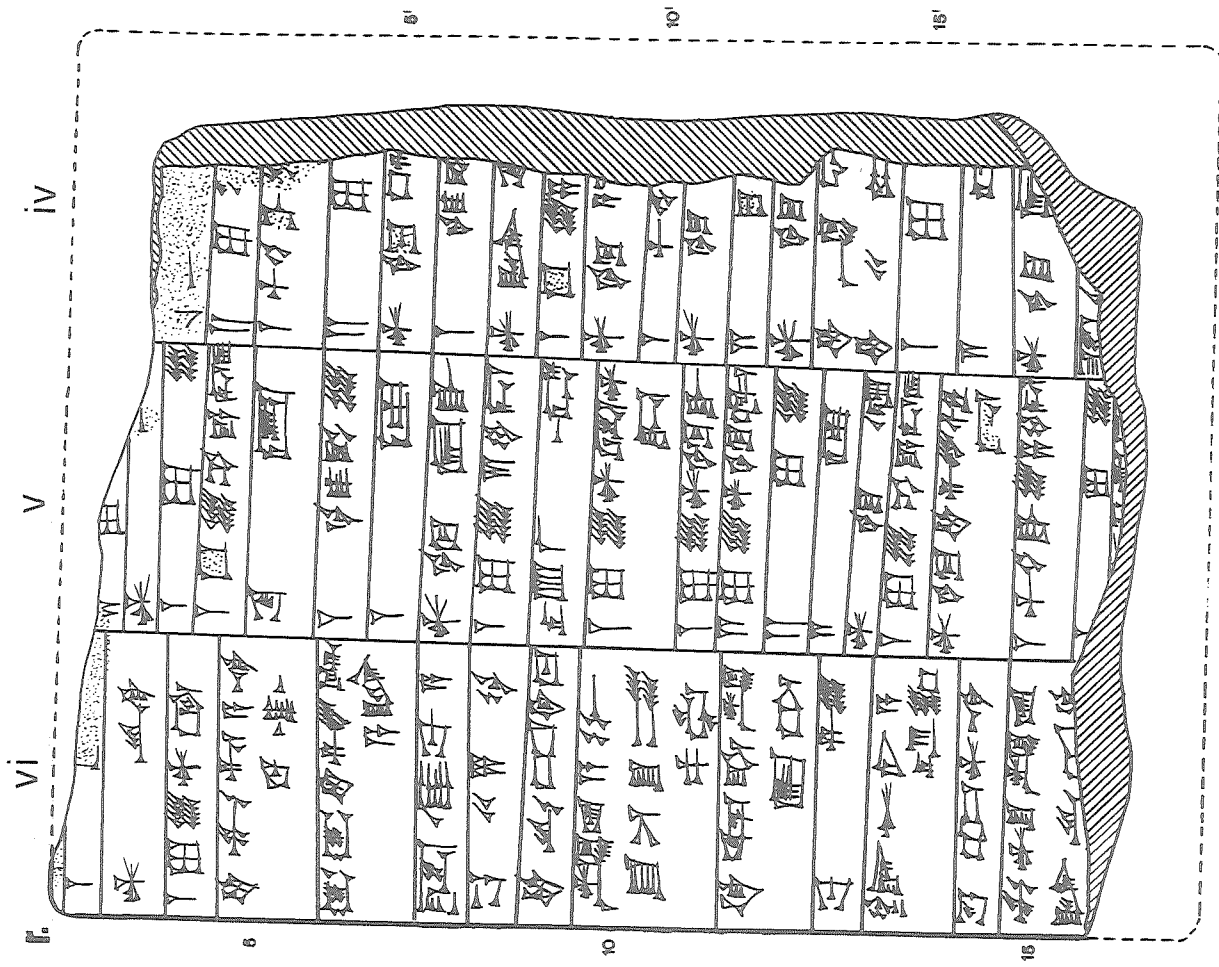

160 (MM 159)

AnOr 7 160
 Drehem
 ŠS.../x 6 xi/1 ~25

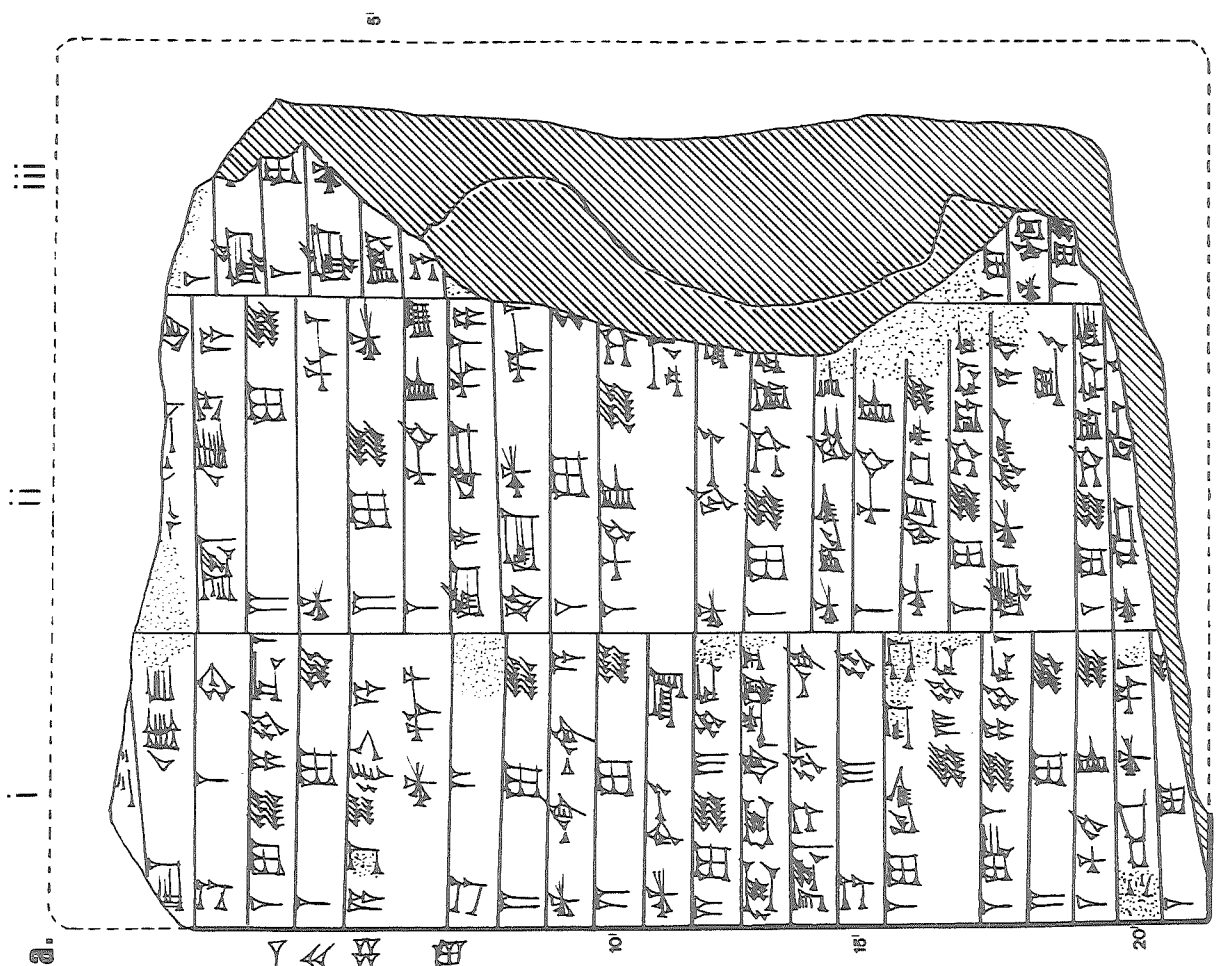

161 (MM 192)

AnOr 7 161
Drehem
AS9/[]

161. Sello:

Nu-ur₂-⁴Suen
dub-sar
dumu I-[ti-Er₃-ra]

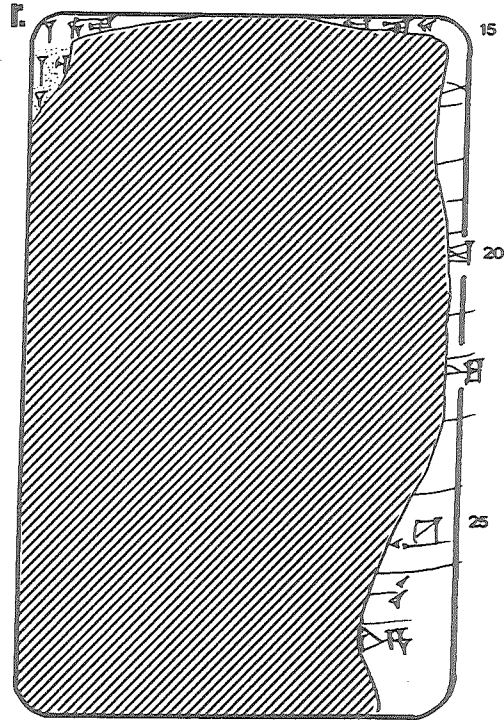
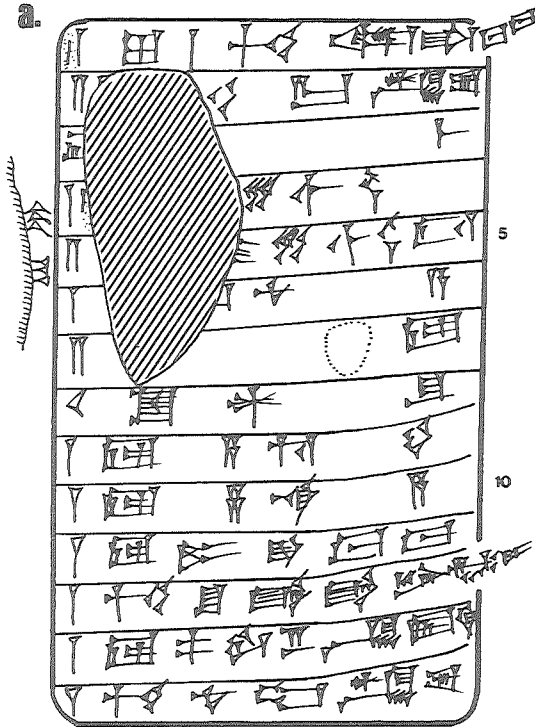

162 (MM 422)

AnOr 7 162
Drehem
Š42 6 AS6/x/18

Perdida aprox. media tablilla

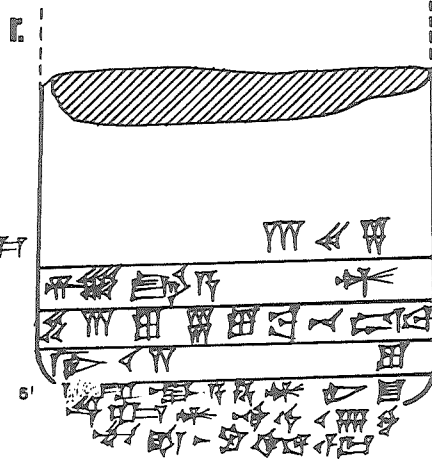
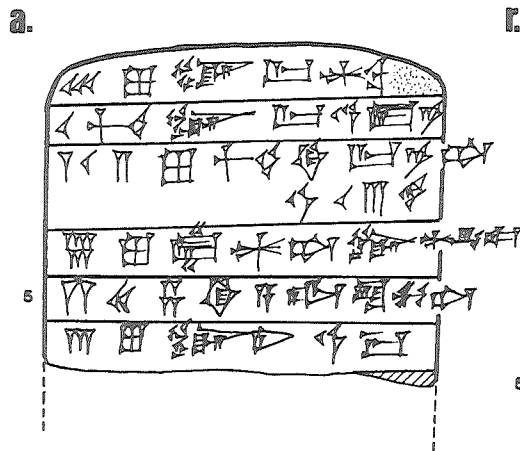

163 (MM 540)

AnOr 7 163
Umma
[]

Anverso anepigráfico con borradura sobre antiguas líneas en sentido transversal a las del reverso

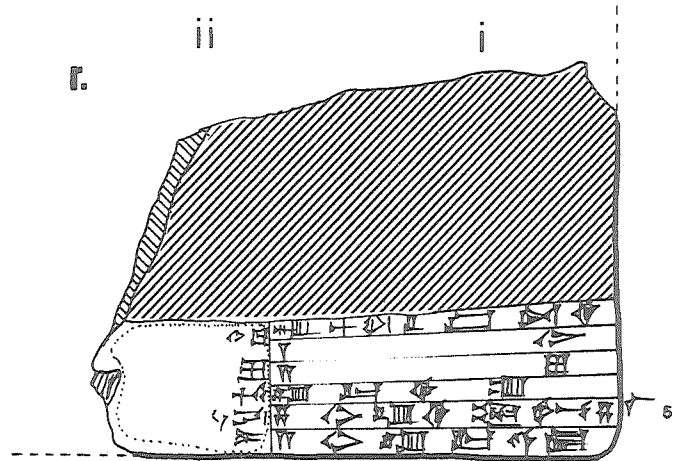

164 (MM 543)

AnOr 7 164
Umma
[]

164. Sello:

Lu₂-kal-la
dub-sar
dumu Ur-e₁₁-e kuš,

Reverso destruido

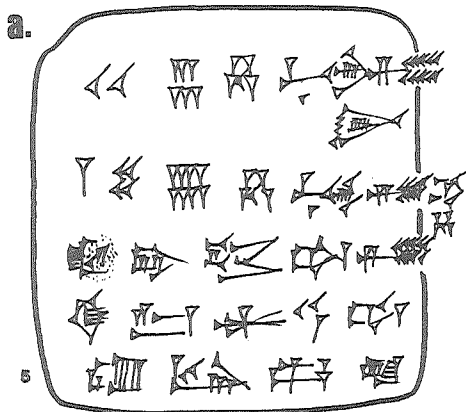

165 (MM 527)

AnOr 7 165
Drehem
[]

Reverso destruido

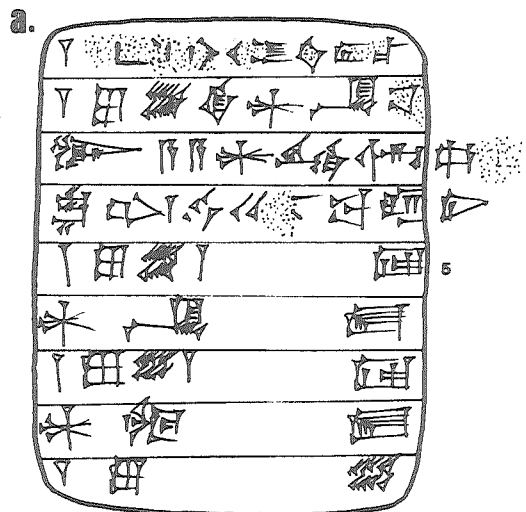

166 (MM 115)

AnOr 7 166
Drehem
-/- {AS9/viii, ŠS1/viii, ŠS2/iv}

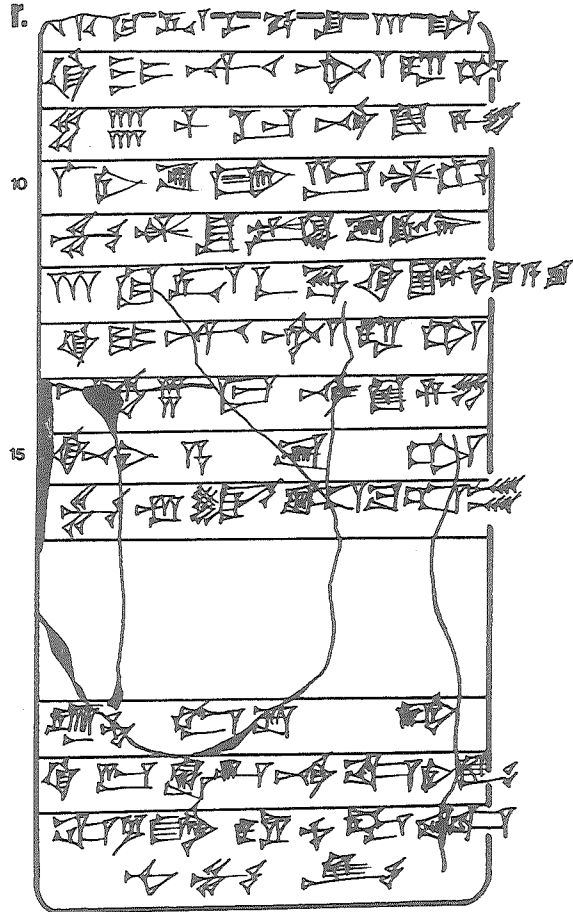
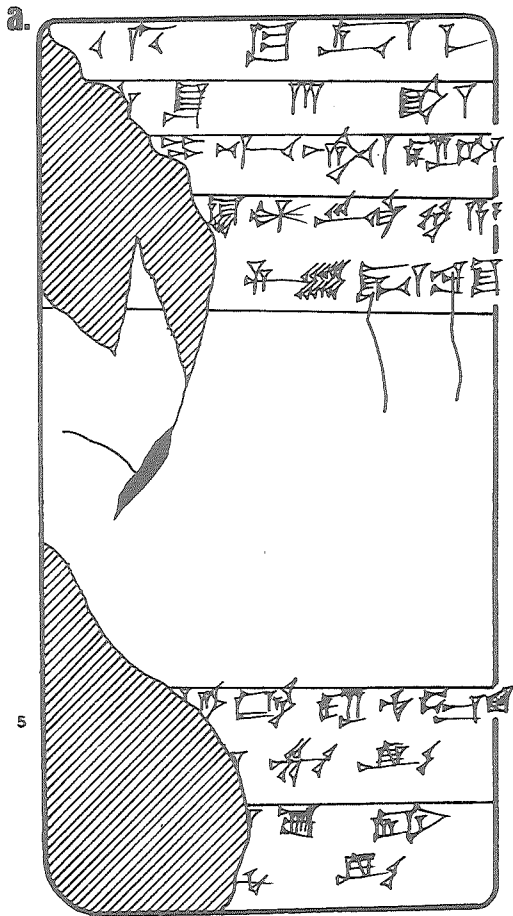

167 (MM 49)

AnOr 7 167
Drehem
Š41/vi/-

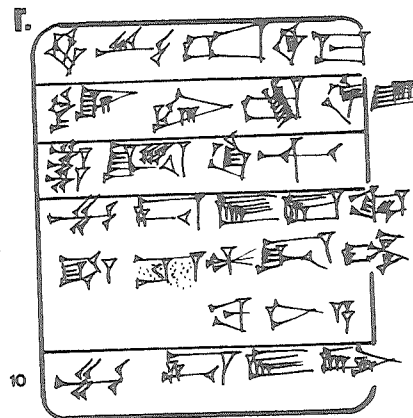
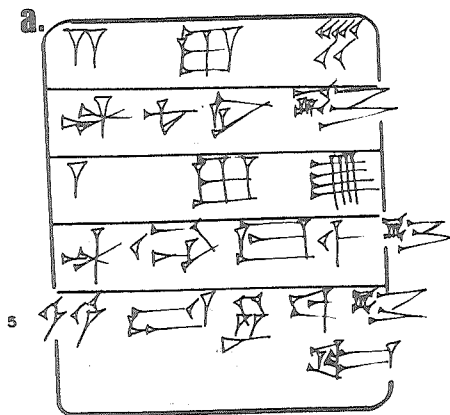

168 (MM 512)

AnOr 7 168
Umma
Š30' ó IS5'/viii/-

168. Sello:

˘Lugal˘-˘a₂˘-zi˘-˘[da˘]/ šeš-gal-˘gal˘ [...] arad₂ ˘š[ara₂]

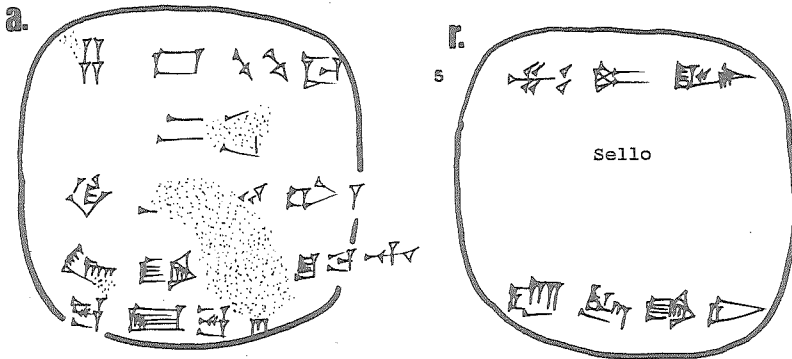

169 (MM 358)

AnOr 7 169
Umma
Š35/iv/-

169. Sello:

Di-ni-˘li₂˘
˘dub˘-˘sar˘
dumu Lu₂-k[ukku₂] (M[I.MII])

Reverso anepigráfico sellado

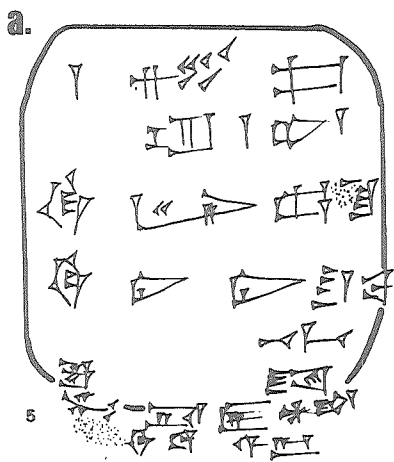

171 (MM 533)

AnOr 7 171
Umma
Š36/iii/-

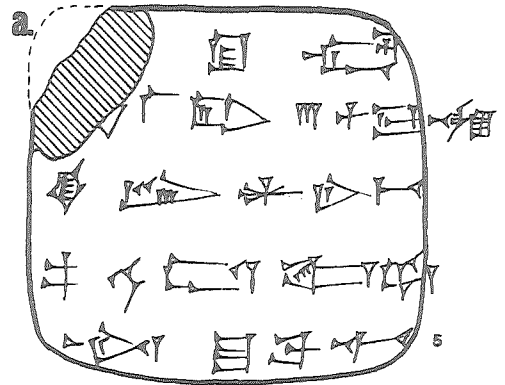

170 (MM 581)

AnOr 7 170
Umma
Š34/vii/-

170. Sello:

Ur-⁴Li₂-si₂
ensi₂ Umma⁴
Ku₂-ga-ni dub-sar
dumu Ur-⁴Šul-pa-[e₃]
arad₂-[zu]

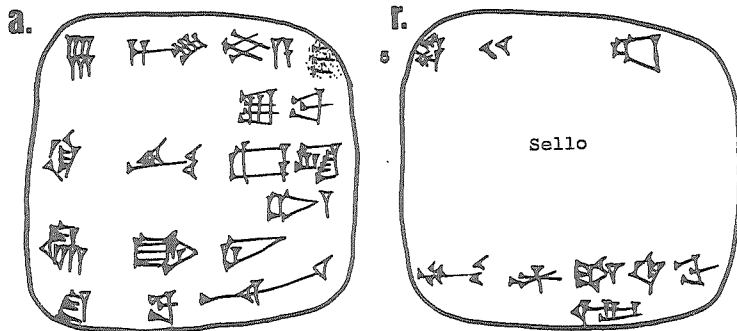
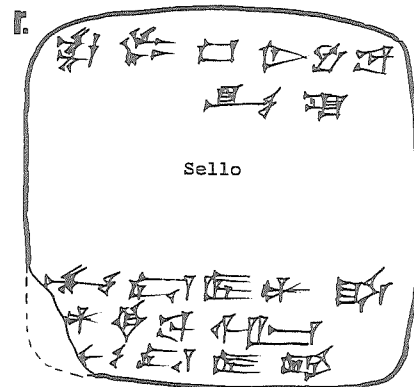

171. Sello:

[...]
dub-[sar]
dumu Ur-[...]

172 (MM 572)

AnOr 7 172
Umma
Š36/viii/-

172. Sello:

Ur^{d2}-[...]
dumu^d 

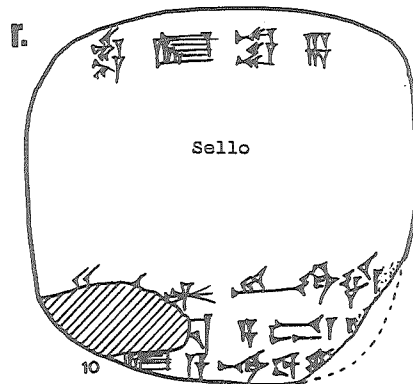
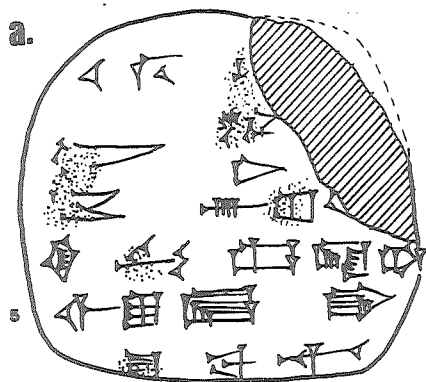

173 (MM 456)

AnOr 7 173
Umma
Š39/ix/-

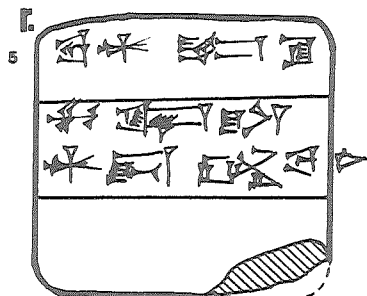
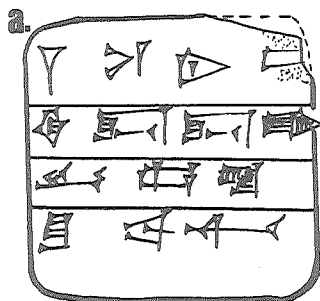

174 (MM 172)

AnOr 7 174
Umma
Š44/xii/[]

174. Sello:

[L]u₂-⁶Nin-šu[bur]
arad₂ ⁶Šara₂

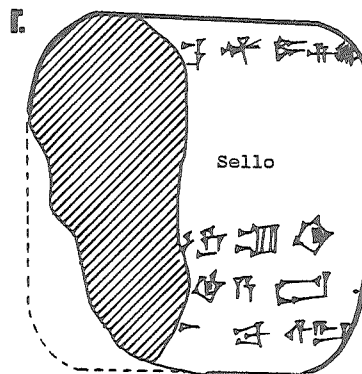
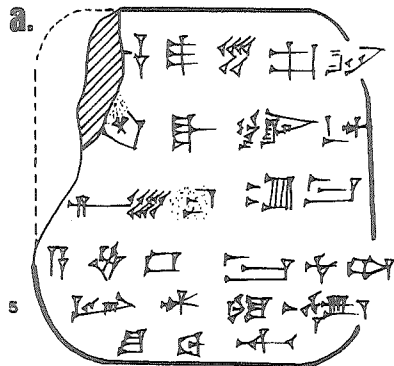

175 (MM 339)

AnOr 7 175
Umma
AS2/-/-

175. Sello:

Lugal-si-NE-e
dub-sar
dumu Lugal-ša₆-ga

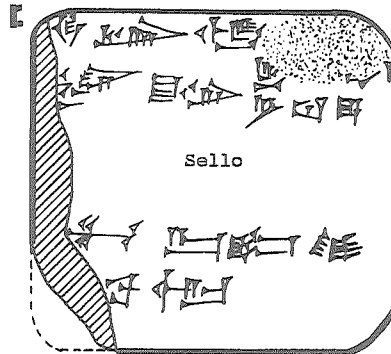
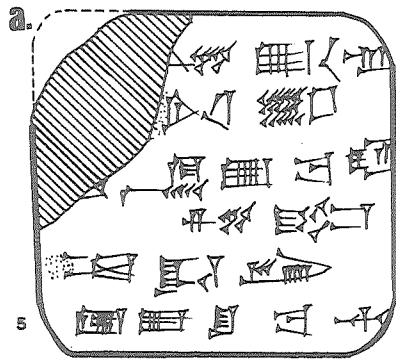

176 (MM 556)

AnOr 7 176
Umma
AS2/-/-

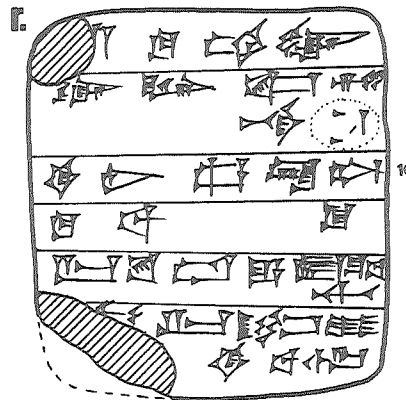

177 (MM 376)

AnOr 7 177
Umma
AS1/-/-

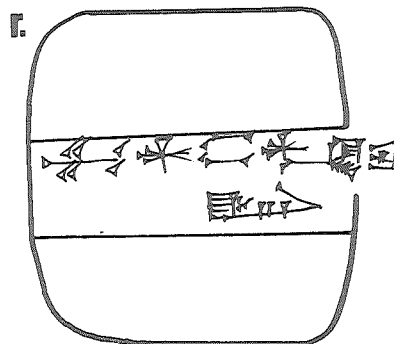
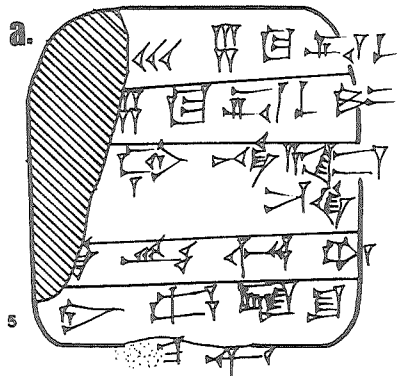

178 (MM 437)

AnOr 7 178
Umma
AS9/xiii/-

178. Sello:

Šeš-a-ni
dumu Kiri₁₇-zal-
Šul-gi-r[a?]-
k[a ...]

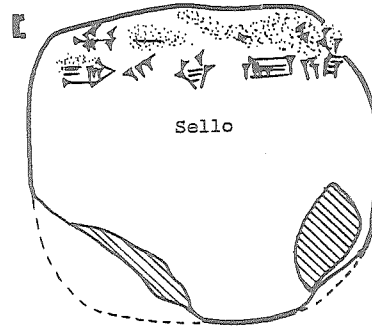
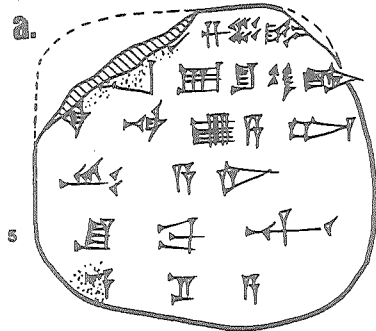

179 (MM 206)

AnOr 7 179
Umma
Š38/x/-

179. Sello:

A₂-da-ga¹⁷
Lu₂-ban₃-da
mu₆-sub₃ Šara₂

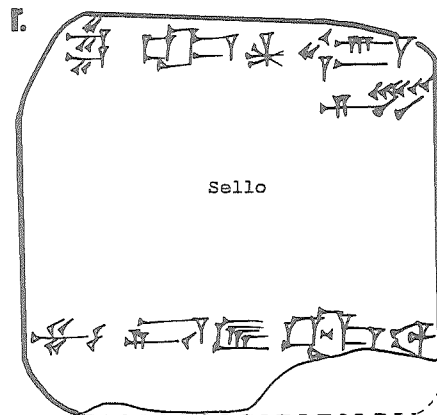
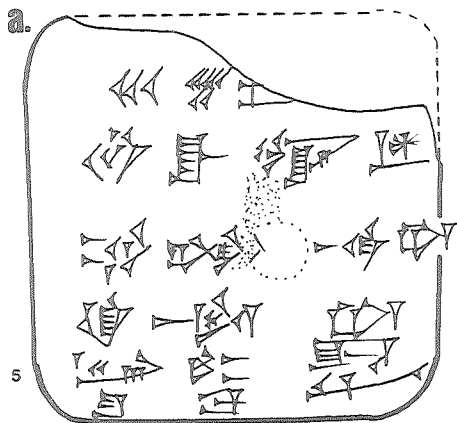

180 (MM 139)

AnOr 7 180
Umma
Š55/ix/-

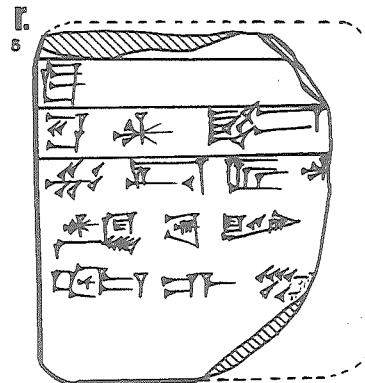
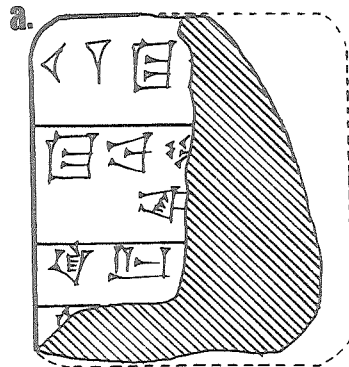

181 (MM 340)

AnOr 7 181
Umma
ŠS5/ix xi ó xii/3

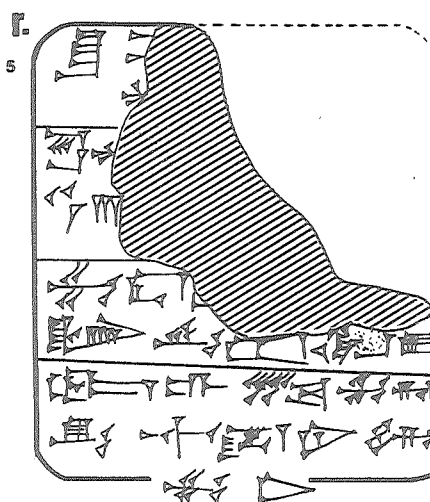
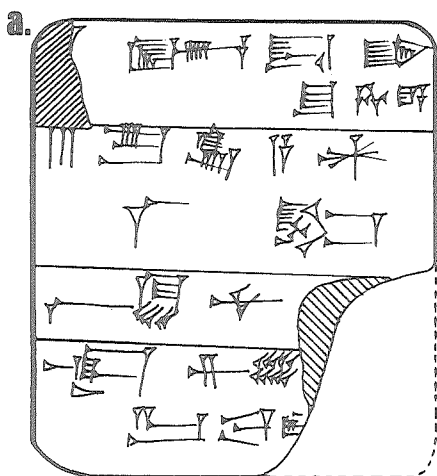

182 (MM 178)

AnOr 7 182
Umma
[]/ii/-

182. Sello:

Inim-^d[Šara,
dumu Ur-dingir-ra
kurušda ^d-Šara₂]

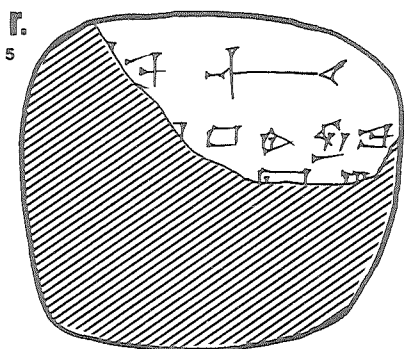
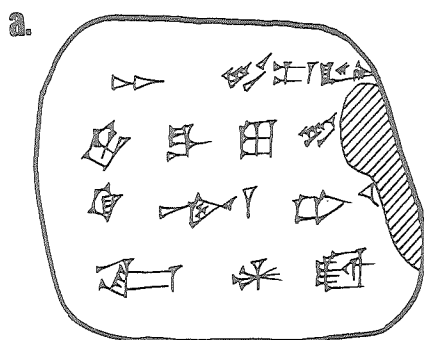

183 (MM 392)

AnOr 7 183
Umma
[]/vii/-

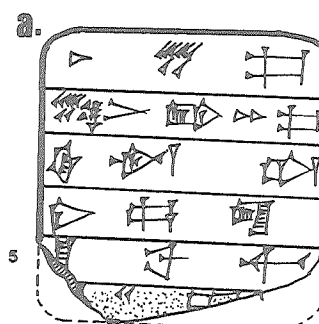

Reverso destruido y parte inferior anepigráfica

184 (MM 412)

AnOr 7 184
Umma
Š34/xii/-

184. Sello:

- i Ur-^dLi₉-si₂-na
ensi₂ Umma^{ki}
Ur-ša₂-ga
- ii dub-sar
dumu E₂-ki
arad₂-zu

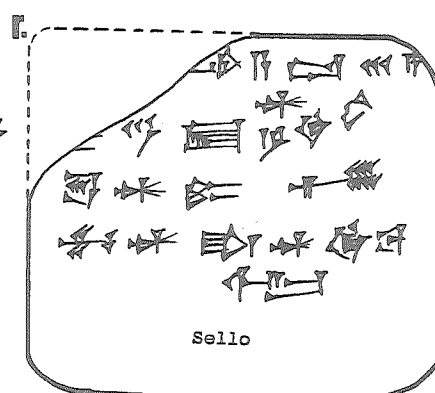
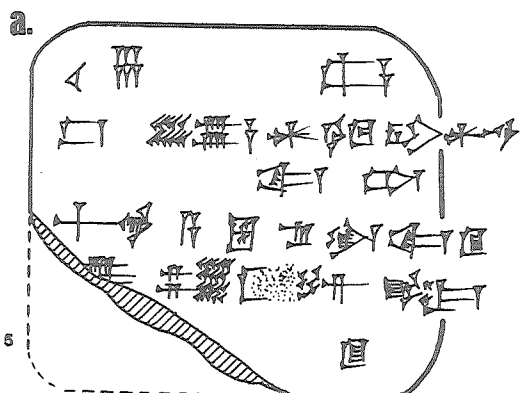

185 (MM 346)

AnOr 7 185
Umma
Š36/-/-

185. Sello:

Ur²Li₂si₄
ensi₂ Umma^{ki}
A-tu dub-sar
dumu Lugal-ša₆ga / arad₂-zu

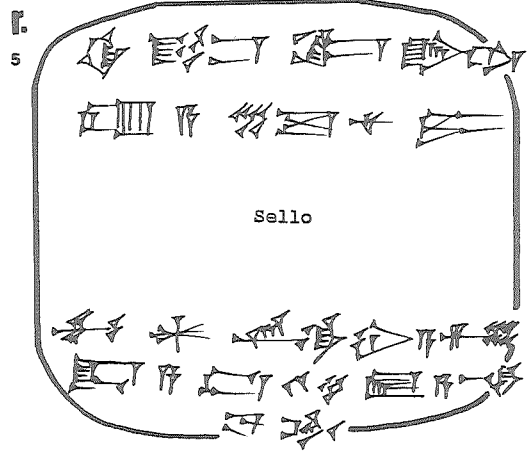
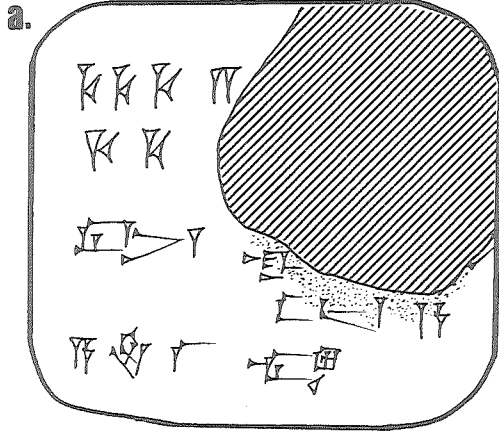

186 (MM 390)

AnOr 7 186
Umma
Š36/i/-

186. Sello:

Lu₂-he₂-gal₂
[dumu Ur]^{2B}gigir
[mu-sar] ⁴Šara₂

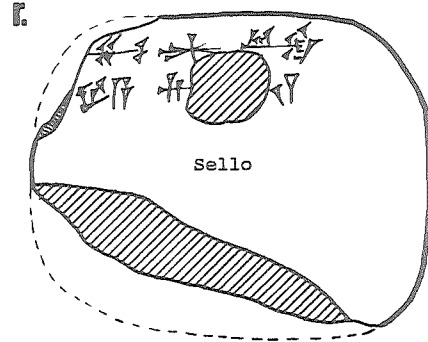
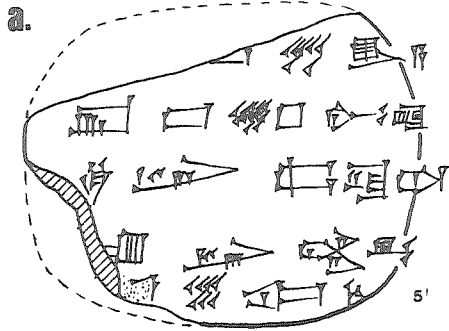

187 (MM 381)

AnOr 7 187
Umma
ŠS4/-/-

187. Sello:

A-kal-l[a]
dub-s[ar]
dumu Lu₂-ša₃-[ga]

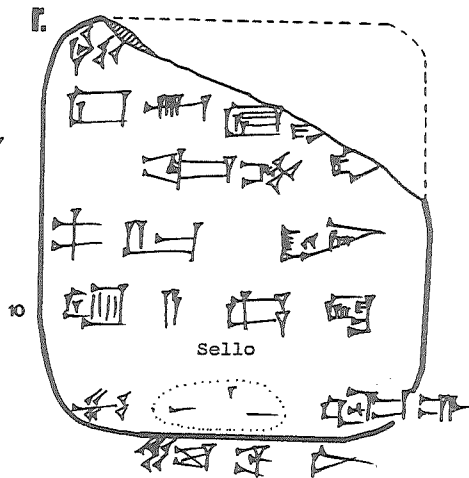
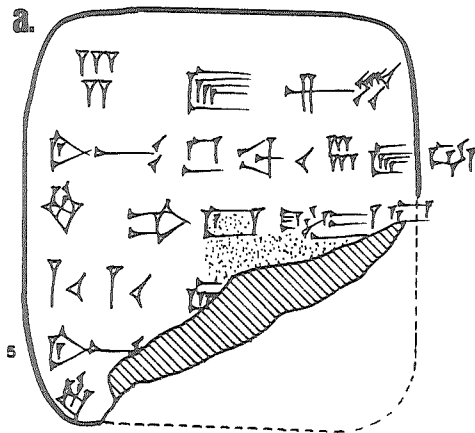

188 (MM 408)

AnOr 7 188
Umma
Š40/-/-

188. Sello:

Lu₂-ban₃-da
dub-sar
[dum]u x[...]

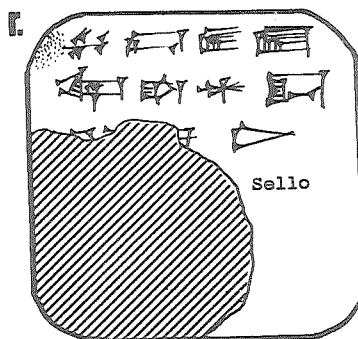
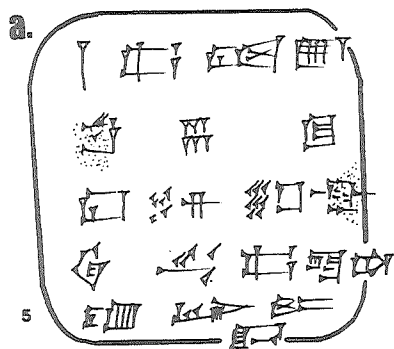

189 (MM 419)

AnOr 7 189
Umma
Š40/-/- {xii-vii}

189. Sello:

Lugal-[iti-da']
dub-[sar]
dumu Šeš-⁷kal-la⁷

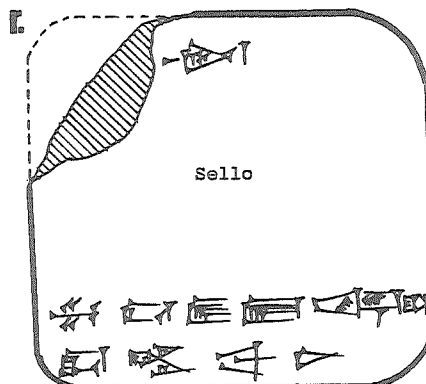
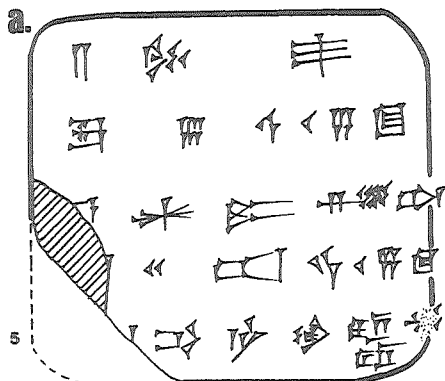

190 (MM 385)

AnOr 7 190
Umma
AS6/-/-

190. Sello:

Ur^d-Suen
dub-sar
dumu Ur^{su}-gigir

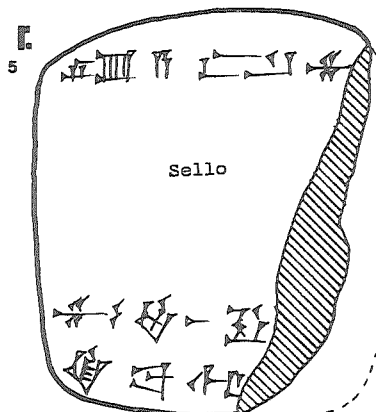
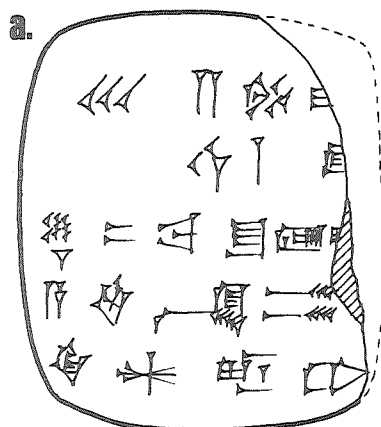

191 (MM 536)

AnOr 7 191
Umma
Š46/vi/-

191. Sello:

Ur-e₁₁-e
dub-sar
dumu Ur-ni₉-gar

Bulla con orificios para cuerda

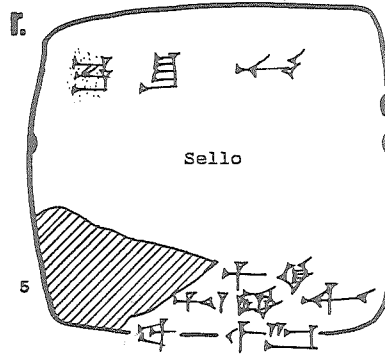
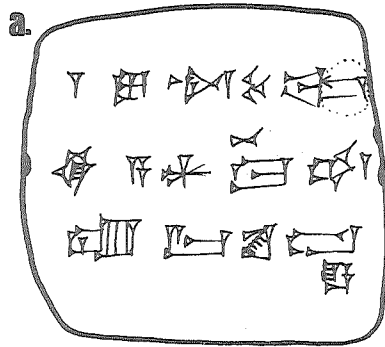

192 (MM 518)

AnOr 7 192
Umma
Š46 ó AS3/viii/-

192. Sello:

A-kal-la
dub-[sar]
dumu [...]

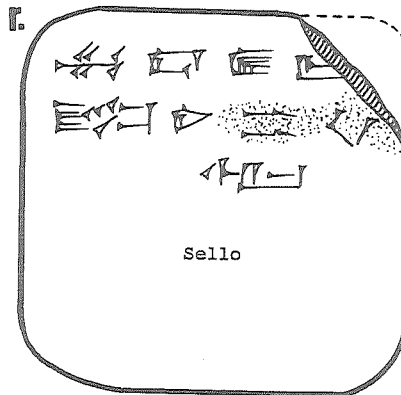
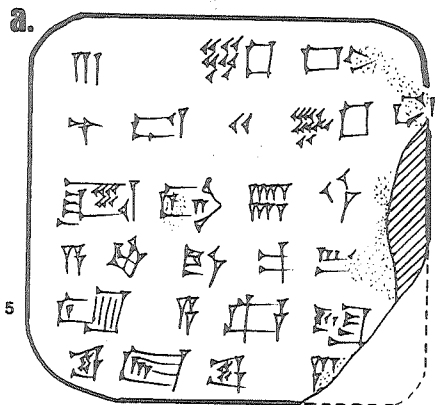

193 (MM 549)

AnOr 7 193
Umma
Š48/xiii/-

193. Sello:

Da-a-[gi]
dub-[sar]
Línea en blanco

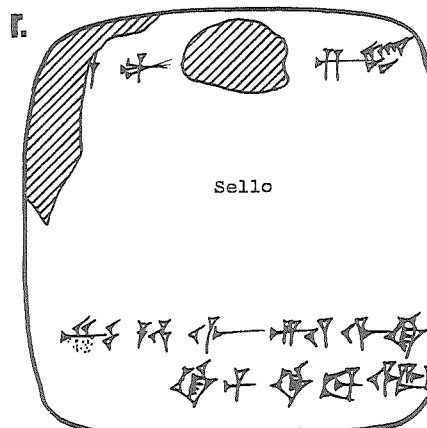
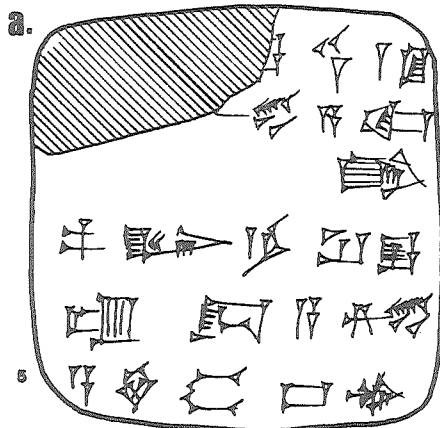

194 (MM 505)

AnOr 7 194
Umma
Š48/iii/21

194. Sello:

- i ^dŠul-gi
nita kal-ga
lugal Uri₂^{ki}-ma
lugal ^dUb₂-/da limmu₂-ba
- ii U[r-^dLi₂-si₂]
ensi₂
Umma^{ki}
arad₂-zu

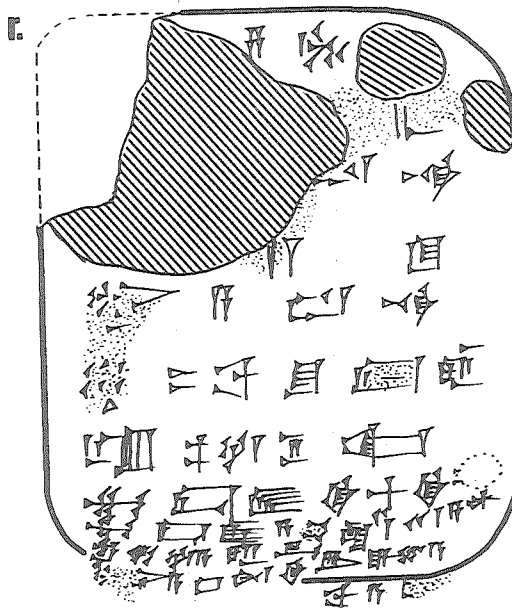
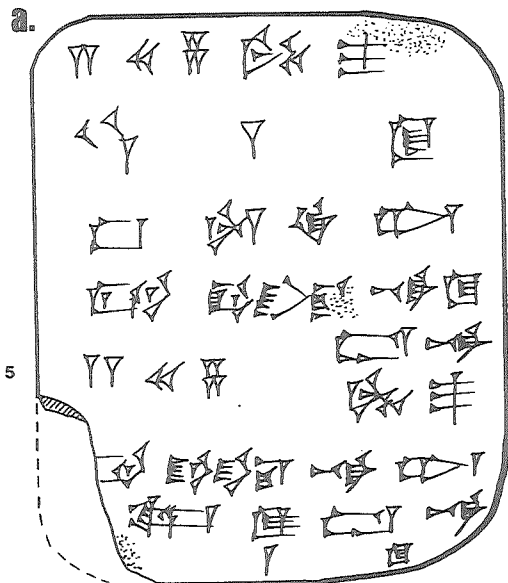

195 (MM 559)

AnOr 7 195
Umma
AS1/xii/-

195. Sello:

- Ur-[dun']
dub-[sar]
dumu Da-[da']

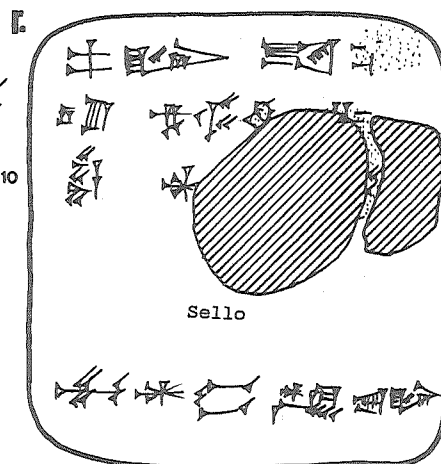
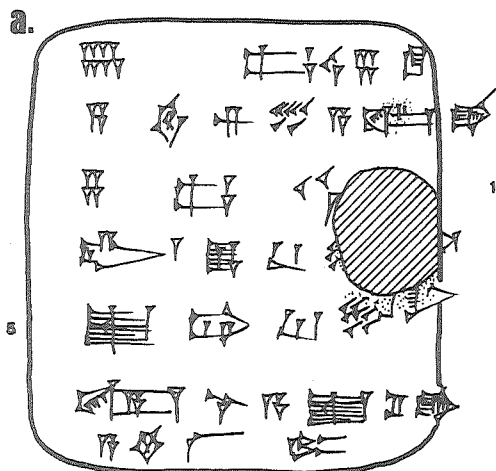

196 (MM 223)

AnOr 7 196
Umma
AS1/-/

196. Sello:

Uš-mu
dub-sar
dumu Lugal-ša₆[ga]

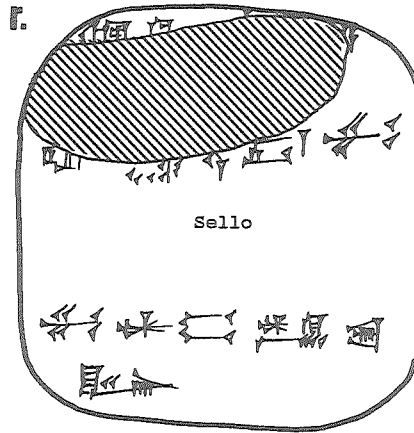
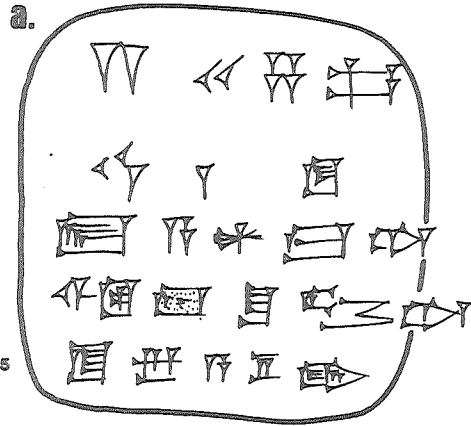

197 (MM 343)

AnOr 7 197
Umma
AS1/-/ {v, l}

197. Sello:

i ⁴Sul-gi
nita kal-ga
lugal Uri₃/⁴ma
lugal ⁴Ub-/da limmu₂-ba
ii Ur-⁴Li₅-si₄
ensi₂
Umma⁴
arad₂-zu

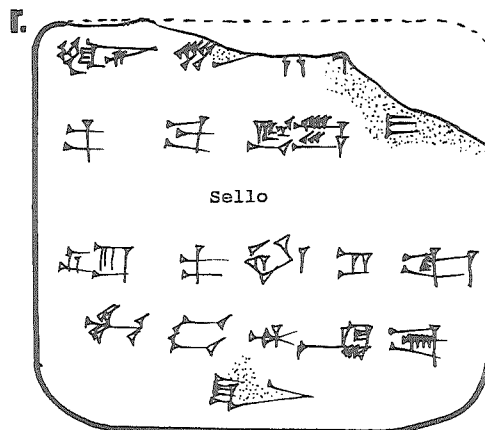
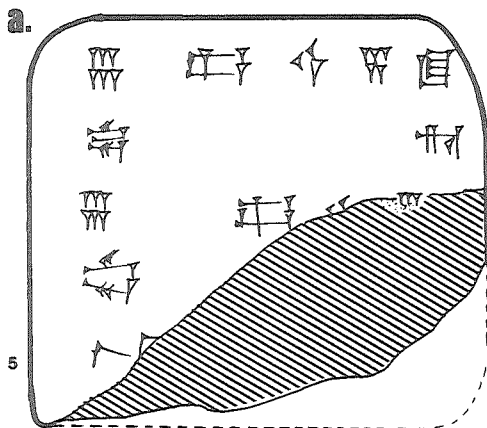

198 (MM 365)

198. Sello ilegible

AnOr 7 198
Umma
AS2/-/-

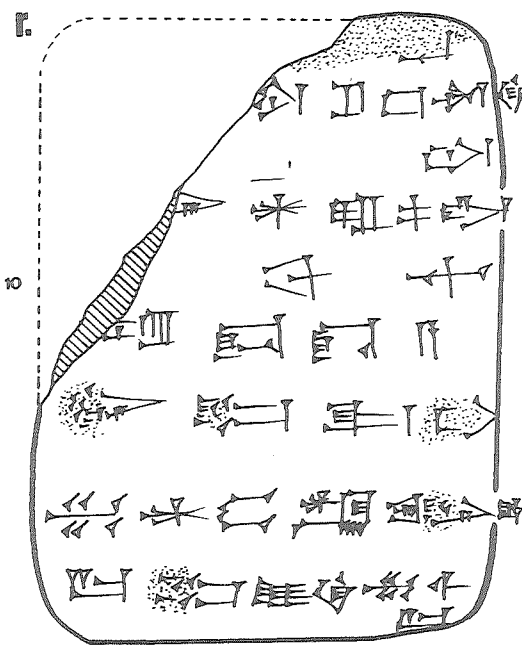
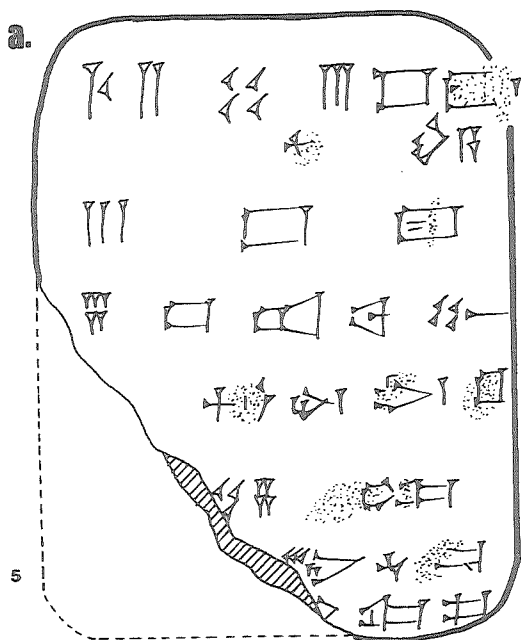

199 (MM 529)

199. Sello:

AnOr 7 199
Umma
AS2/-/-

Ur-²gigir²
dub-sar
dumu [Bar]-ra-[an]

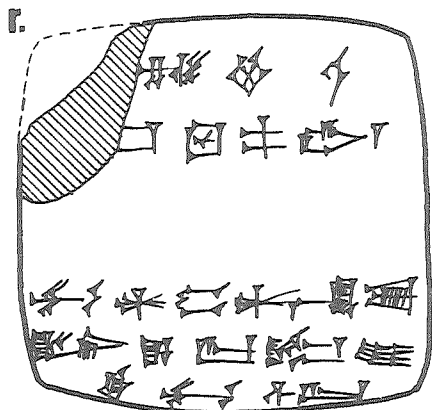
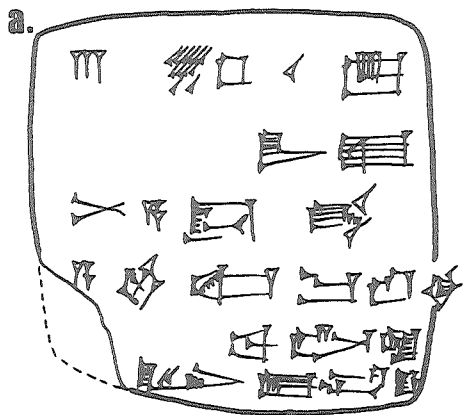

200 (MM 570)

200. Sello:

AnOr 7 200
Umma
AS2/-/-

I₁-pa-e₃
dumu Lugal-²nanga²
nu-banda₃ gu₄ ⁴Sara₂

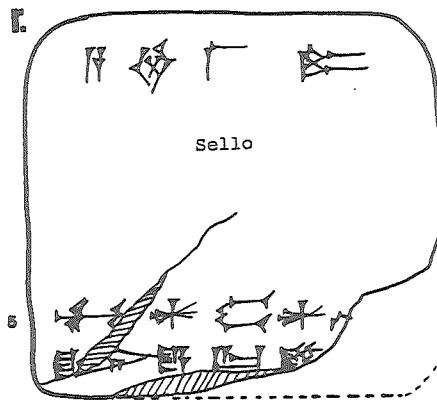
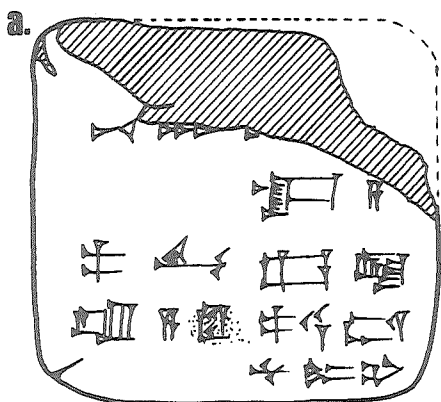

201 (MM 443)

AnOr 7 201
Umma
AS2/ix xi ó xii/-

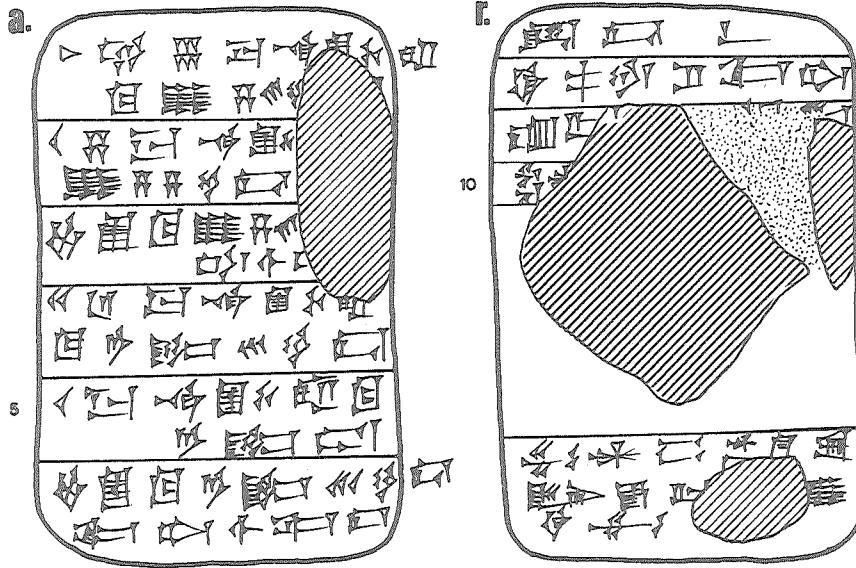

202 (MM 516)

AnOr 7 202
Umma
AS3/-/-

202. Sello:

Ur-⁴sara₂
dub-sar
dumu Lugal-nan[ga]

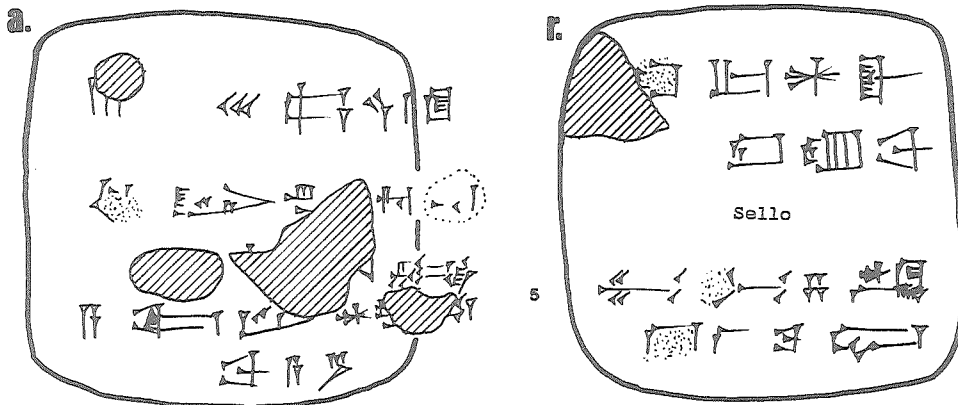

203 (MM 547)

AnOr 7 203
Umma
AS4/-/-

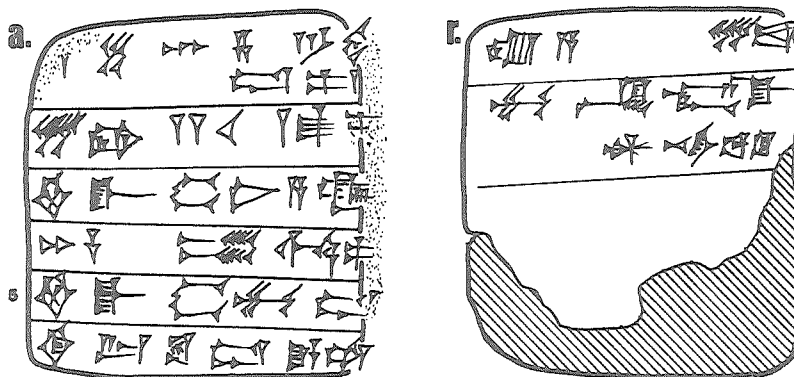

204 (MM 447)

AnOr 7 204
Umma
AS4/-/-

204. Sello:

Ur-⁴Šu-zi-[an-ka]
dub-[sar]
dumu Lugal-[iti-da]

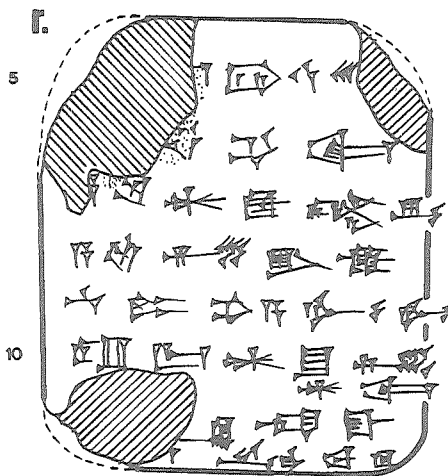
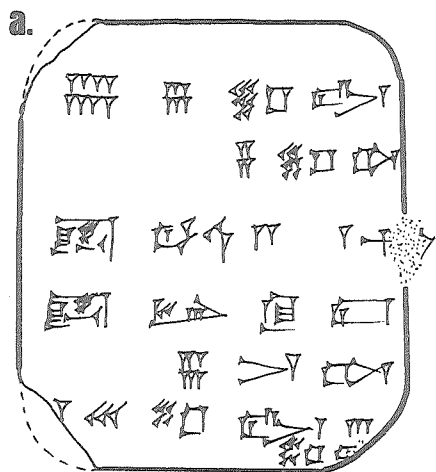

205 (MM 359)

AnOr 7 205
Umma
Š43 AS4 5 8 9 ó IS2/-/-

205. Sello:

Ur-⁴Li₂-s[i₂]
ensi₂ Umma^[a]
⁴Šara₂-ba-zi-[ge]
dub-sar arad₂-[zu]

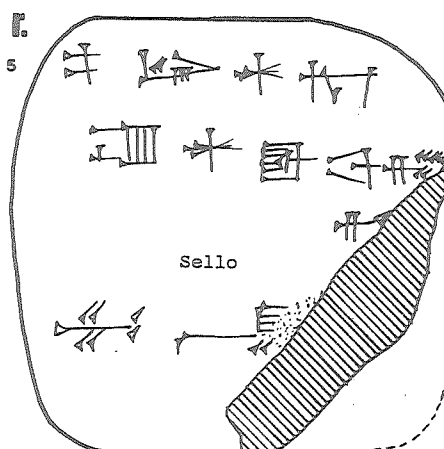
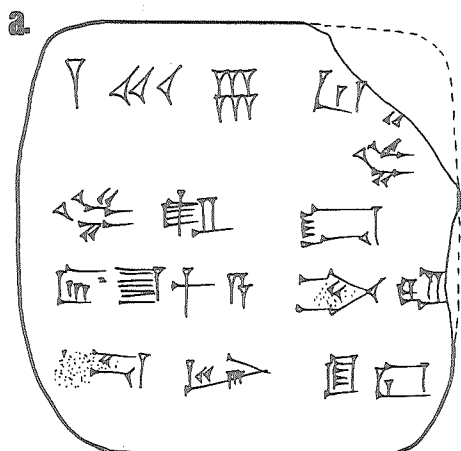

206 (MM 409)

AnOr 7 206
Umma
AS5/-/-

206. Sello:

Lu₂-⁴Šara₂-
dub-[sar]
dumu Uru-bar-[ra']
(Uru-bar- invertidos)

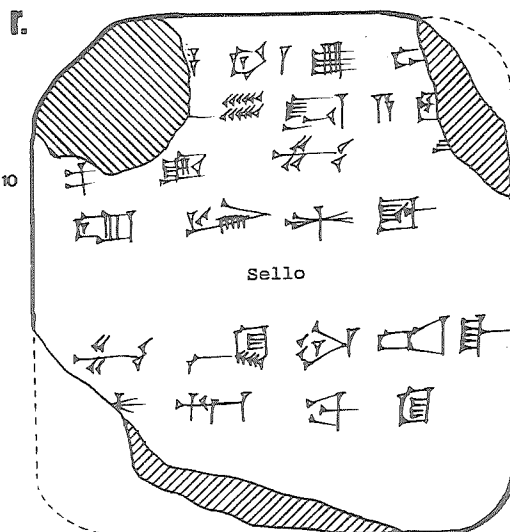
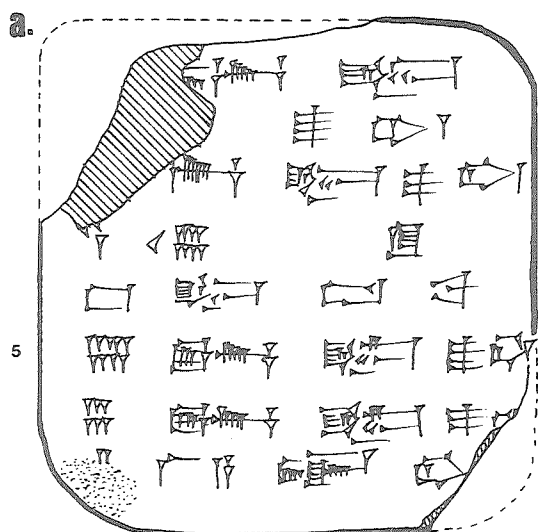

207 (MM 104)

AnOr 7 207
 Umma
 AS5/ix/-

207. Sello:

In⁻š[a₆-ša₆]
 dumu Bi₂-du₁₁-[mu]

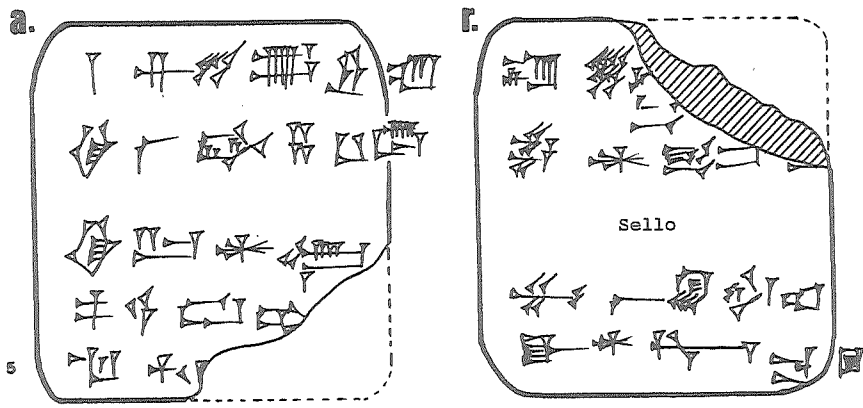

208 (MM 207)

AnOr 7 208
 Umma
 AS7/-/-

208. Sello:

Da-a-gi
 dub-sar
 Línea en blanco

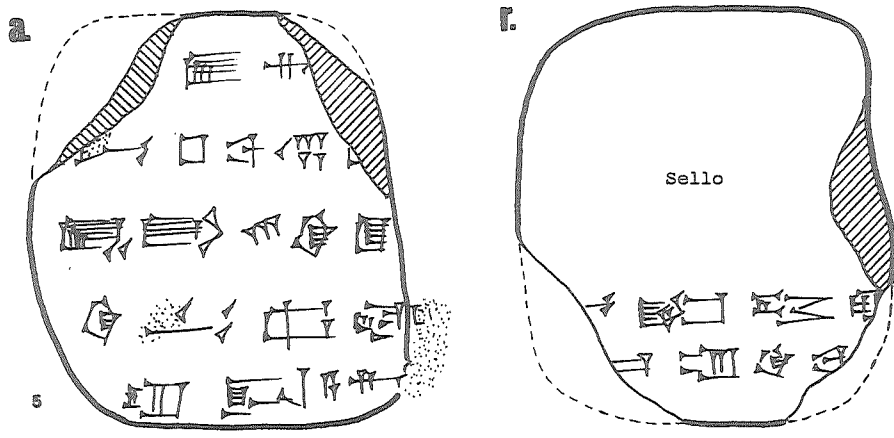

209 (MM 551)

AnOr 7 209
 Umma
 ŠS1/xi/-

209. Sello:

Ur⁻⁴Li₉-si₄
 ensi₂ Umma^{ti}
 Ur^{-2b}gigir
 arad₂-zu

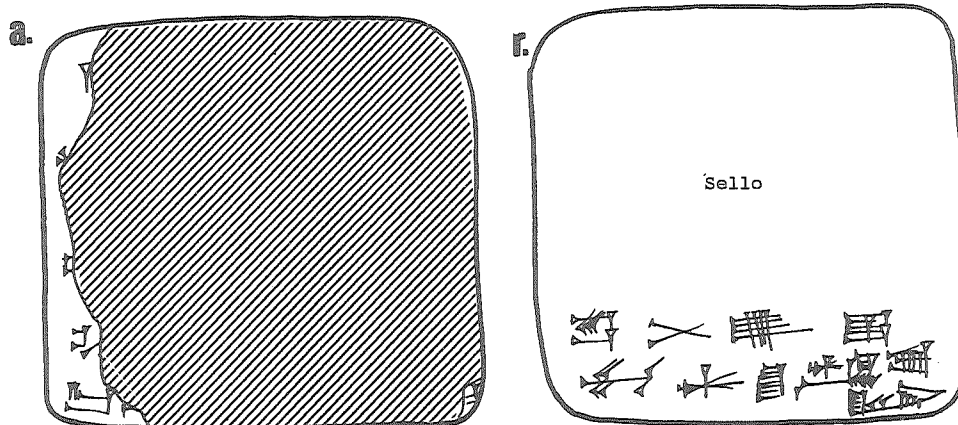

210 (MM 544)

AnOr 7 210
Umma
AS7/-

210. Sello:

[Inim-⁴]Šara₂
dub-sar
dumu Ur-ni₉-gar⁻

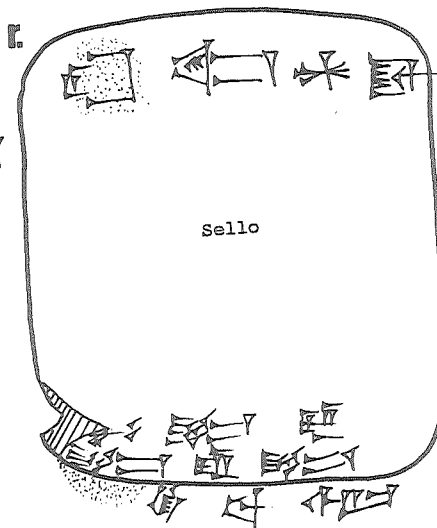
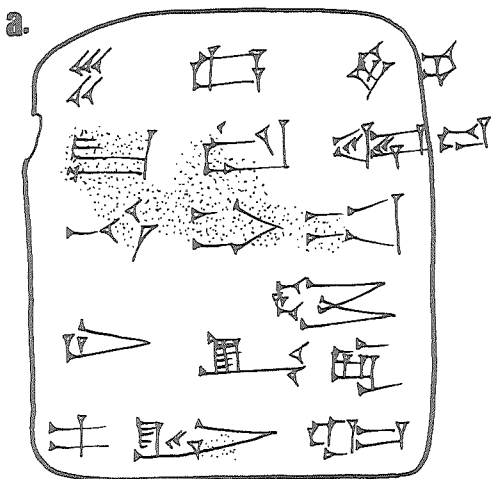

211 (MM 176)

AnOr 7 211
Umma
AS7/iv/-

211. Sello:

Lu₂-kal-la
dub-sar
dumu Ur-e₁₁-e kuš,

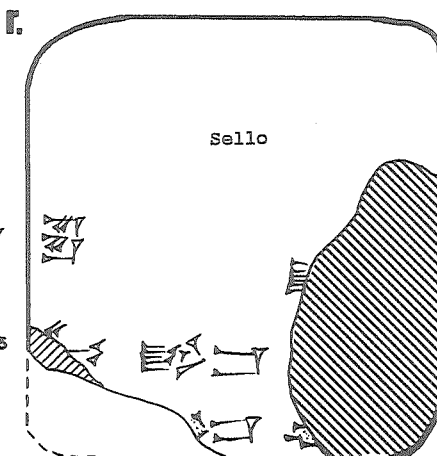
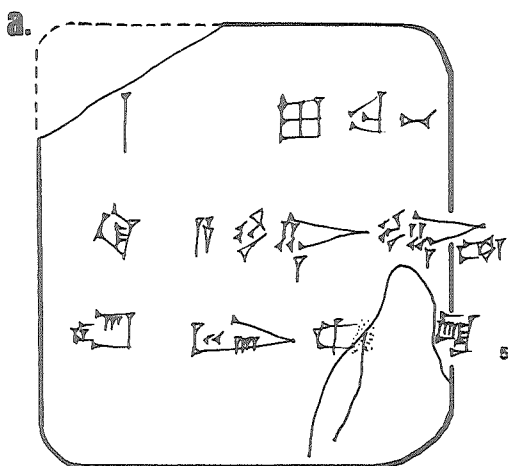

212 (MM 398)

AnOr 7 212
Umma
AS7/- (ix-xii)

212. Sello:

E₂-gal-e-si
dub-sar
dumu Lu₂-⁴Šara₂
sa₁₂-du₅-[ka]

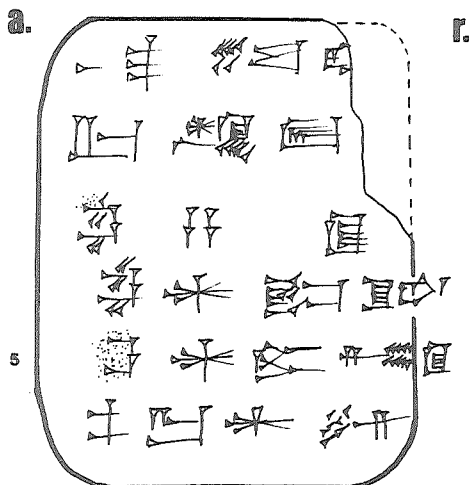

213 (MM 112)

AnOr 7 213
Umma
AS8/-/-

213. Sello:

Gu-u₂-gu-a
dub-sar
dumu Ma-an-sum

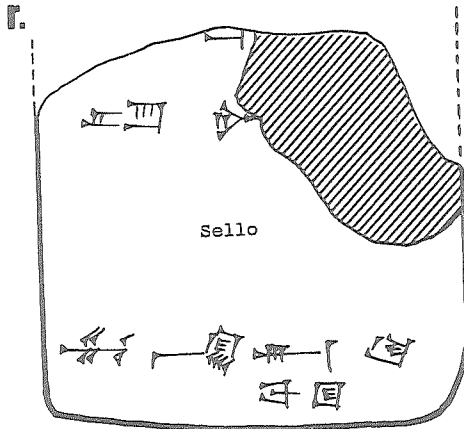
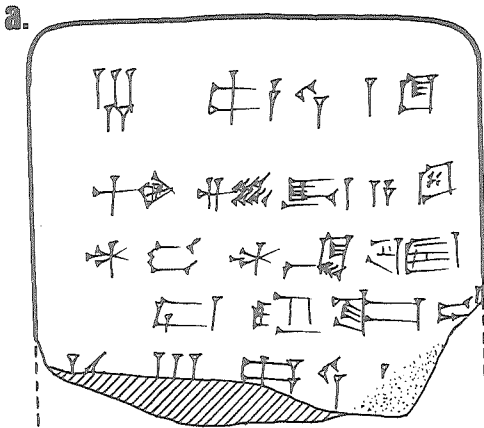

214 (MM 168)

AnOr 7 214
Umma
AS9/-/-

214. Sello:

Lugal-ku₃-ga-ni
dumu Ur-me[s]

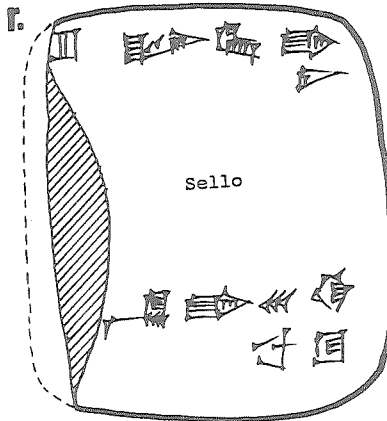
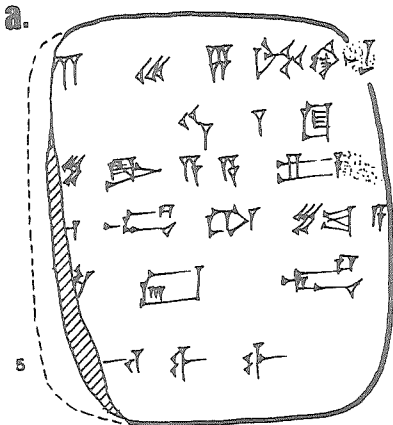

215 (MM 169)

AnOr 7 215
Umma
AS9/-/-

215. Sello:

Ur-d[un]
dub-[sar]
dumu Da-d[a]

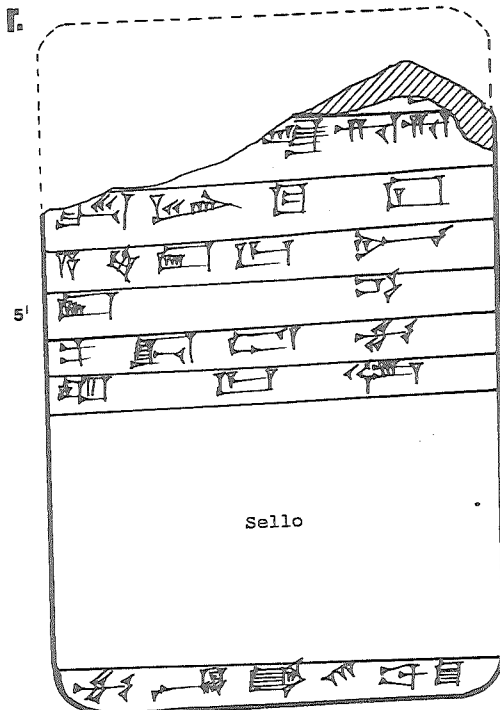
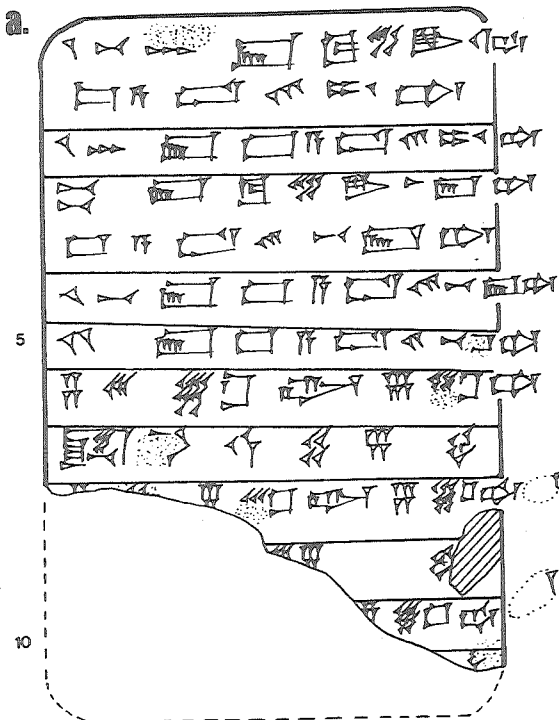

216 (MM 391)

AnOr 7 216
Umma
AS9/[?]/-

216. Sello:

L[ugal-e-ba-an-ša₆]
dub-[sar]
dumu Ur-⁴Īš[aran]

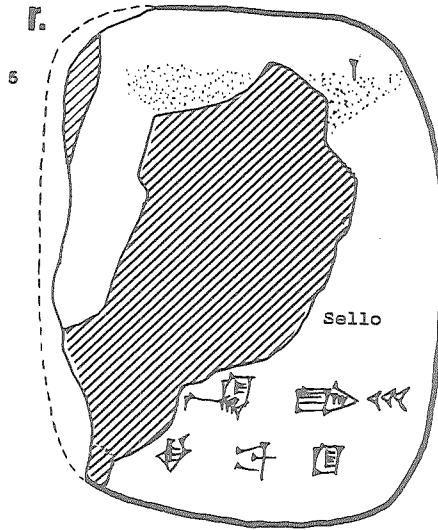
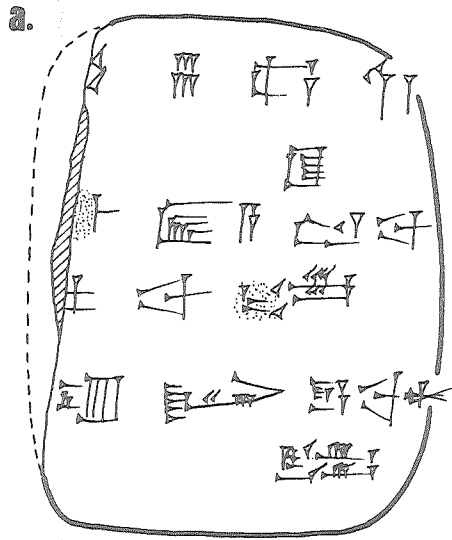

217 (MM 403)

AnOr 7 217
Umma
AS9/-/-

217. Sello:

Lugal-e₂-[ma]h-[e]
[dub-sar]
[dumu] Lugal-ku₃-ga-[ni]

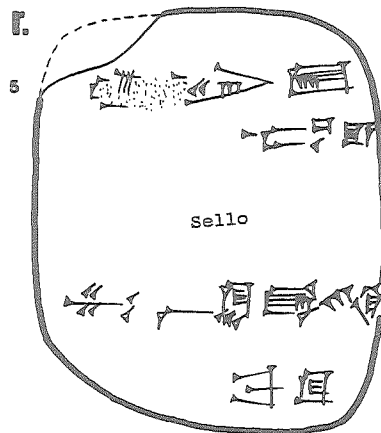
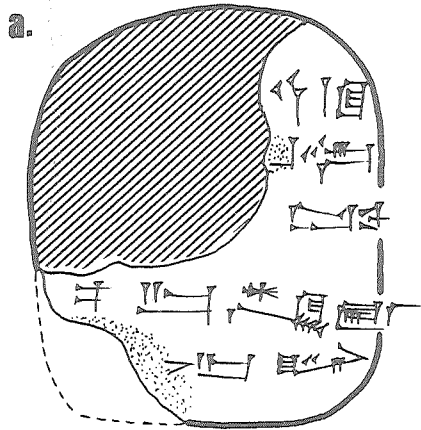

218 (MM 379)

AnOr 7 218
Umma
AS9/-/-

218. Sello:

Ur-mes
dub-sar
dumu Ur-⁴Nisaba

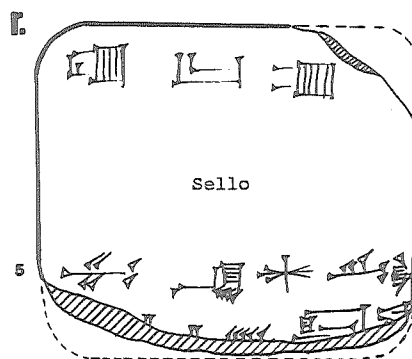
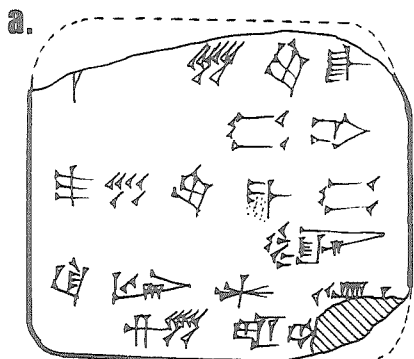

219 (MM 503)

AnOr 7 219
 Umma
 AS9/-/ (vii,v,[])

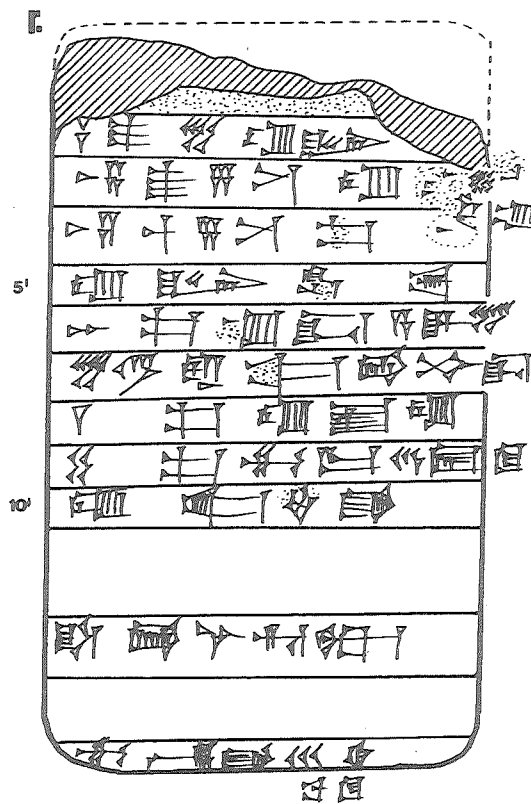
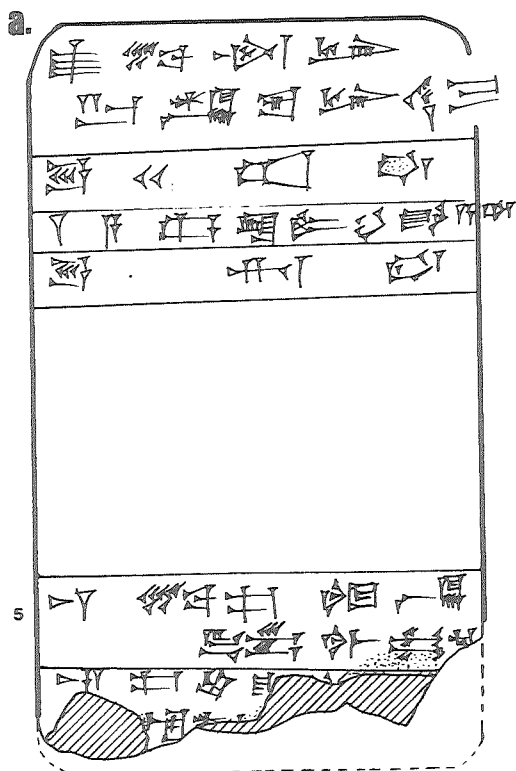

220 (MM 229)

AnOr 7 220
 Umma
 ŠS1/-/

220. Sello:

Ur-^dŠul-pa-e₃
 dub-sar
 dumu Lugal-ku₃-ga-ni

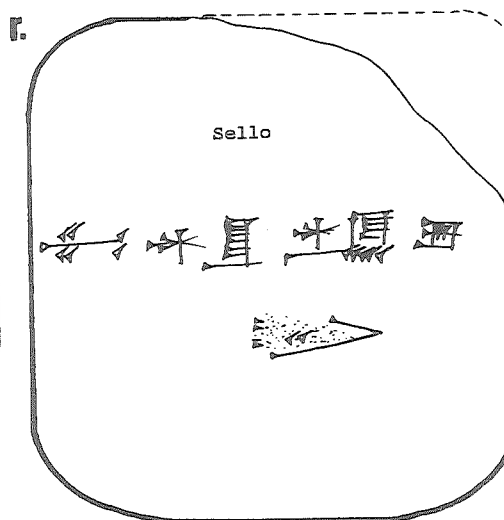
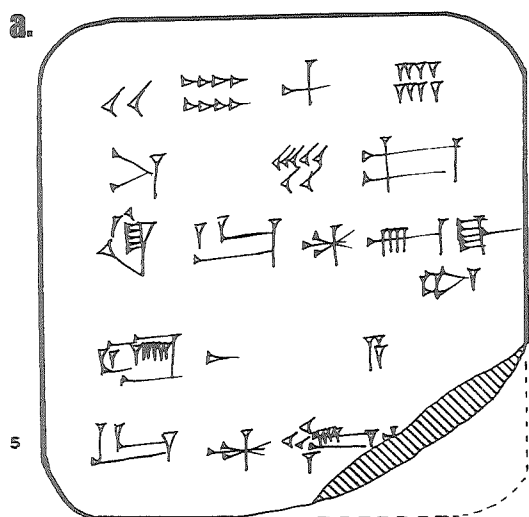

221 (MM 380)

AnOr 7 221
Umma
ŠS1/-/

221. Sello:

- i ^dŠu-^dSuen
lugal kal-ga
lugal Uri₂/^{ki}-ma
lugal ^dUb-/da limmu₂-ba
- ii A-a-^rkal-la^r
ensi₂
Umma^{ki}
arad₂-zu

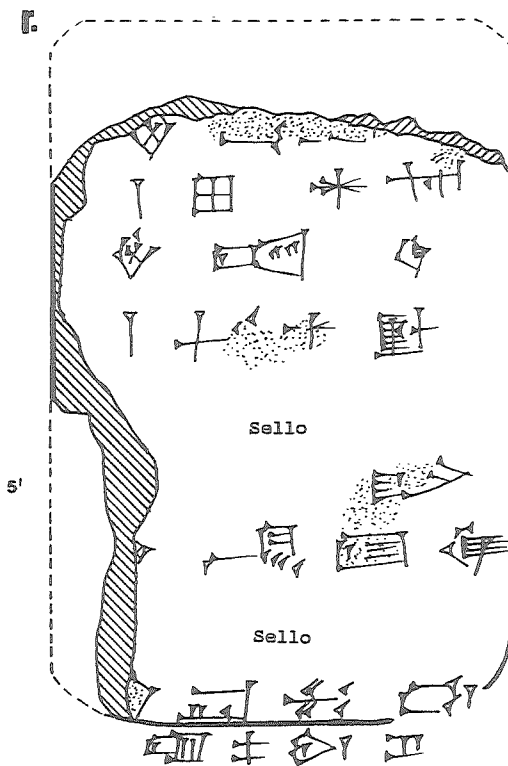
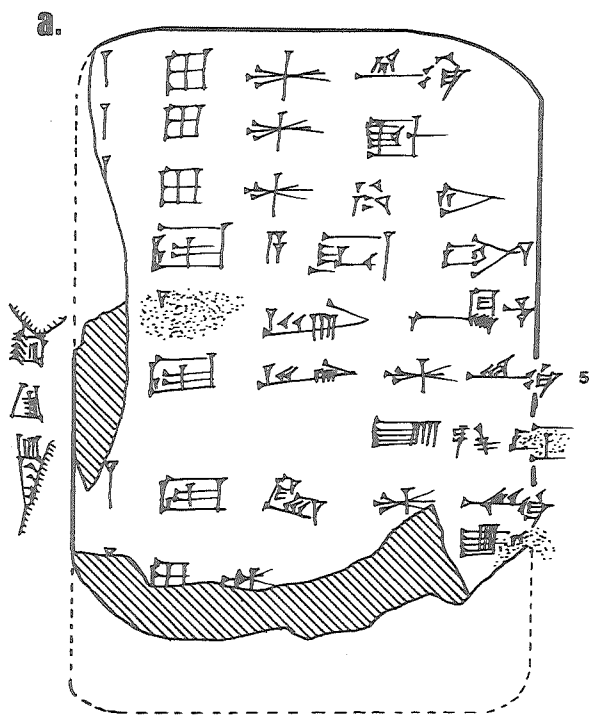

222 (MM 514)

AnOr 7 222
Umma
ŠS1/-/

222. Sello:

Lugal-e-ba-an-ša₆
dub-sar
dumu Ur-^dIšta[ran]

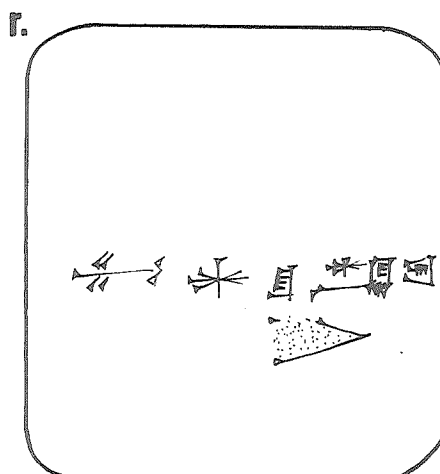
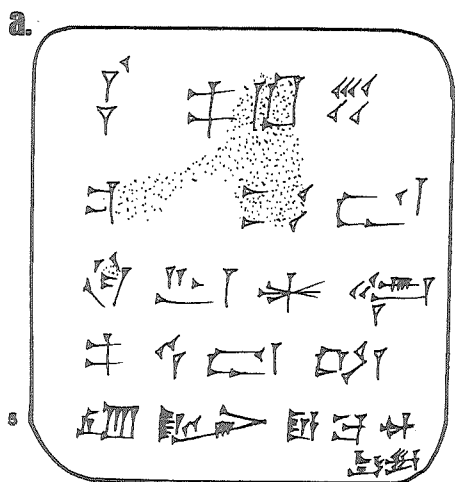

223 (MM 548)

AnOr 7 223
 Umma
 ŠS1/-/

223. Sello:

Inim-⁴[Šara₂]
 dumu Ur-^rni, ^r-[gar]

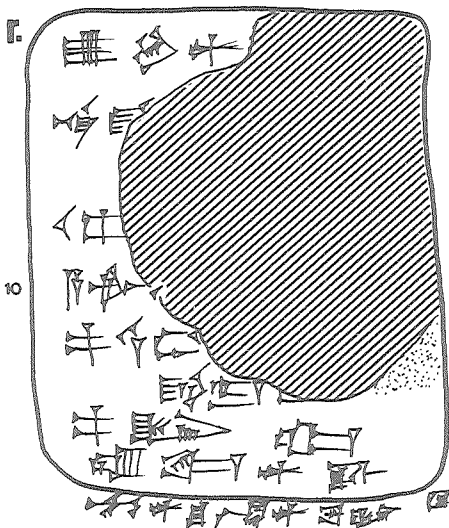
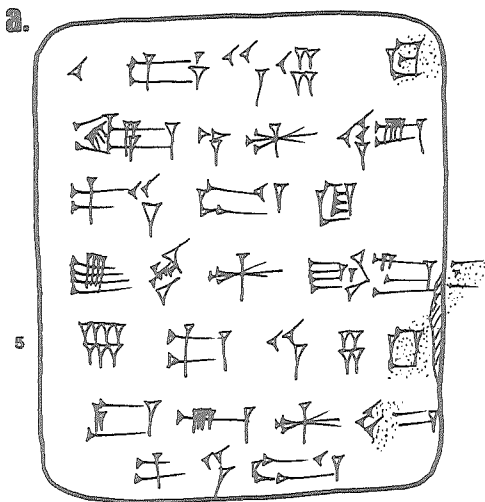

224 (MM 450)

AnOr 7 224
 Umma
 ŠS1/-/

224. Sello:

Ur-⁴Ma-[mi]
 dub-[sar]
 dumu Lugal-e-ba-an-[ša₂]

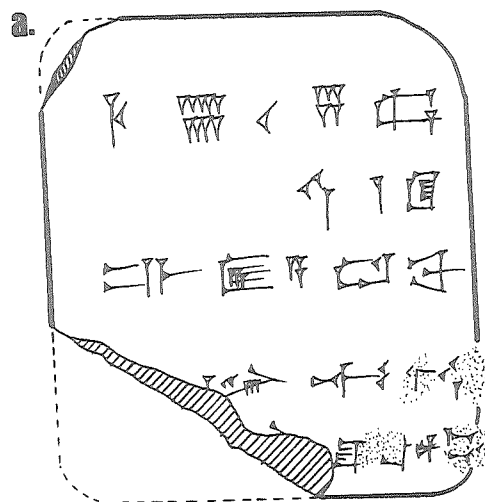

225 (MM 411)

AnOr 7 225
 Umma
 ŠS1/vi/-

225. Sello:

A-kal-la
 dumu Lu₂-bulug₃-ga₂
 ašgab gal

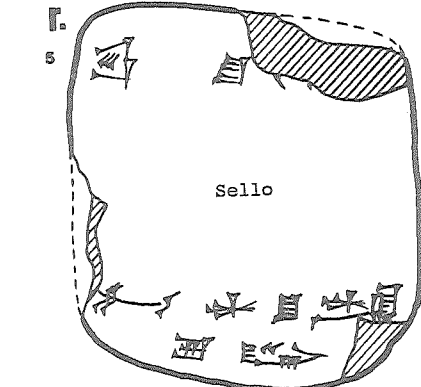
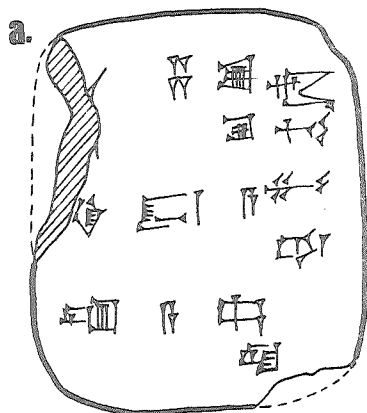

226 (MM 144)

AnOr 7 226
Umma
ŠS6/- (v-xii, i-xii)

226. Sello:

Lu₂-kal-[la]
dub-sar
dumu Ur-e₁₁-e [kuš₇]

Pl. LXXXV

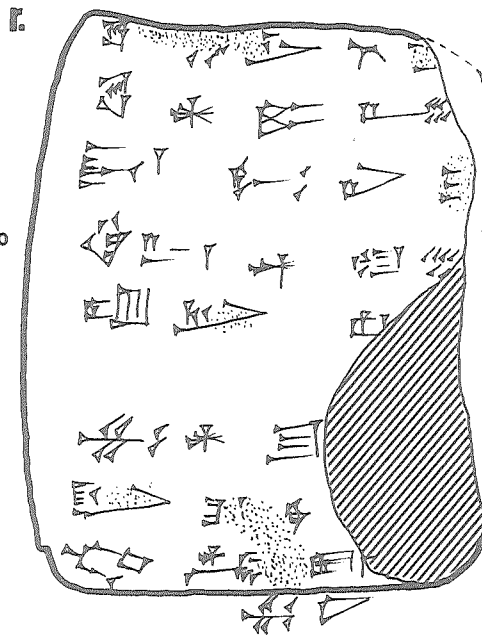

227 (MM 434)

AnOr 7 227
Umma
ŠS1/vii/-

227. Sello:

A-kal-la
dumu Lu₂-bulu₃-ga₂
ašgab gal

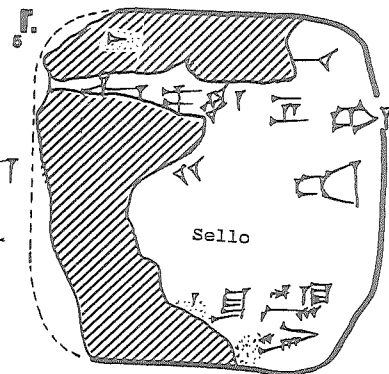
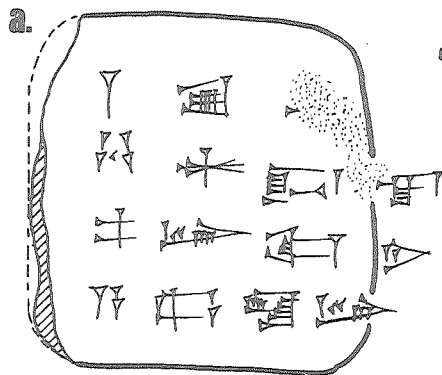

228 (MM 126)

AnOr 7 228
Umma
ŠS1/ix - ŠS2/xii

228. Sello:

Dingir-ra
dub-sar
dumu Lu₂-ga

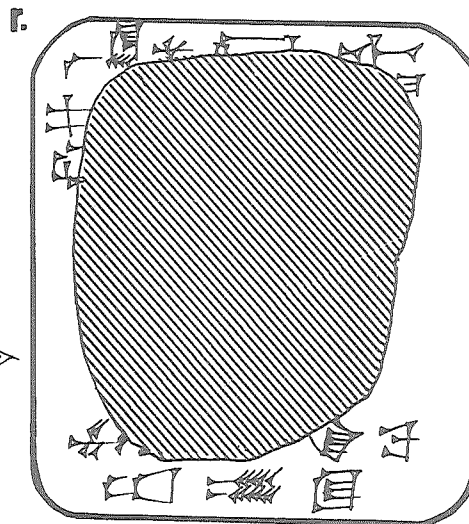
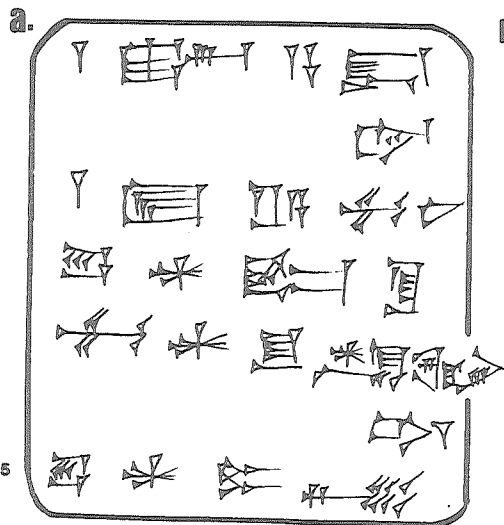

229 (MM 129)

229. Sello:

Ur-lugal
dub-sar
dumu Da-a-gi⁴

AnOr 7 229
Umma
SS2/1-

Perdidos aprox. 3 ó 4 cm de la tablilla

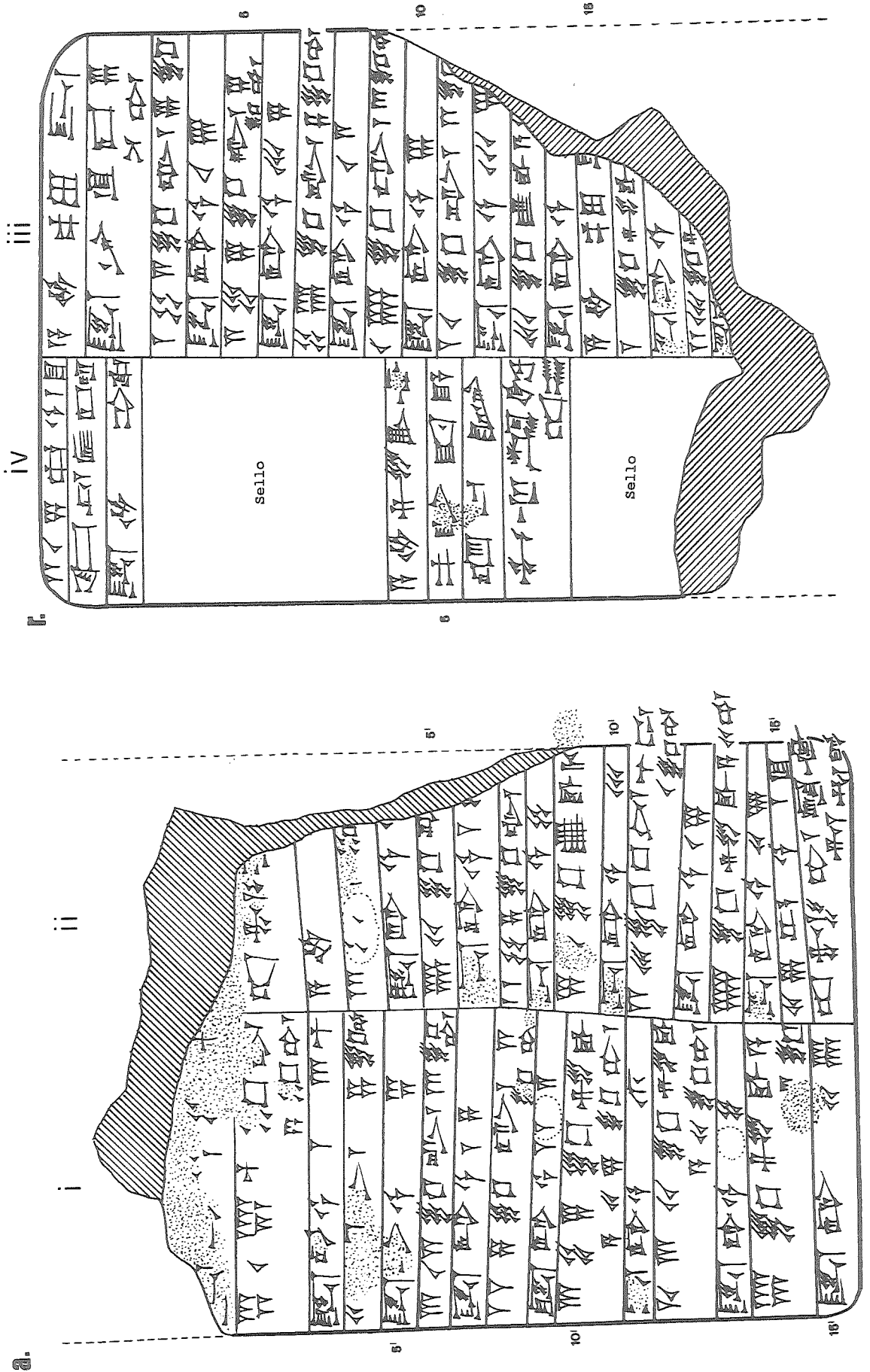

230 (MM 349)

AnOr 7 230
Umma
ŠS2/-/

230. Sello:

Lu₂-⁴Ha-ia₃
dub-sar
dumu Ur-e₁₁-e kuš,

Pl. LXXXVII

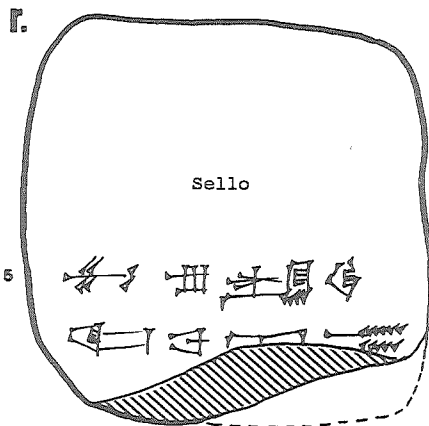
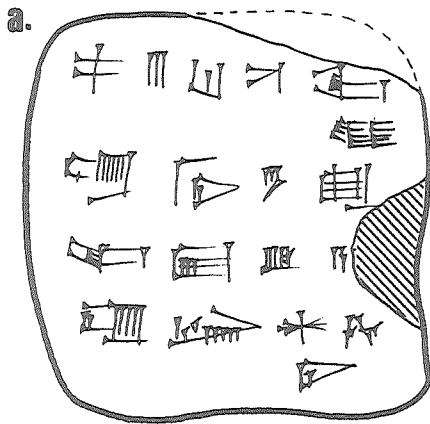

231 (MM 550)

AnOr 7 231
Umma
ŠS2/-/

231. Sello:

Da-a-ga
dub-sar
dumu Ur-giš-ša₃-ga

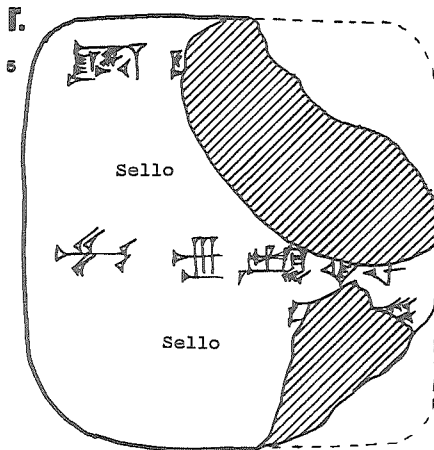
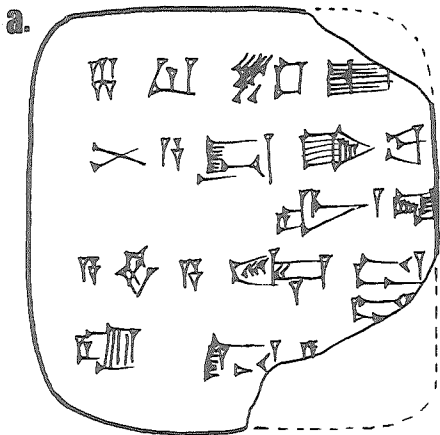

232 (MM 593)

AnOr 7 232
Umma
ŠS3/-/

232. Sello:

Lugal-e₂-[mah-e]
dub-[sar]
dumu Lugal-ku₃-[ga-ni]

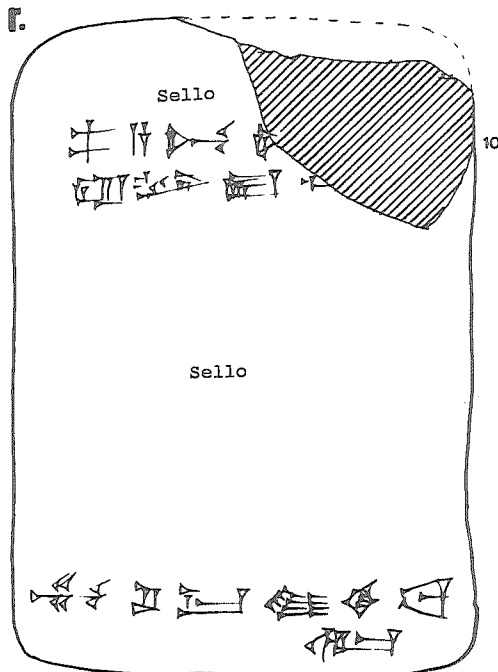
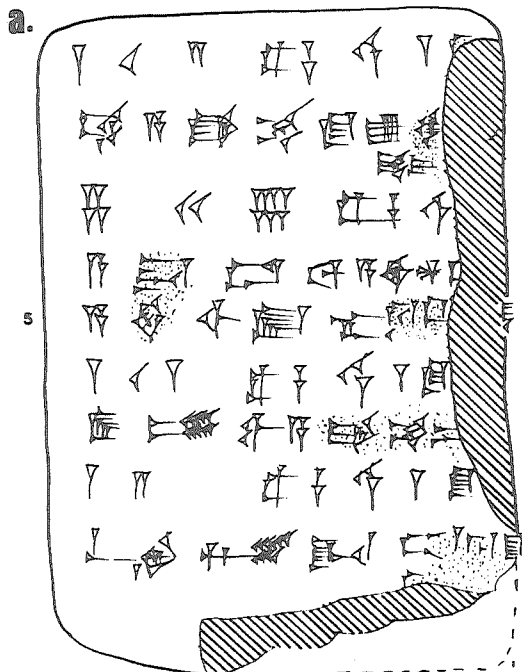

233 (MM 368)

AnOr 7 233
Umma
ŠS3/-/

233. Sello:

In[im-^d...]
dumu x[...]
ga^r-[L₂]

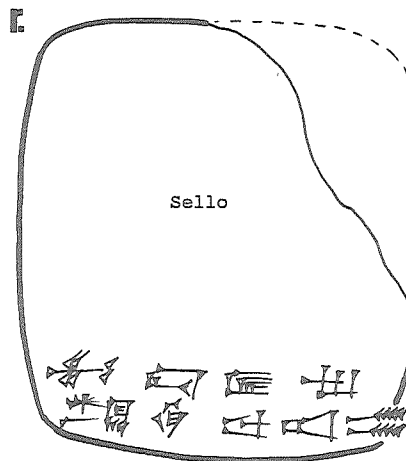
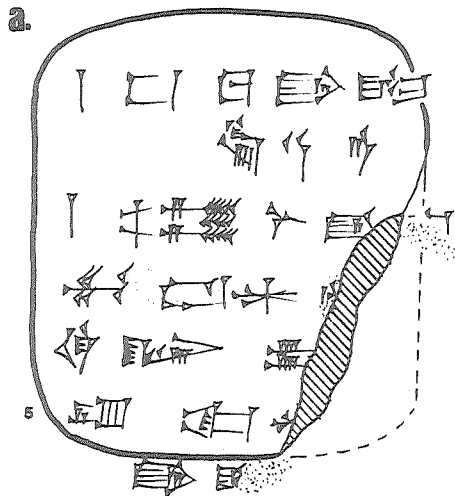

234 (MM 421)

AnOr 7 234
Umma
ŠS3/-/

234. Sello:

Šeš-kal-[la]
dub-[sar]
dumu Lugal-ma₂-gur₆-r[e]

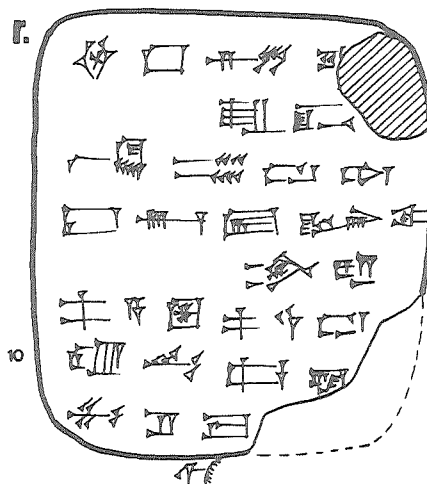
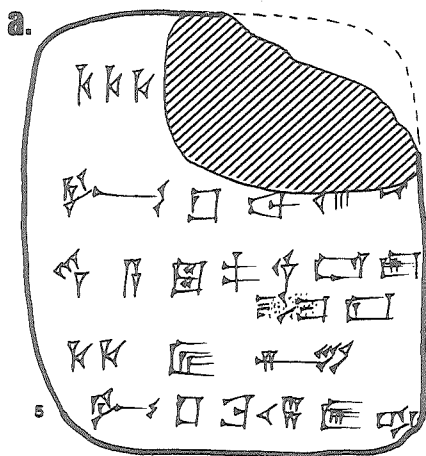

235 (MM 498)

AnOr 7 235
Umma
ŠS3/ii/-

235. Sello:

Lu₂-kal-la
dub-sar
dumu Ur-e₁₁-e kuš,

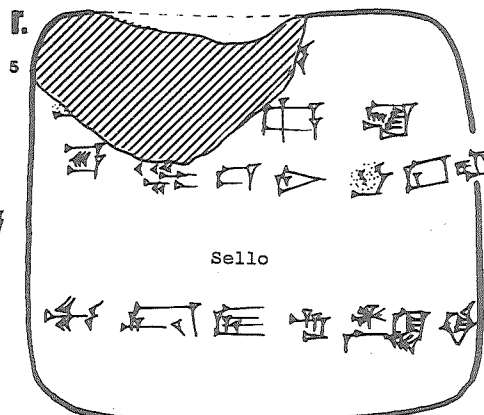
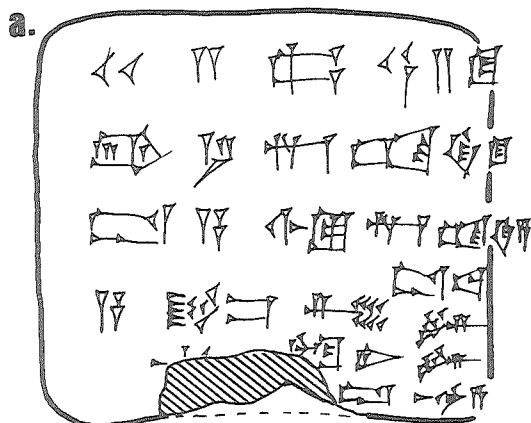

236 (MM 232)

AnOr 7 236
Umma
ŠS3/vii/-

236. Sello:

Al-la-igi-še₃-DU
dub-sar
dumu Ur-a-a-mu

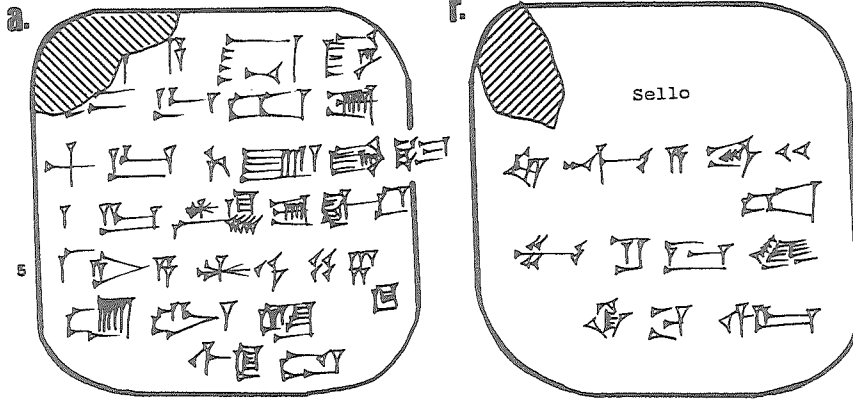

237 (MM 600)

AnOr 7 237
Umma
ŠS4/-/-

237. Sello:

Gu-u₂-gu-a
dub-sar
dumu Ma-an-sum

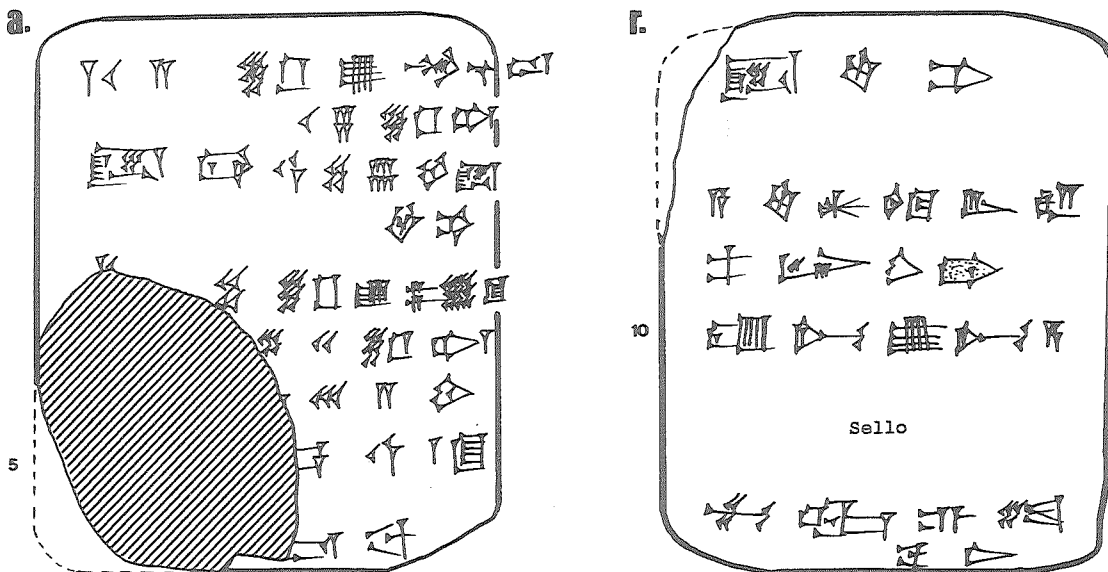

238 (MM 136)

AnOr 7 238
Umma
ŠS4/-/-

238. Sello:

Lu₂-^dTUG₂.AN-ka
dub-sar
dumu Lu₂-^dŠara₂
sa_{1,2}-du₃-ka

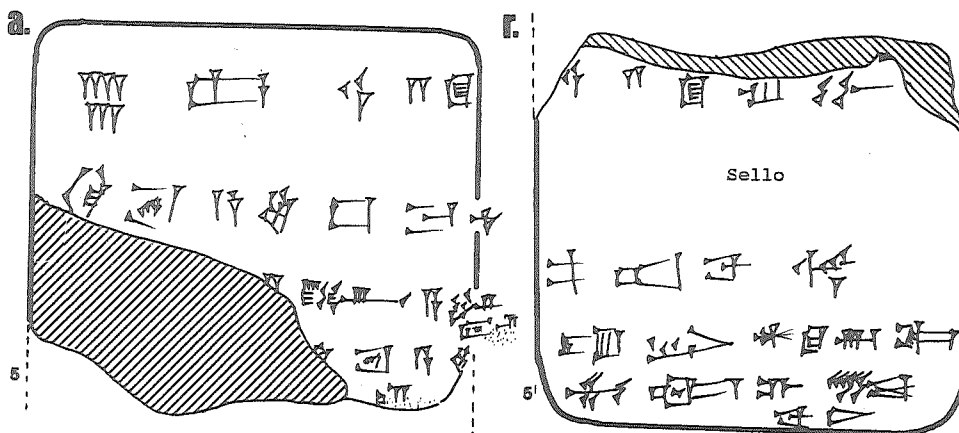

239 (MM 138)

239. Sello:

E₂-gal-e-si
dub-sar
dumu Lu₂-Šara₂
sa₂-du₅-ka

AnOr 7 239
Umma
SS4/1-

Perdido aprox. 1/3 de la tablilla (serrada con fines comerciales)

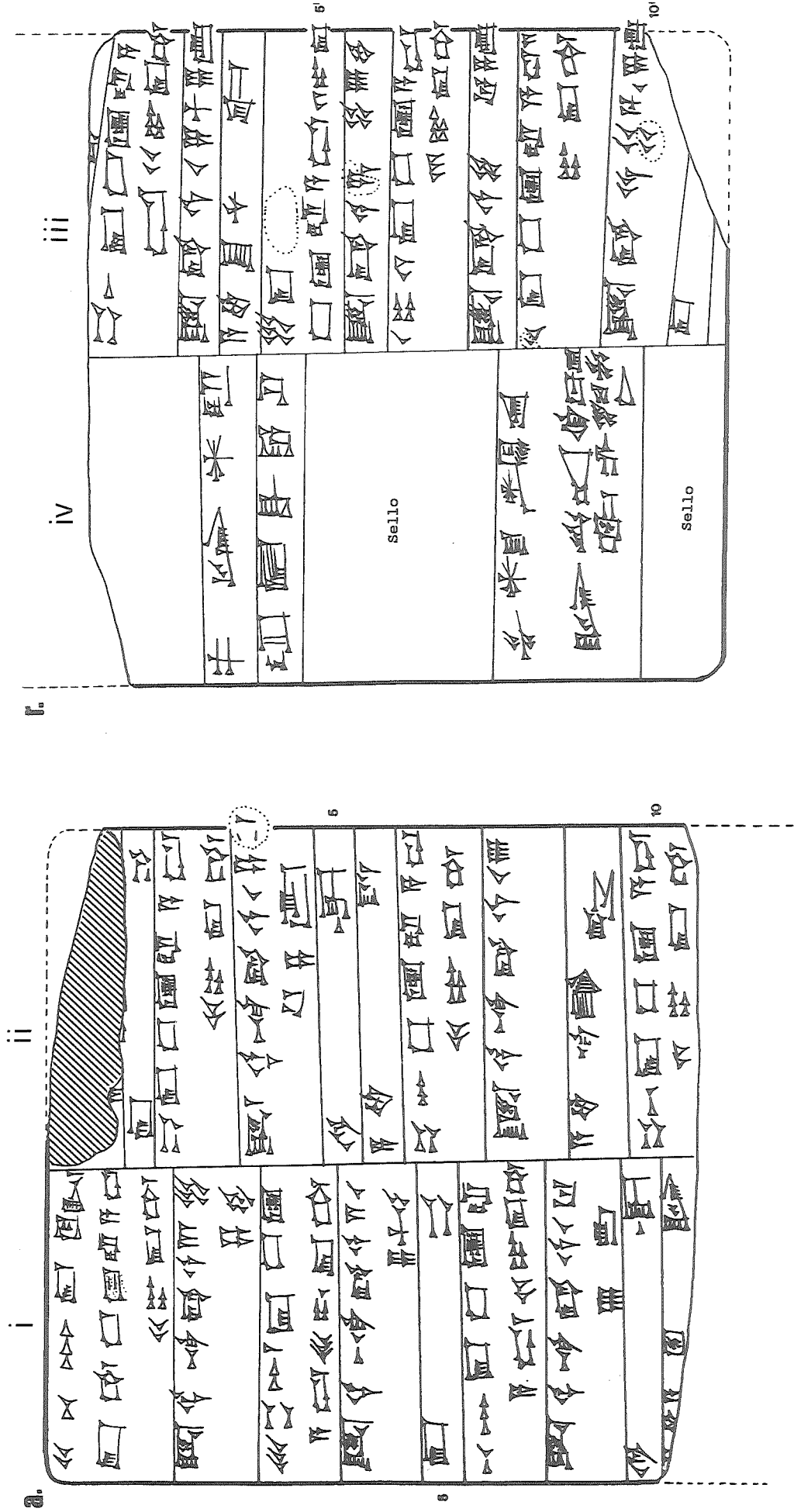

240 (MM 494)

240. Sello:

AnOr 7 240
Umma
ŠS4/-/-

Lu₂-kal-la
dub-sar
dumu Ur-e₁₁-e kuš₇

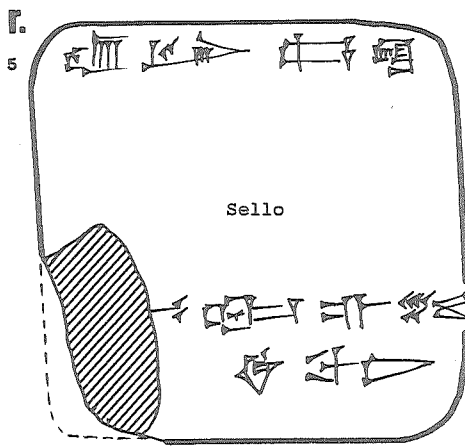
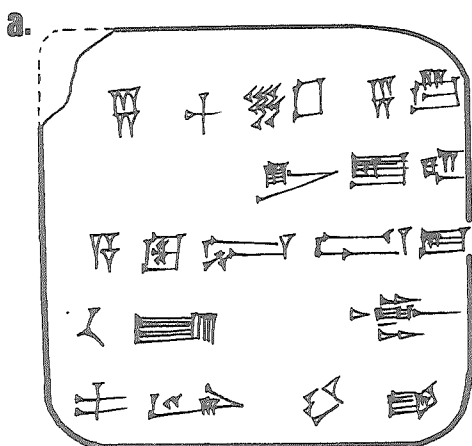

241 (MM 394)

241. Sello:

AnOr 7 241
Umma
ŠS4/viii/-

Ur-^dNun-gal
dub-sar
dumu Ur-^dŠara₂
ša₁₃-dub-ba-ka

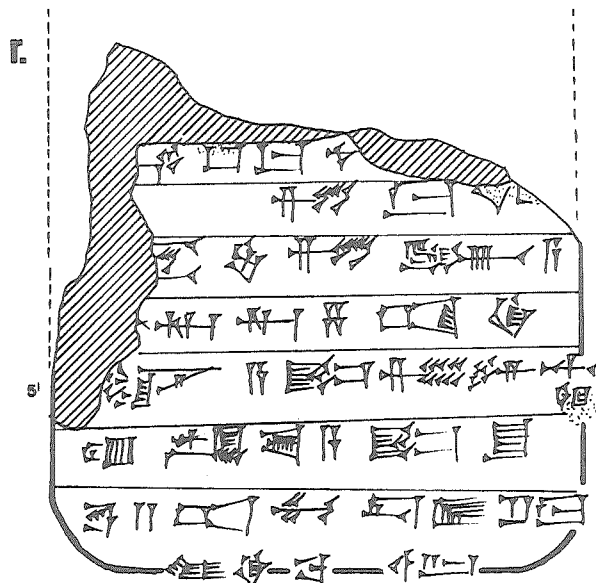
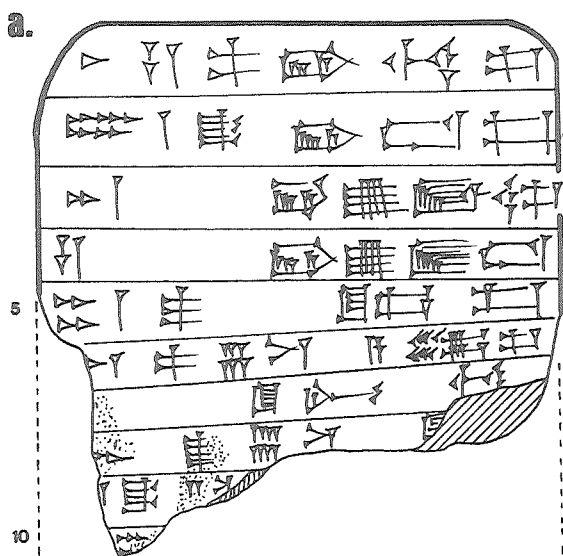

242 (MM 140)

242. Sello:

AnOr 7 242
Umma
ŠS5/vii/-

Ur-^dNin-[su]
dub-[sar]
dumu Lu₂-^d[...]

Bulla con orificios para cuerda

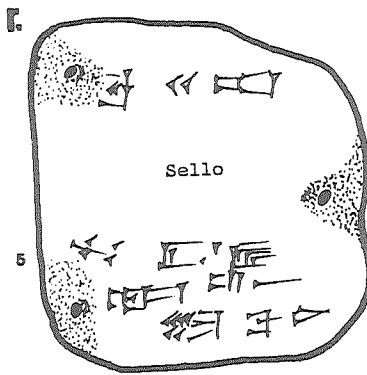
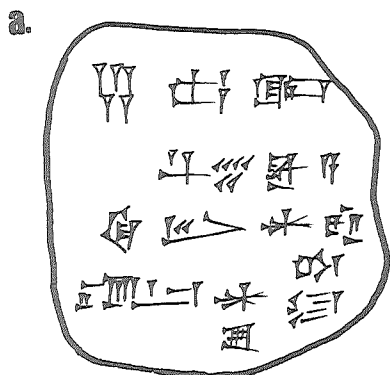

243 (MM 402)

AnOr 7 243
Umma
ŠS9/-/-

243. Sello:

Lugal-²a₂-zi-da²
dub-sar
dumu Da-[da]

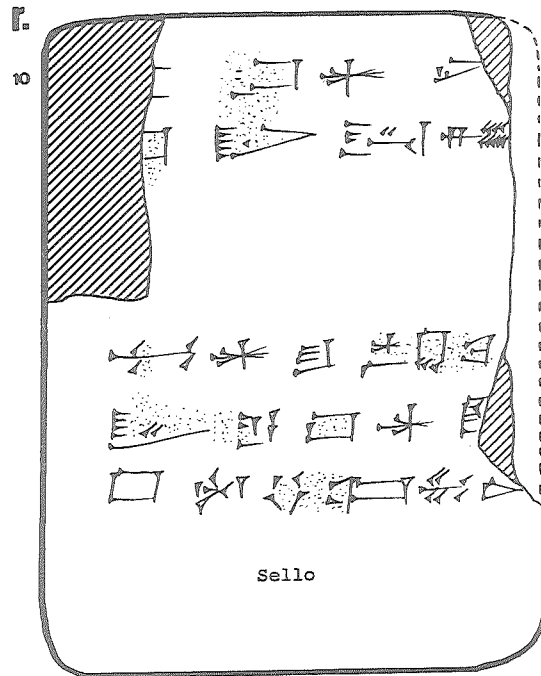
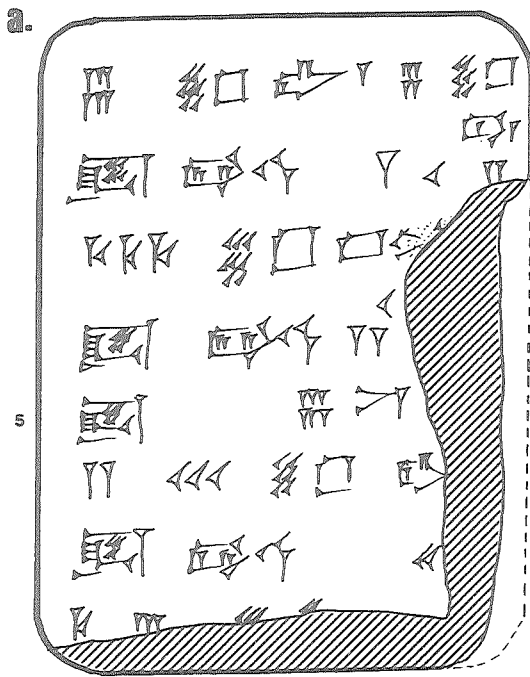

244 (MM 410)

AnOr 7 244
Umma
ŠS7/-/-

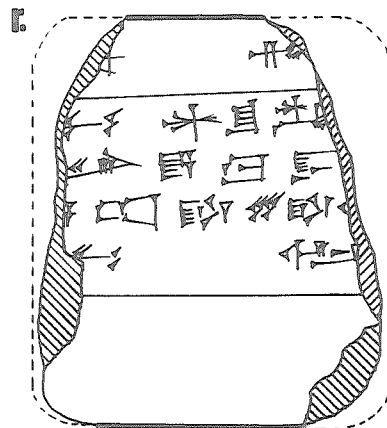
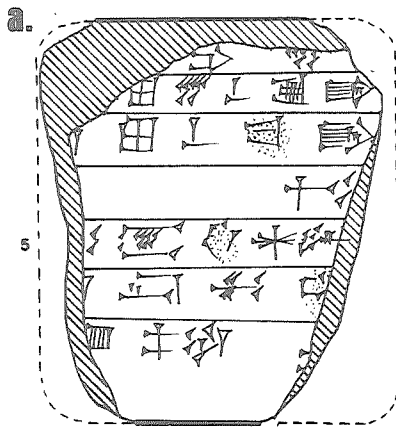

245 (MM 407)

AnOr 7 245
Umma
ŠS7/xi/-

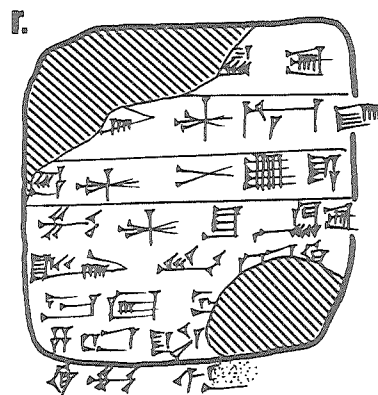

246 (MM 158)

AnOr 7 246
Umma
ŠS6 6 8/-/-

246. Sello 1:

Lu₂-kal-la
dub-sar
dumu Ur-e₁₁-[e kuš₇]

Sello 2:

Ur-^dNun-gal
dub-sar
dumu Ur-^dŠara₂
ša₁₃-dub-ba-ka

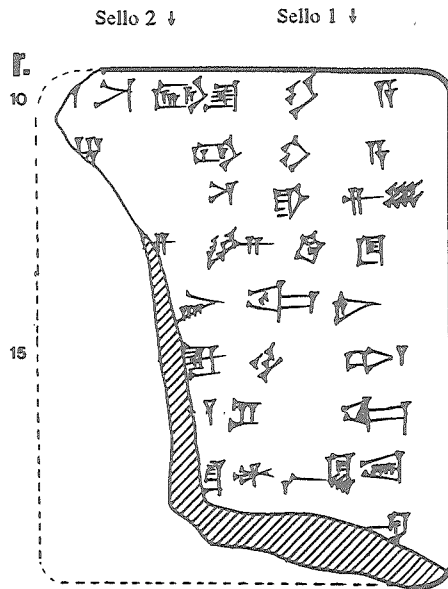
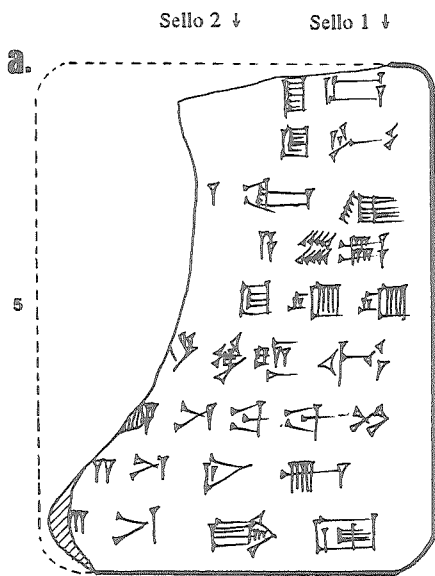

248 (MM 537)

AnOr 7 248
Umma
[]/-/-

248. Sello:

Lugal-si-NE-e
dub-sar
dumu Lugal-ša₆-ga

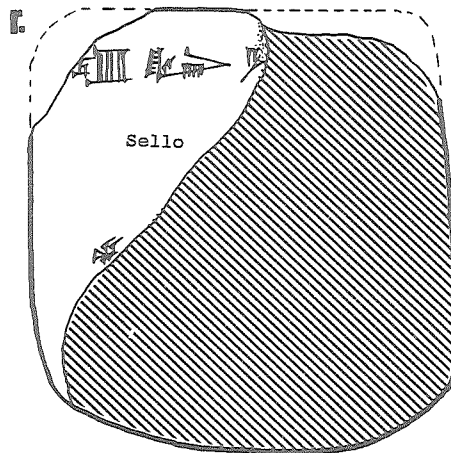
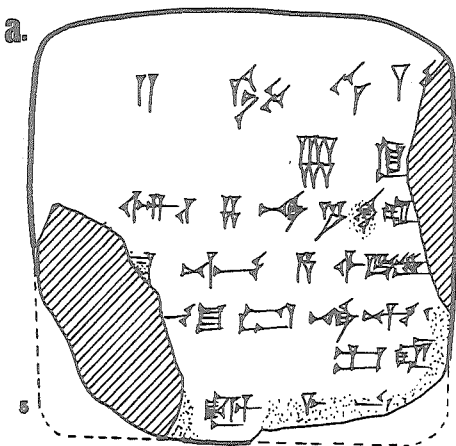

249 (MM 228)

AnOr 7 249
Umma
[]/-/-

249. Sello:

Ur-^dUtu
dumu Al-la sukkal

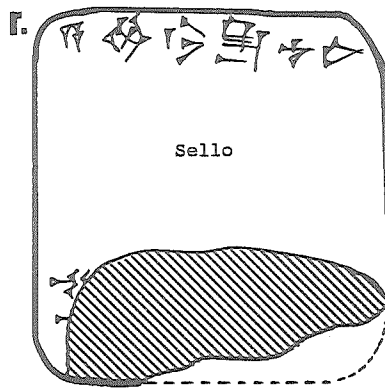
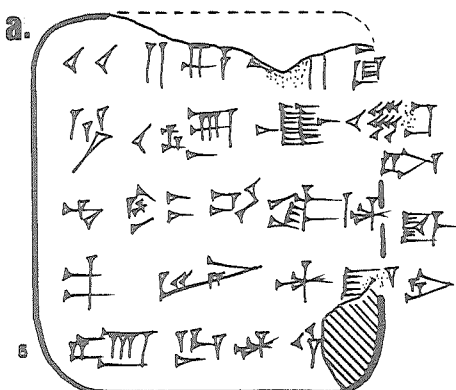

247 (MM 166+182)

AnOr 7 247 (MM 166)
Umma
IS3/-/-

247. Sello:

Lu₂-^dTUG₂.AN-ka
dub-sar
dumu Lu₂-^dSara₂
sa₁₂-du₅-ka

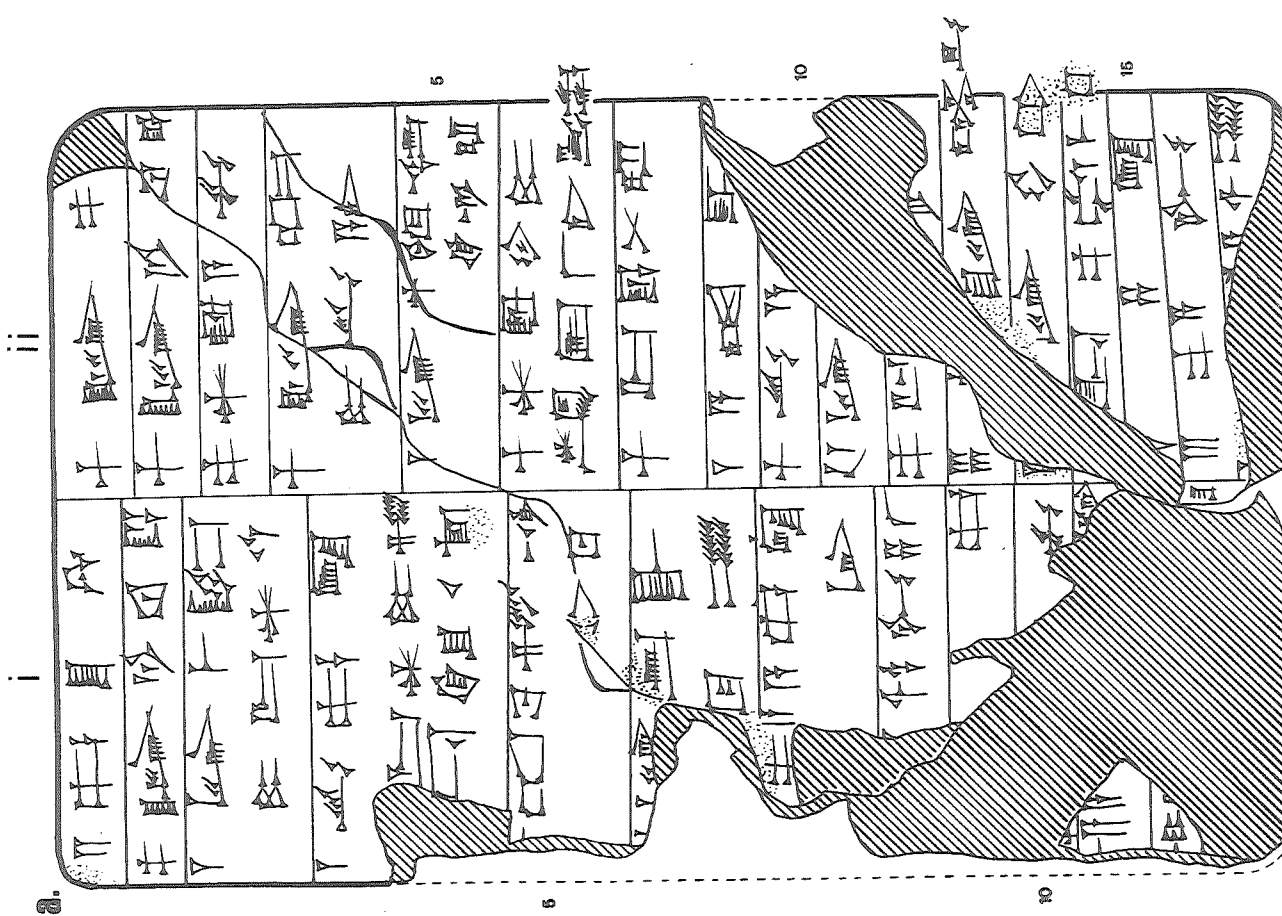
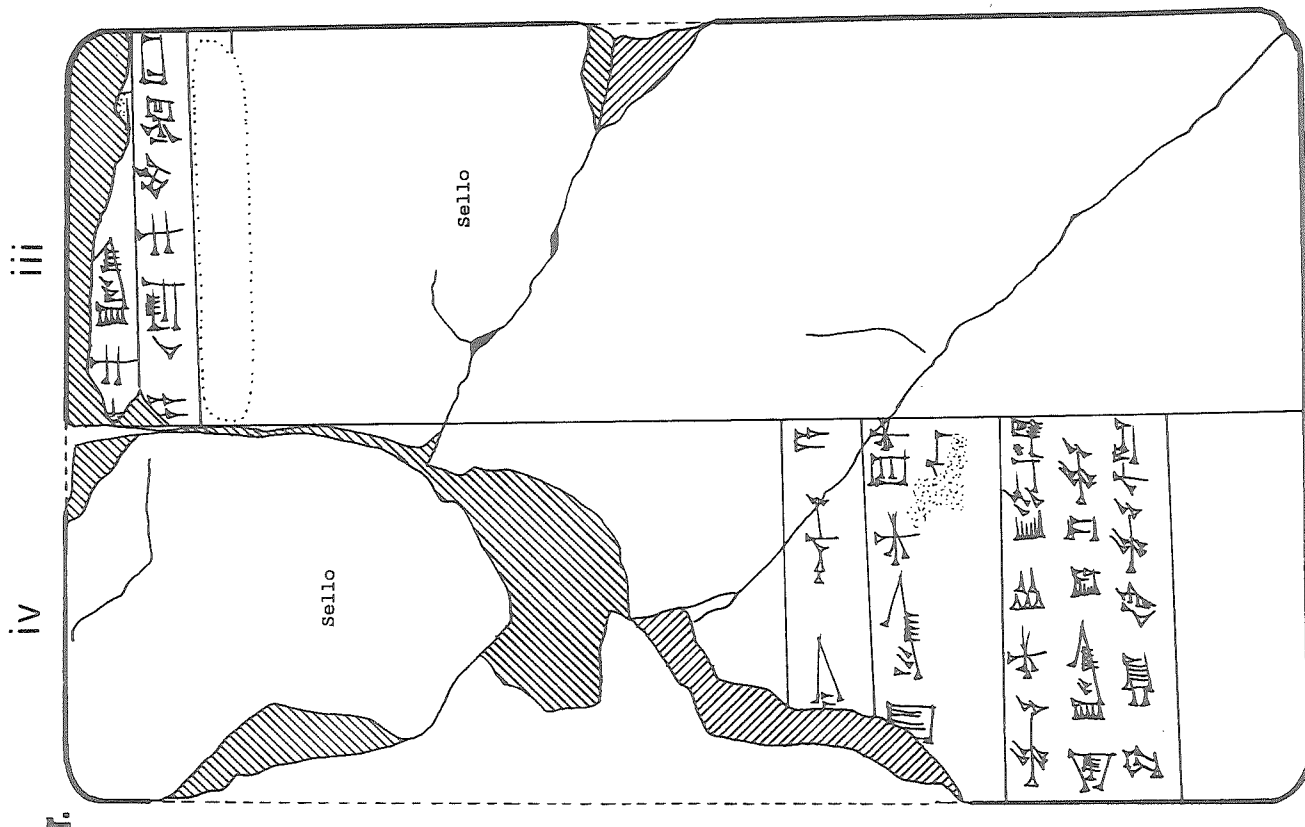

250 (MM 338)

AnOr 7 250
Umma
ŠS8/-/-

250. Sello:

Ša₃-nin-ga₂
dub-sar
dumu Lugal-nanga

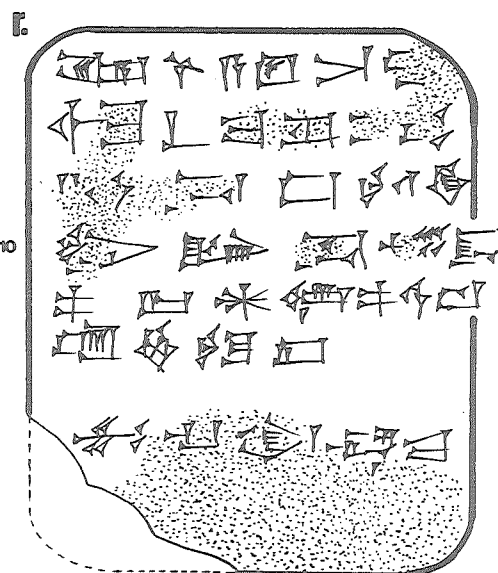
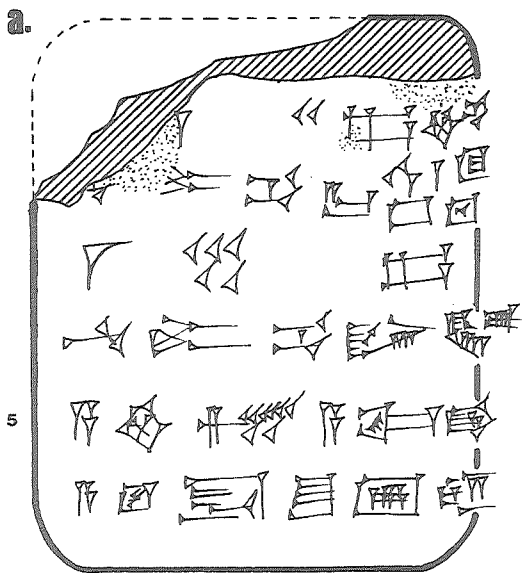

251 (MM 355)

AnOr 7 251
Umma
ŠS6 6 8/[]

251. Sello:

[L]u₂-Nin-šubur
[d]ub-sar
dumu Du₁₀-g[a]
šabra 4Šara₂-ka

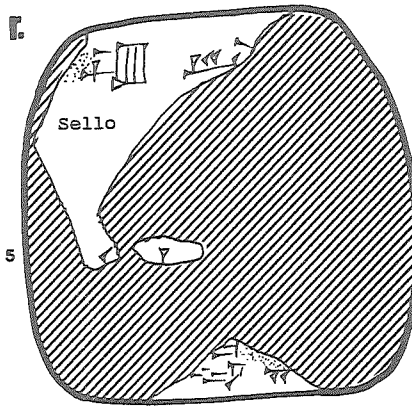
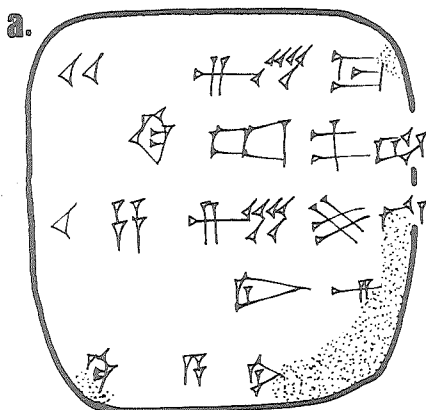

252 (MM 389)

AnOr 7 252
Umma
[]

252. Sello:

Ur-gigir
dumu A-si-[lu]

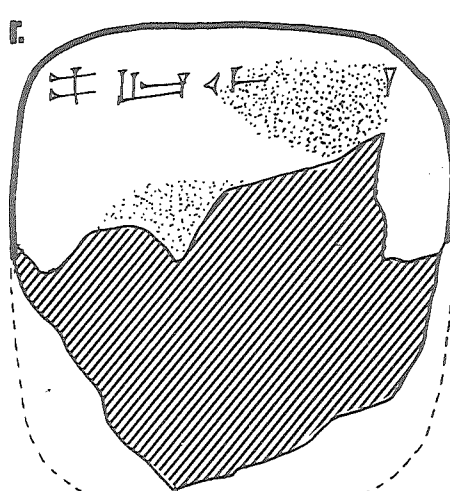
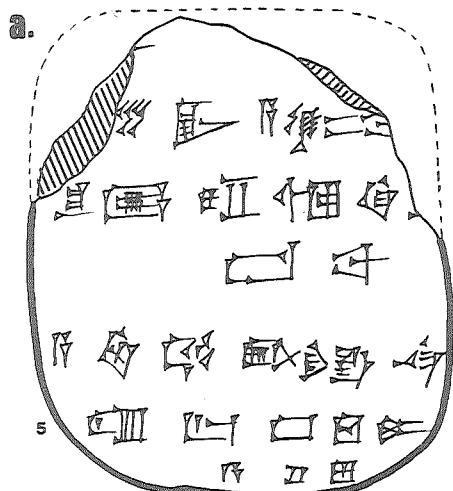

253 (MM 397)

AnOr 7 253
Umma
[]

253. Sello:

[Ba]-ša₆
dub-sar
dumu Lugal-ša₆-g[a]

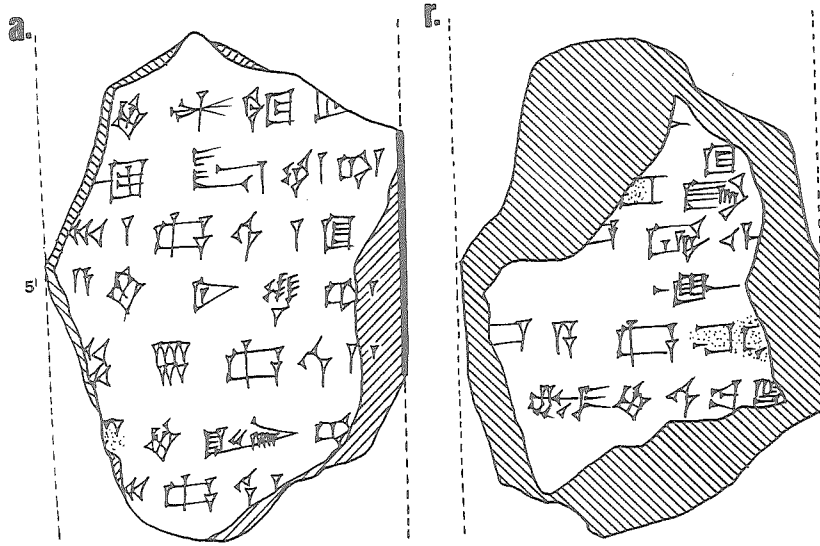

254 (MM 406)

AnOr 7 254
Umma
[]

254. Sello:

A-lu₅-lu₃
dumu Inim-⁴Šara₂
kurušda ⁴Šara₂-ka

Reverso anepigráfico sellado y borde inferior destruido

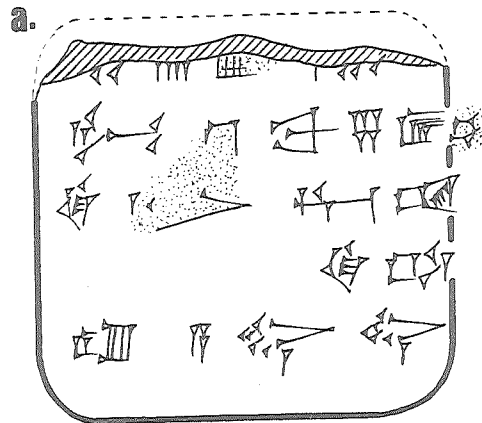

255 (MM 435)

AnOr 7 255
Umma
AS1 ŠS1 6 IS1/[]

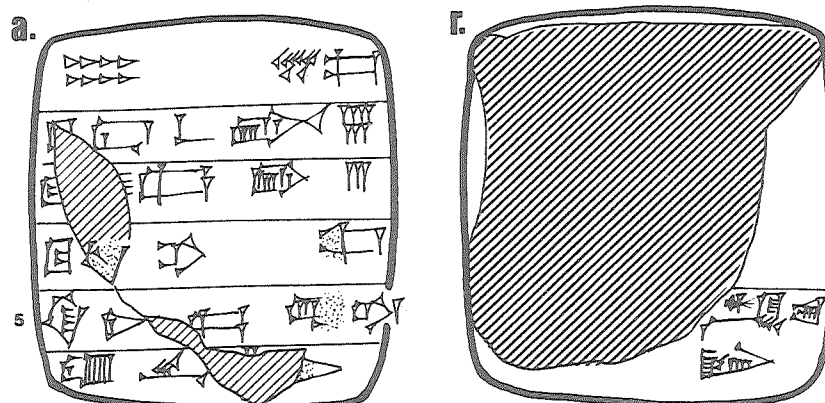

256 (MM 161)

AnOr 7 256
Umma
IS1/-/-

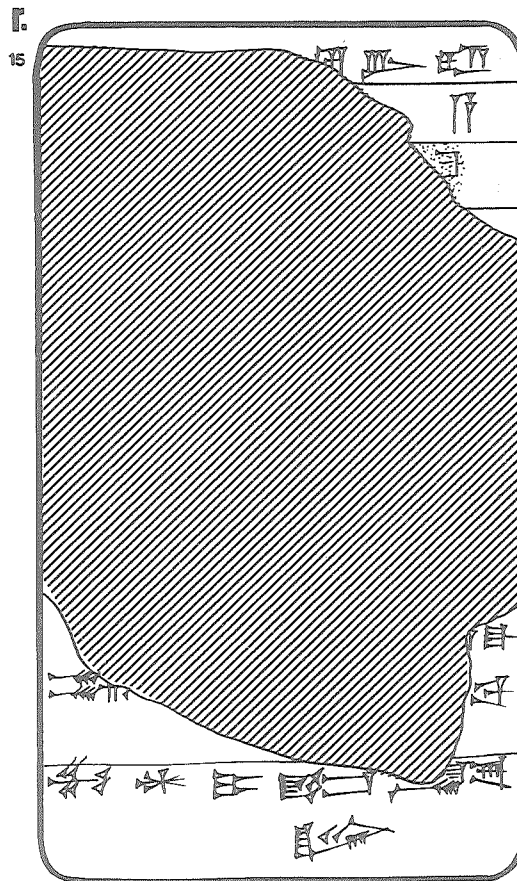
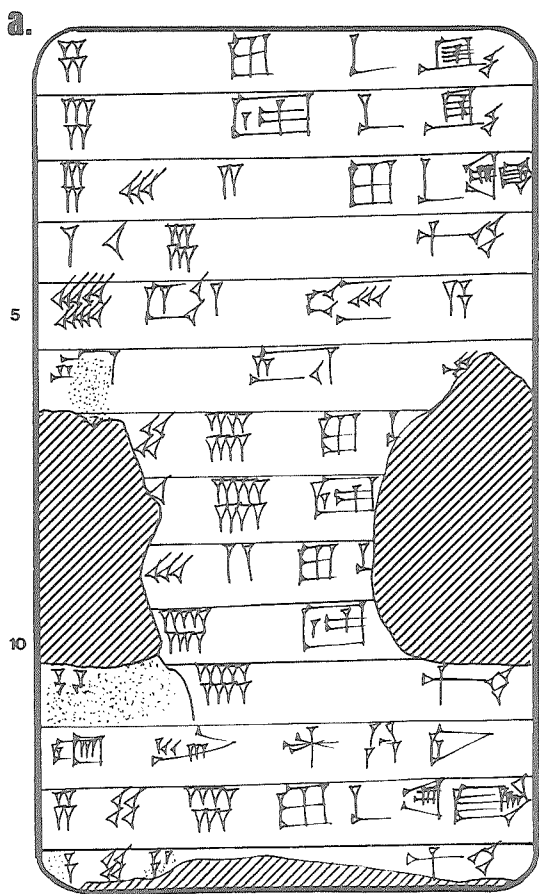

257 (MM 356)

AnOr 7 257
Drehem?
Š47 6 48/i/15

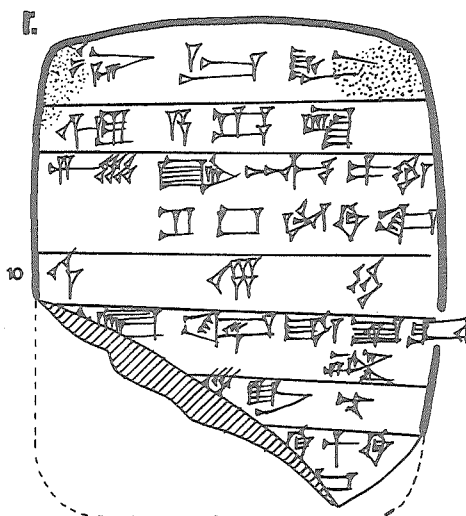
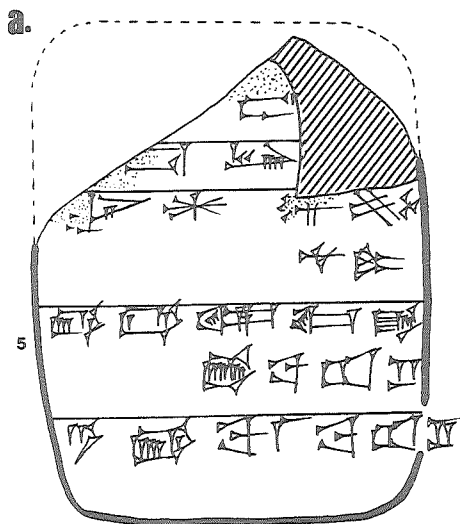

258 (MM 578)

AnOr 7 258
Lagaš
[]/xiii/-

Perdida aprox. media tablilla

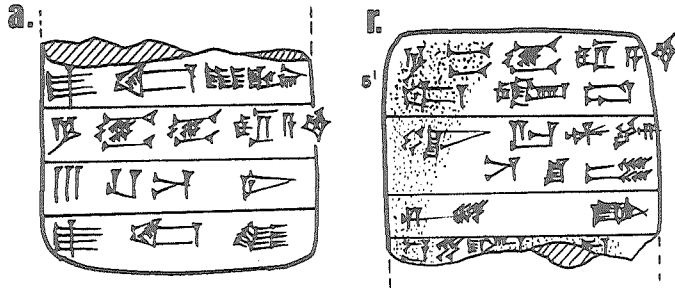

259 (MM 499)

AnOr 7 259
Umma
AS8/- {AS5-8}

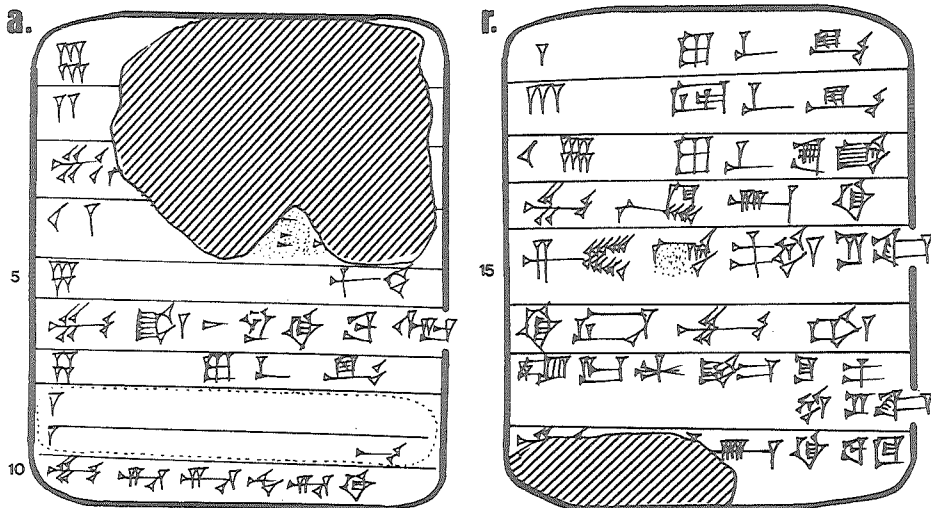

260 (MM 373)

AnOr 7 260
Umma
ŠS4/[] {ŠS3}

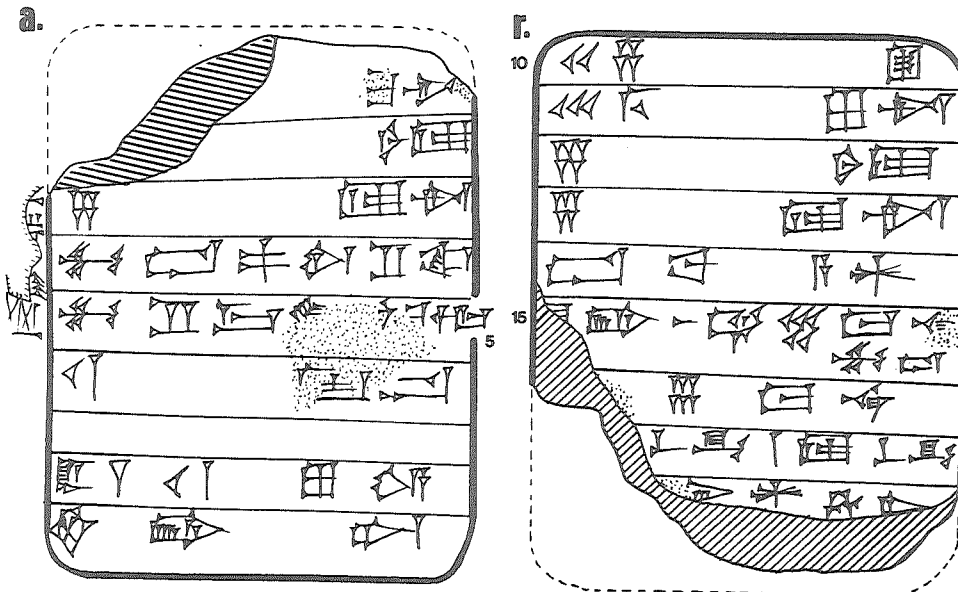

261 (MM 453)

AnOr 7 261
Umma
-viii/-

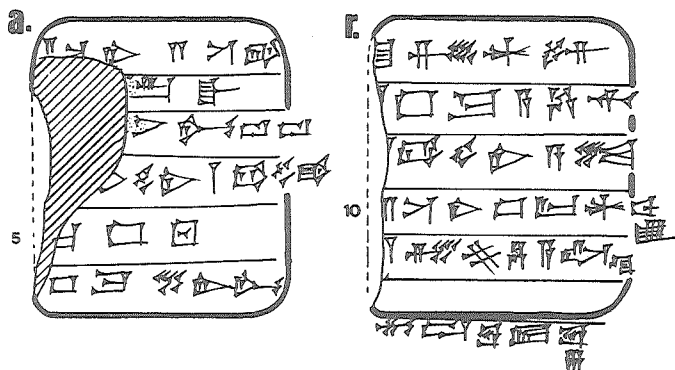

263 (MM 519)

AnOr 7 263
Umma
ŠS1-3/-

263. Sello:

Lu₂-^dTUG₂.AN-ka
dub-sar
dumu Lu₂-^dŠara₂
sa₁₂-du₅-ka

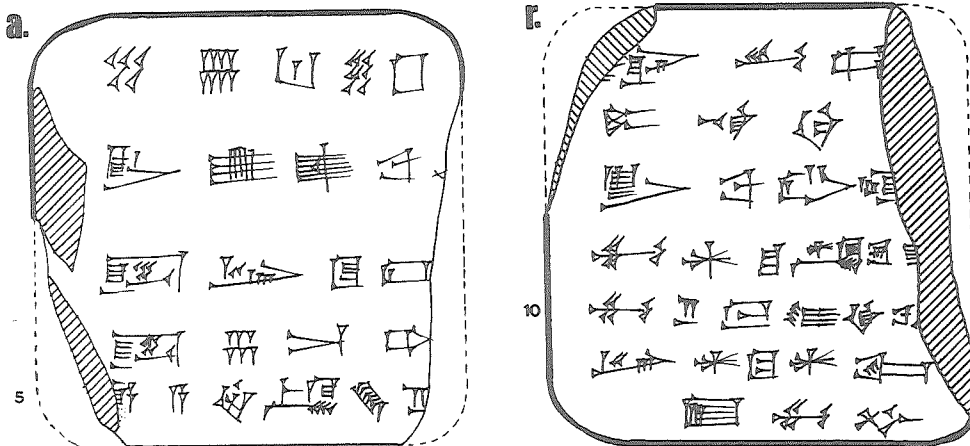

265 (MM 354)

AnOr 7 265
Umma
AS7/vii/-

265. Sello:

Lugal-^e₂-mah-e²
dub-sar
dumu Inim-^dŠara₂
sa₁₂-du₅-ka

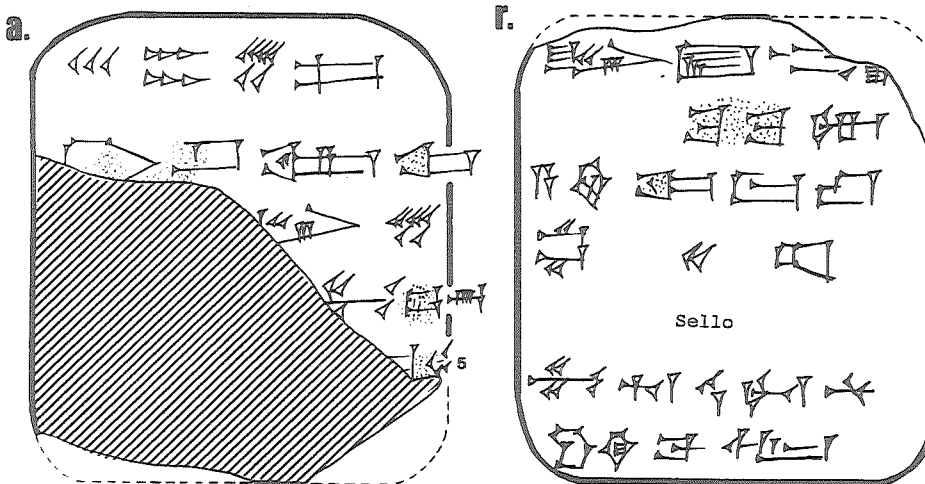

262 (MM 130)

AnOr. 7 262
Umma
SS2/iii-

Perdido aprox. 1/3 de la tablilla

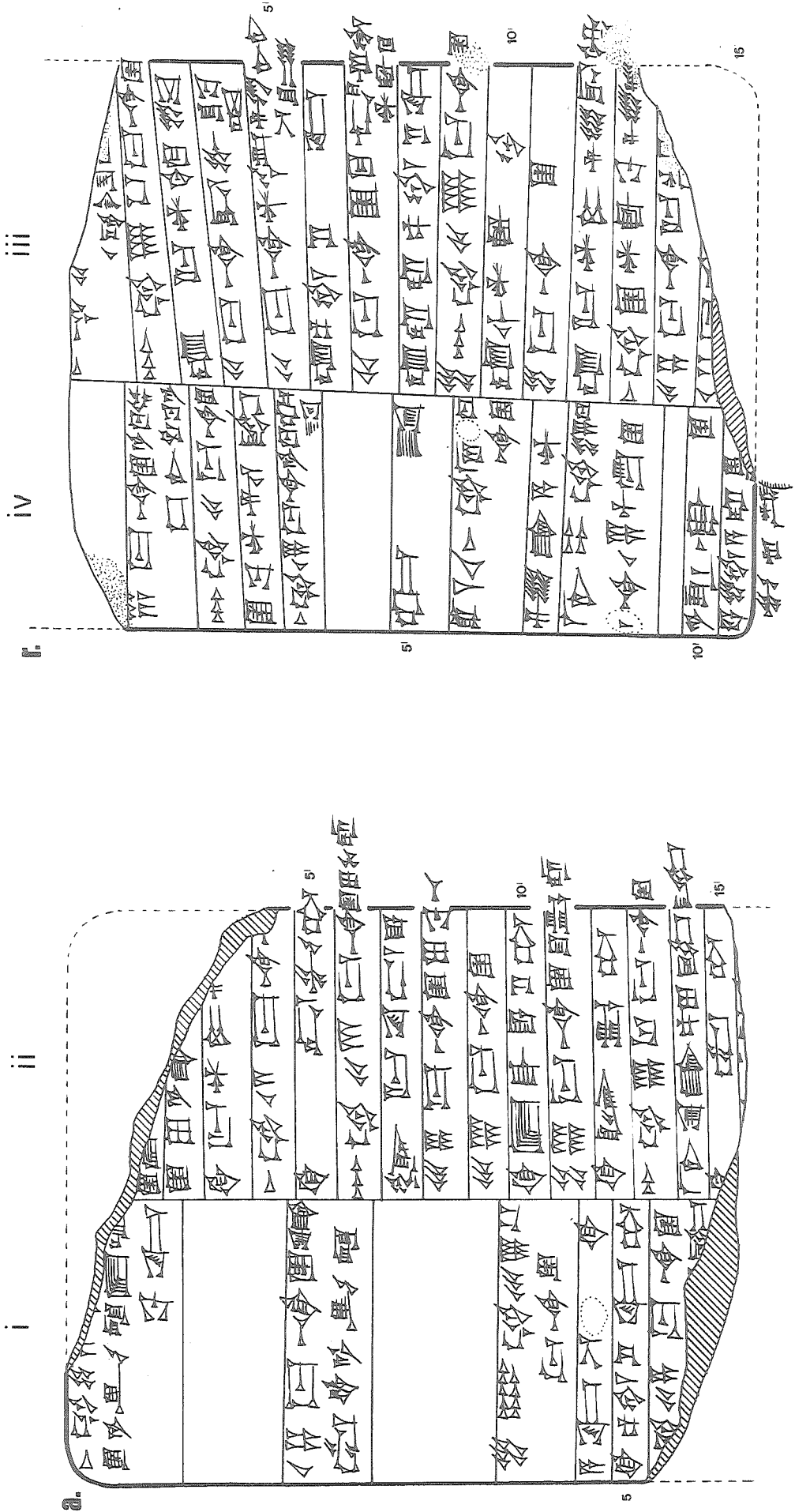

264 (MM 171)

Deimel OrSP 2 (1920) 56
AnOr 7 264
Umma
[]

Perdido aprox. 3/4 de la tablilla
(serrada con fines comerciales)
Col.vi escrita en seco

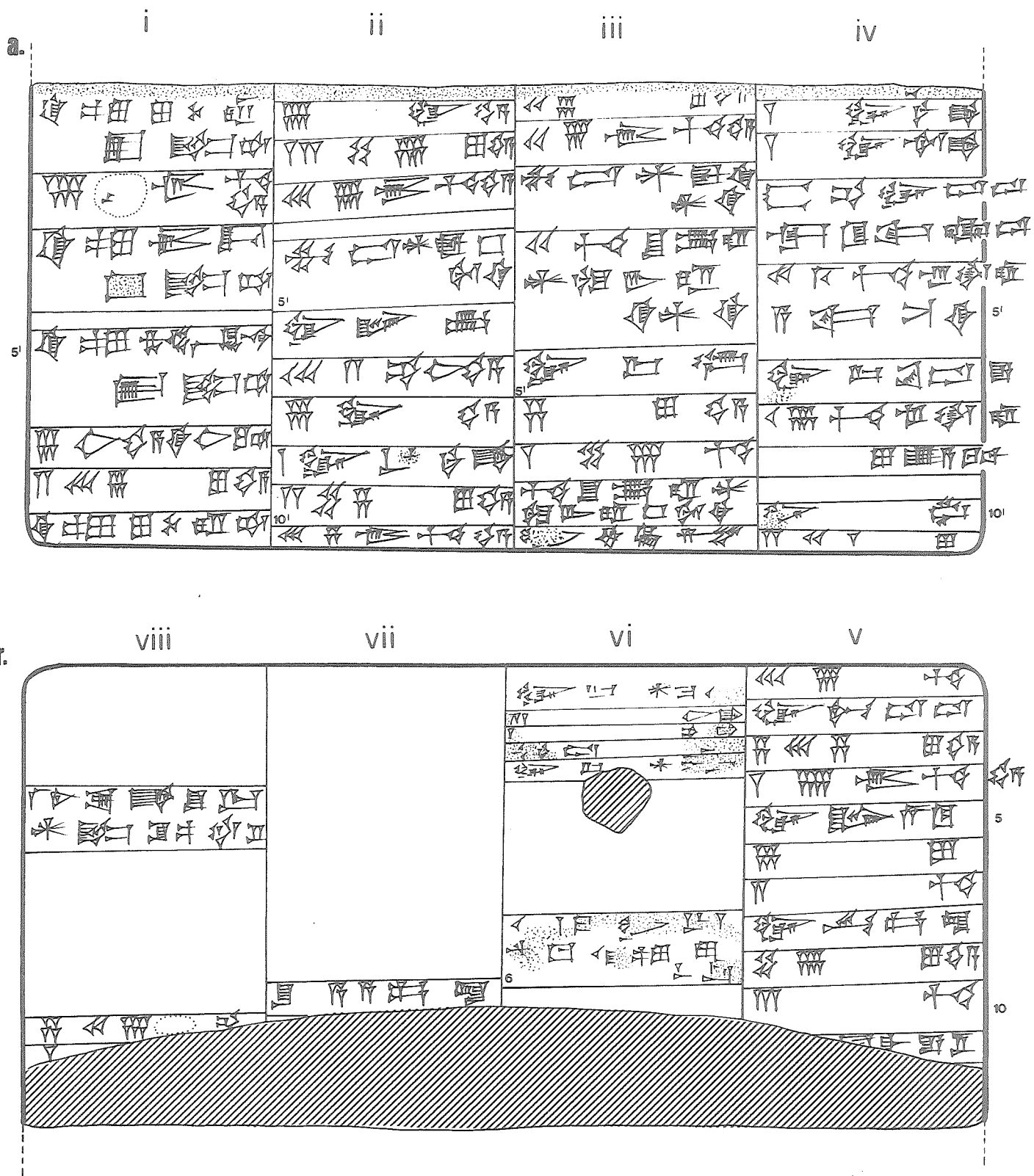

266 (MM 579)

AnOr 7 266
 Umma
 Š48/ix/-

266. Sello:

Lugal-nes[ag₂-e]
 dumu Lu₂-[...]

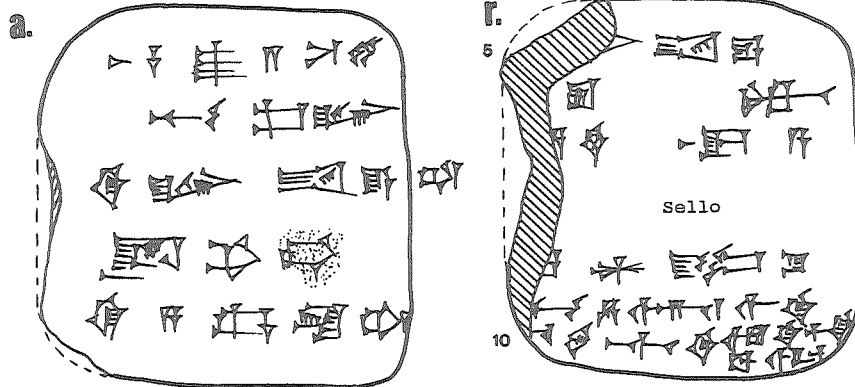

267 (MM 224)

AnOr 7 267
 Umma
 Š36/-/-

267. Sello:

Da-da-a
 dub-sar

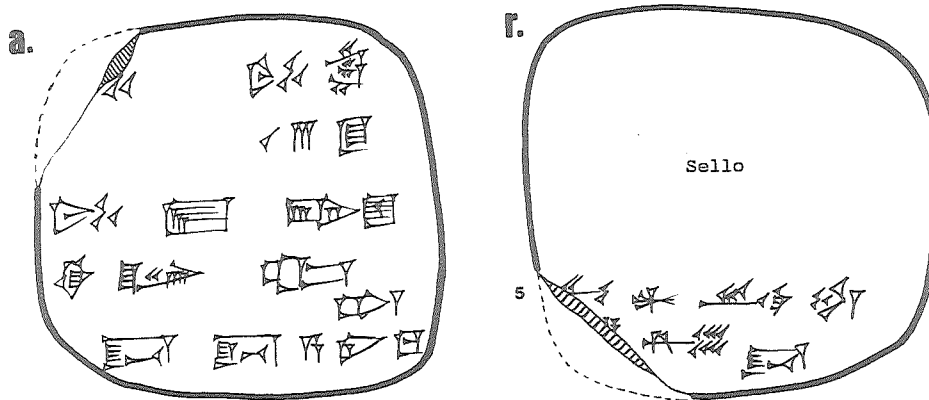

268 (MM 357)

AnOr 7 268
 Umma
 AS1/vii/-

268. Sello:

Ur-ama-na
 dub-sar
 dumu Ur-^{eb}gigir 'ša₃-tam'

Reverso anepigráfico sellado

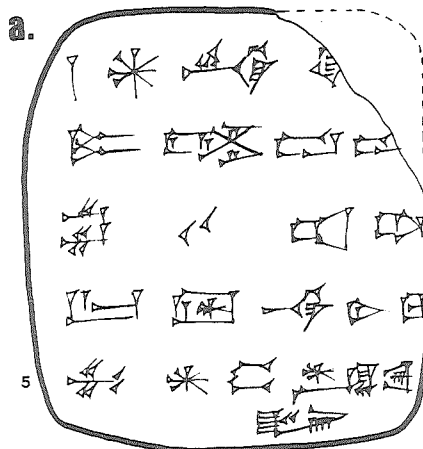

269 (MM 416)

AnOr 7 269
Umma
ŠS2/-/- {v}

269. Sello:

Ur-[...]
dub-^r sar^r
dumu Š^r.A^r.AN^r

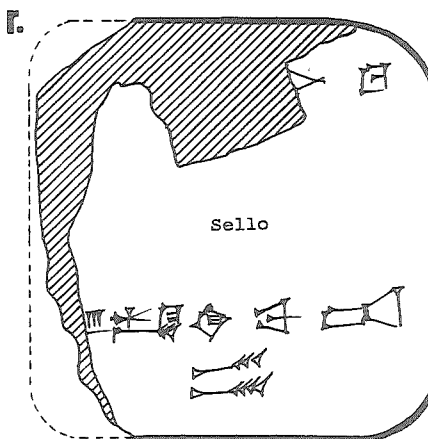
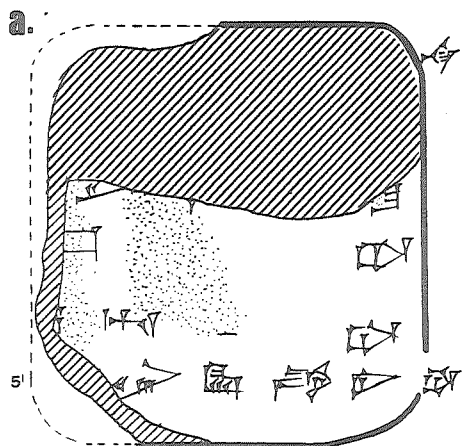

270 (MM 378)

AnOr 7 270
Umma
ŠS8/-/-

270. Sello:

Ša₃-nin-ga₂
dub-sar
dumu Lugal-nanga

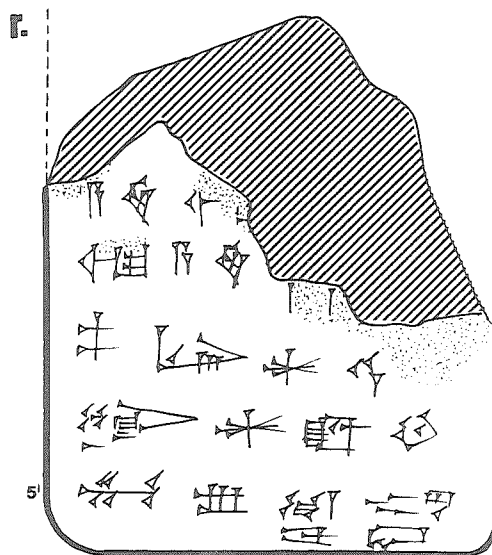
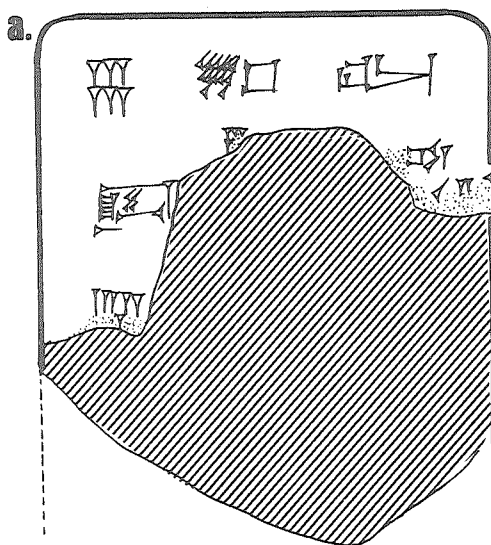

271 (MM 420)

AnOr 7 271
Drehem'
{ }/viii ó ix/-

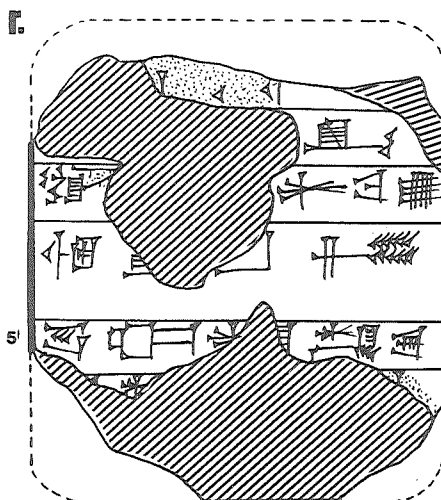
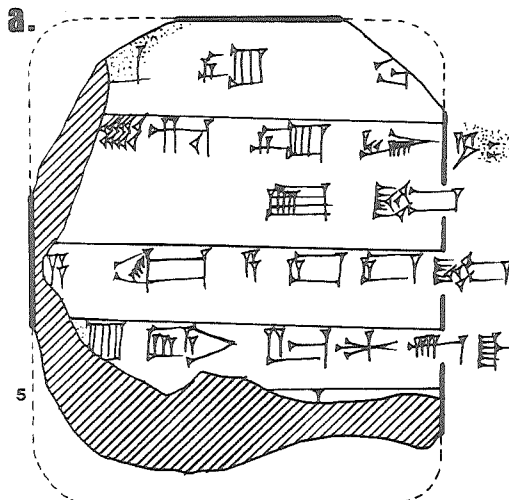

272 (MM 573)

AnOr 7 272
Umma
Š33/iv ó vi/-

272. Sello:

Arad₂-[mu]
dub-[sar]
dumu Ur-n[i₉-gar kuš₇]

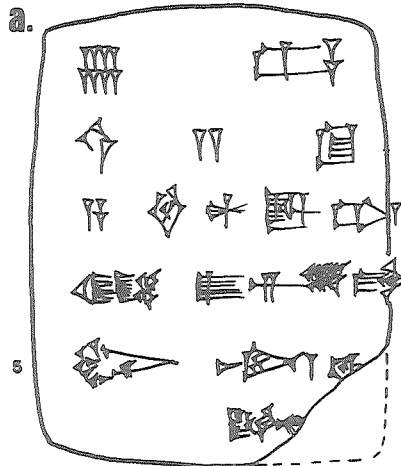

273 (MM 116)

AnOr 7 273
Umma
AS6/-/-

273. Sello:

Gu₄-TAR
"arad" Inanna Unu^{ki}

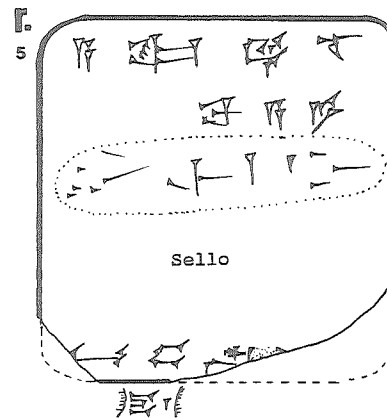
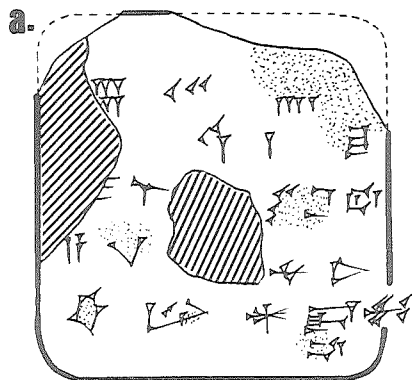

274 (MM 461)

AnOr 7 274
Umma
Š33/-/-

274. Sello:

Ur⁴-Nun-gal
dub-sar
dumu Ur⁴-Šara₂
ša₁₃-dub-ba-ka

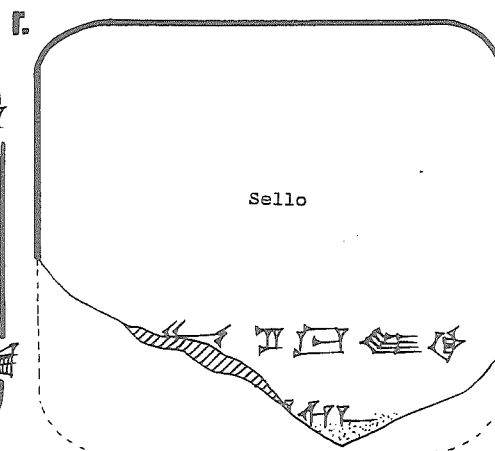
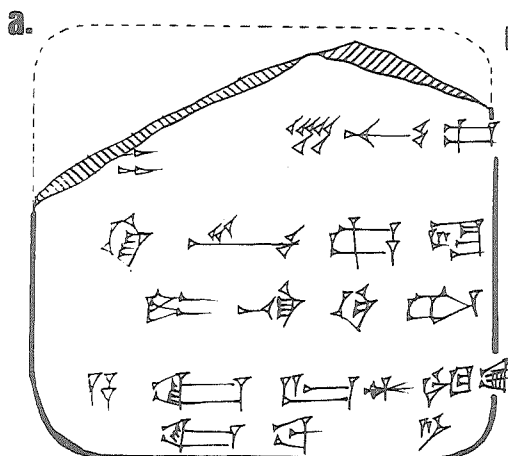

275 (MM 384)

AnOr 7 275
Umma
ŠS1/vi/30

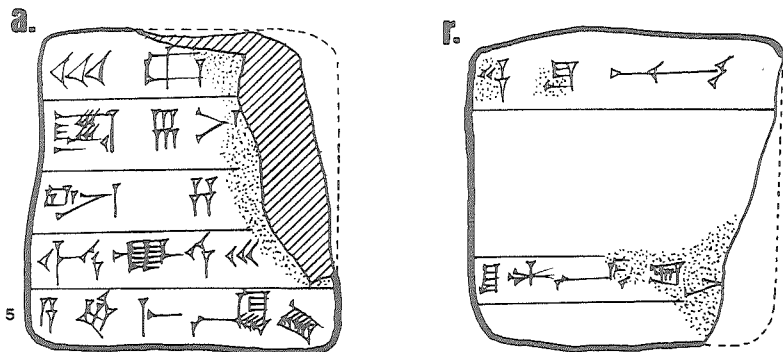

276 (MM 424)

AnOr 7 276
Umma
AS2/ii/8

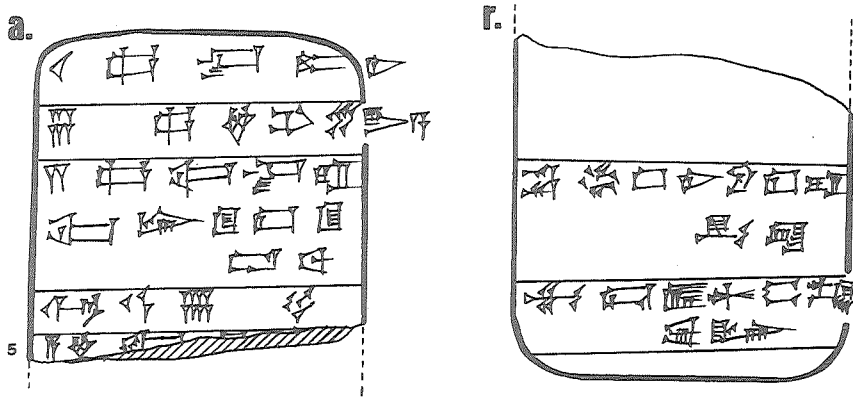

277 (MM 336)

AnOr 7 277
Umma
ŠS1/- (i-ix)

277. Sello:

Ur-Šara₂
dub-sar
dumu Šes-kal-la

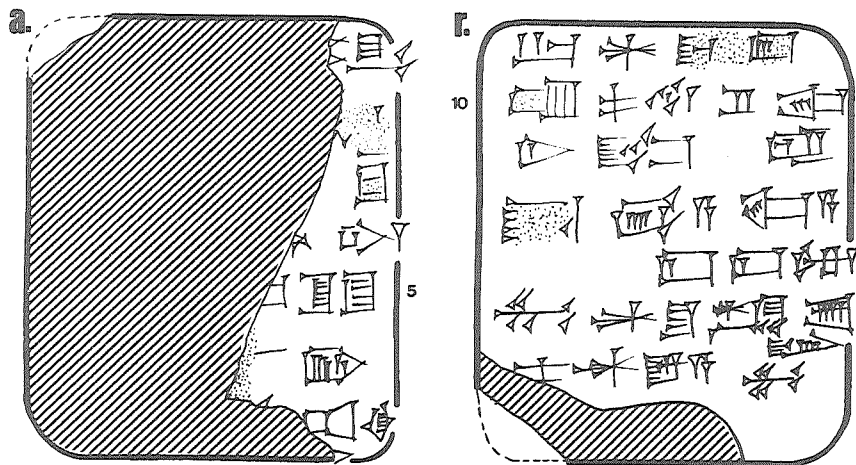

278 (MM 345)

AnOr 7 278
?
-/-

Anverso destruido

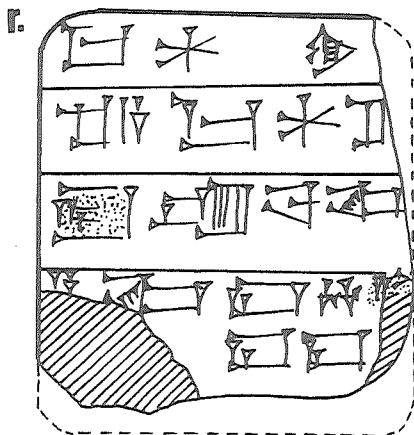

279 (MM 569)

AnOr 7 279
Umma
ŠS3/ii/-

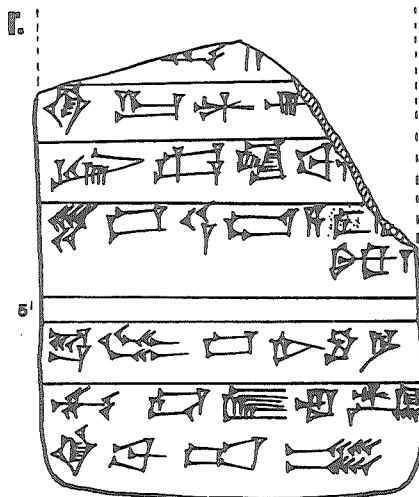
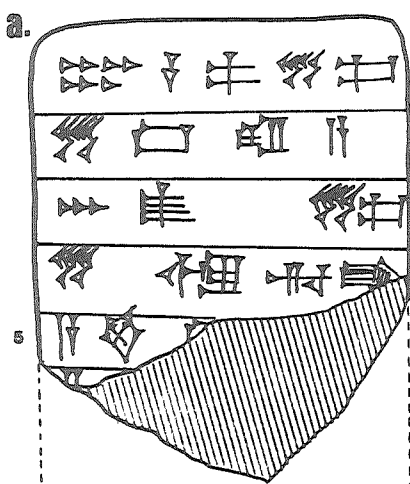

280 (MM 517)

AnOr 7 280
Umma
Š47/x/-

Perdida aprox. media tablilla

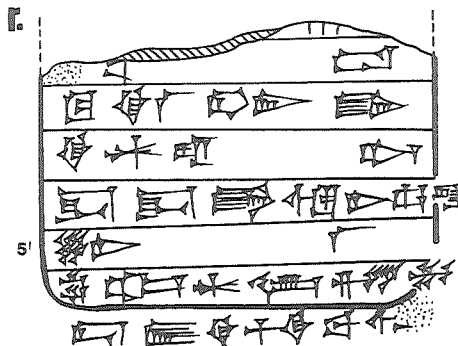
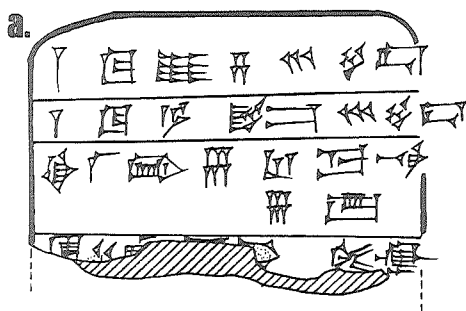

281 (MM 588)

AnOr 7 281
Umma
[]

Perdida aprox. media tablilla

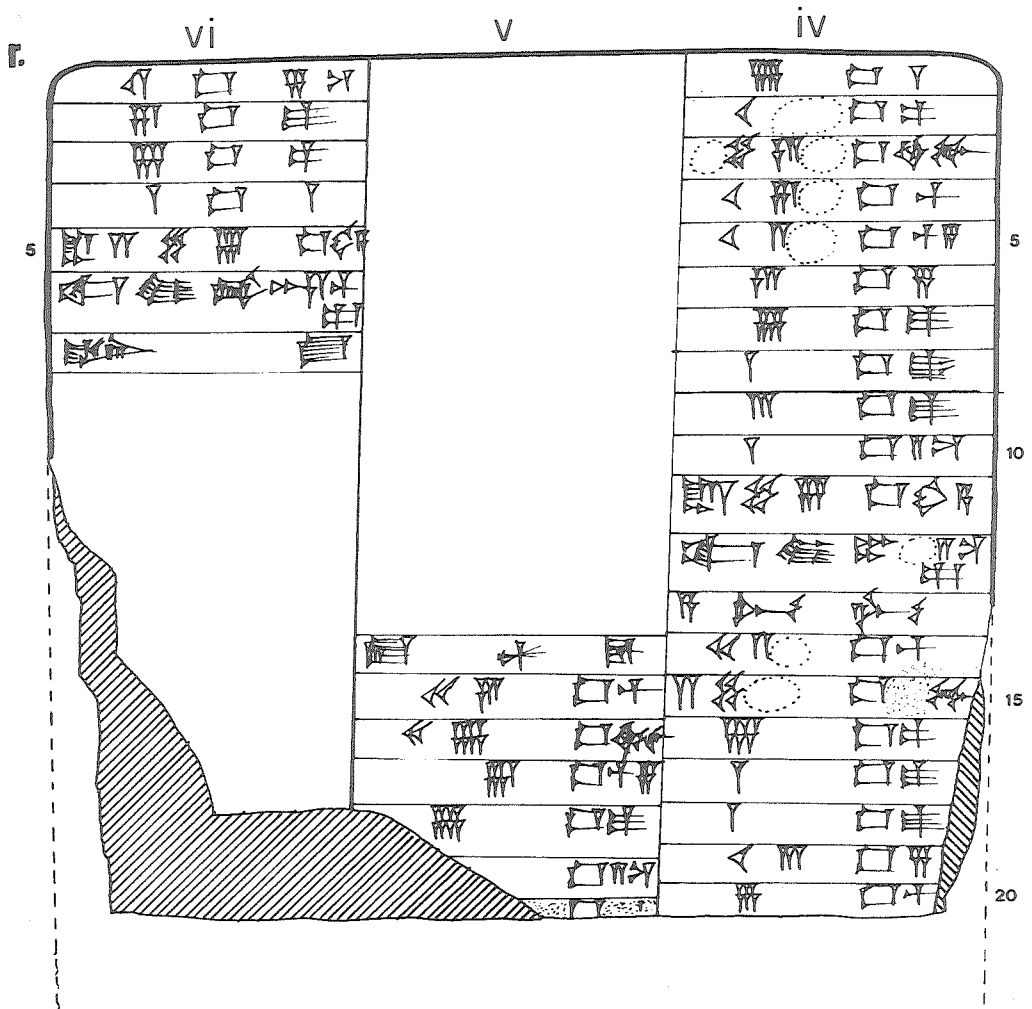
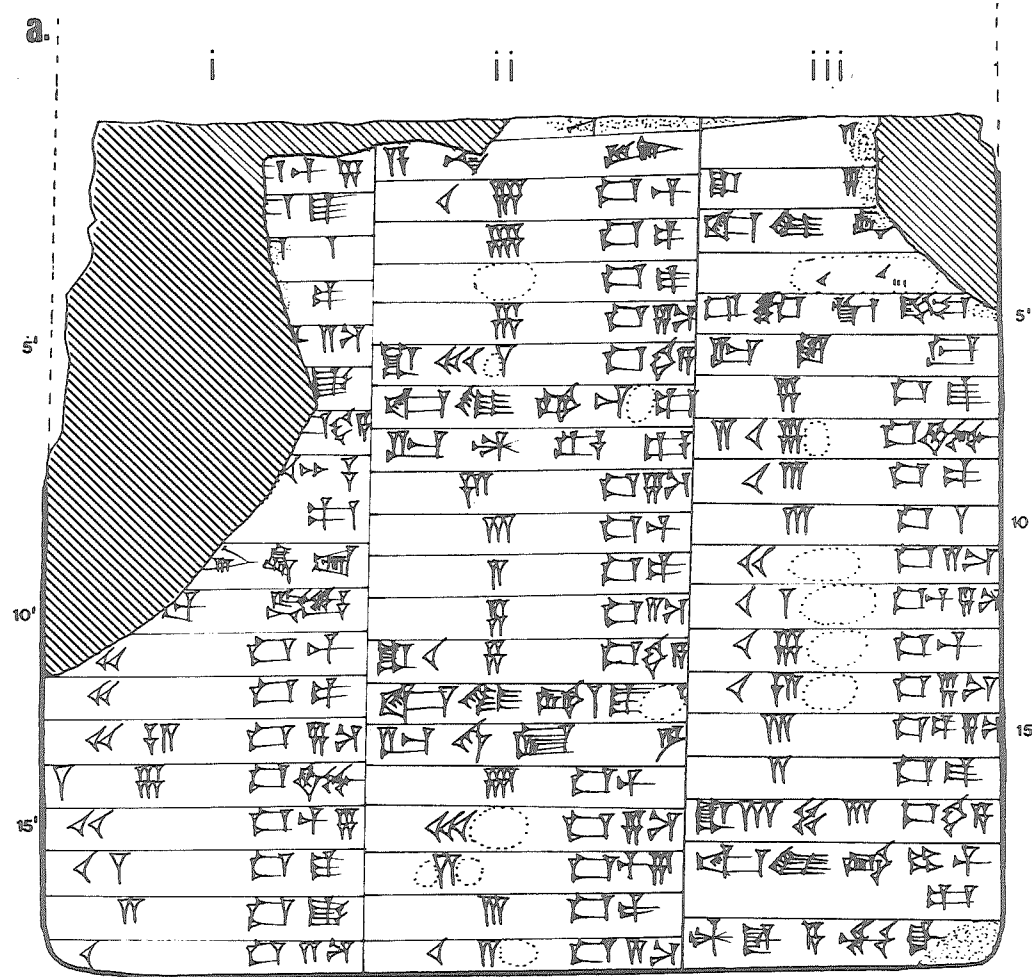

AnOr 7 282
Umma
Š45 46 AS2 6 3/-

Perdida aprox. media tablilla.

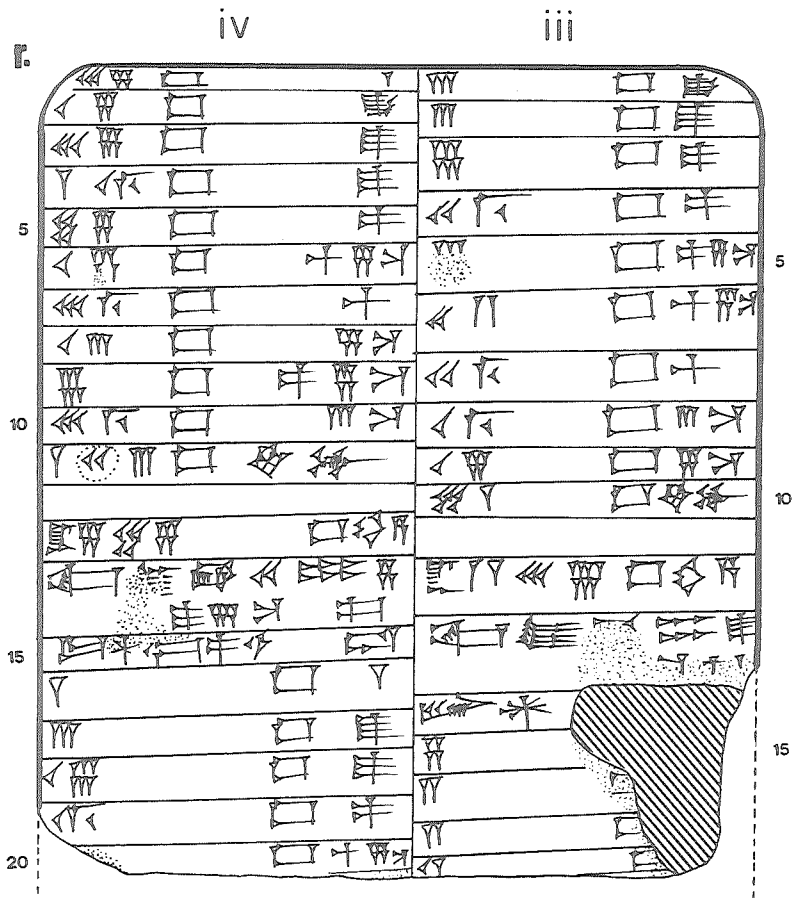
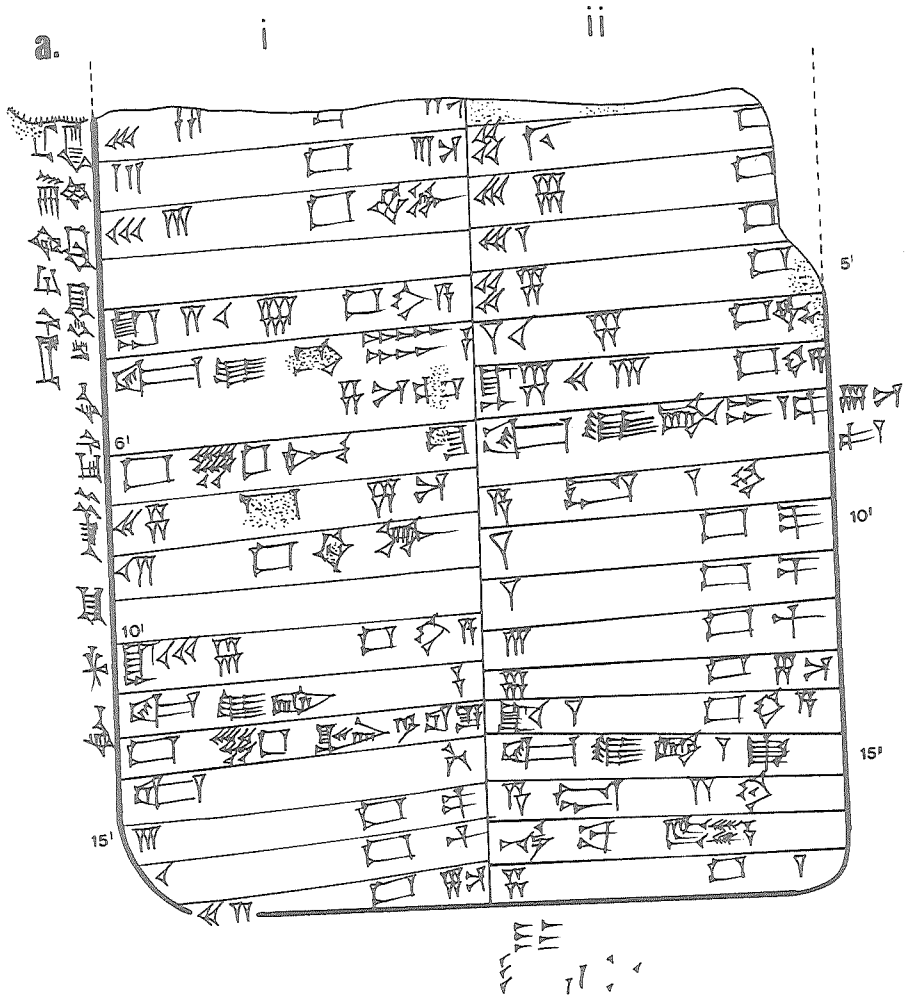

283 (MM 179)

283. Sello:

AnOr 7 283
Umma
[]

Ur-e₂-mah
dub-sar
dumu Lugal-k[u₃-ga-ni]

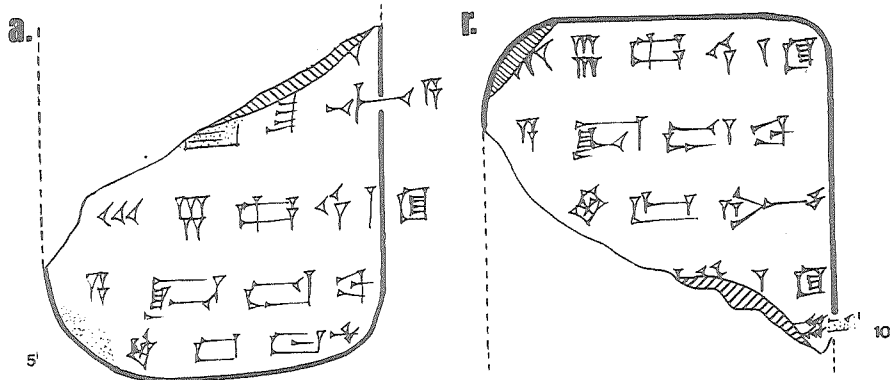

284 (MM 184)

Perdido aprox. 2/3 de la tablilla
(serrada con fines comerciales)

AnOr 7 284
Umma
[]

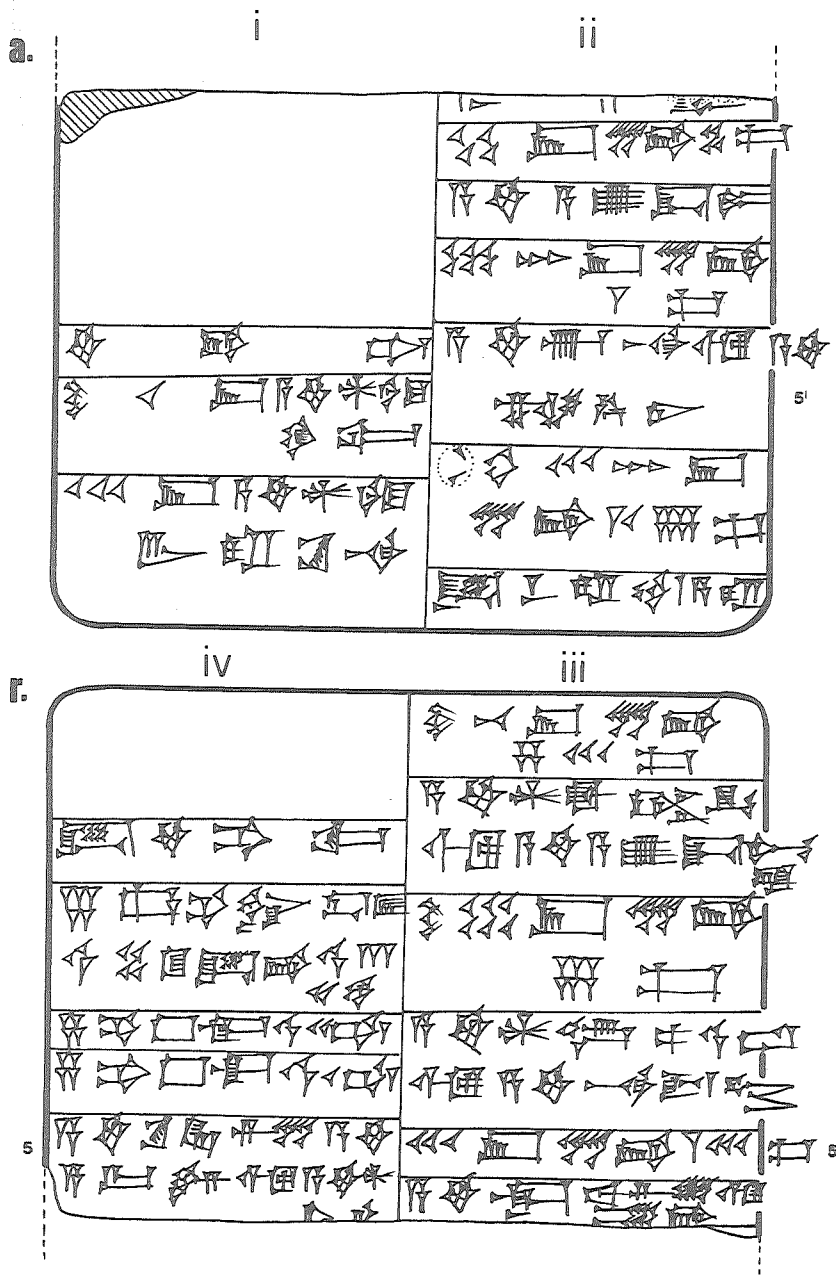

285 (MM 188)

AnOr 7 285
Lagaš⁷
[]

Medidas originales aprox. 240 x 190 mm y seis columnas por cada cara (serrada por los cuatro lados con fines comerciales)

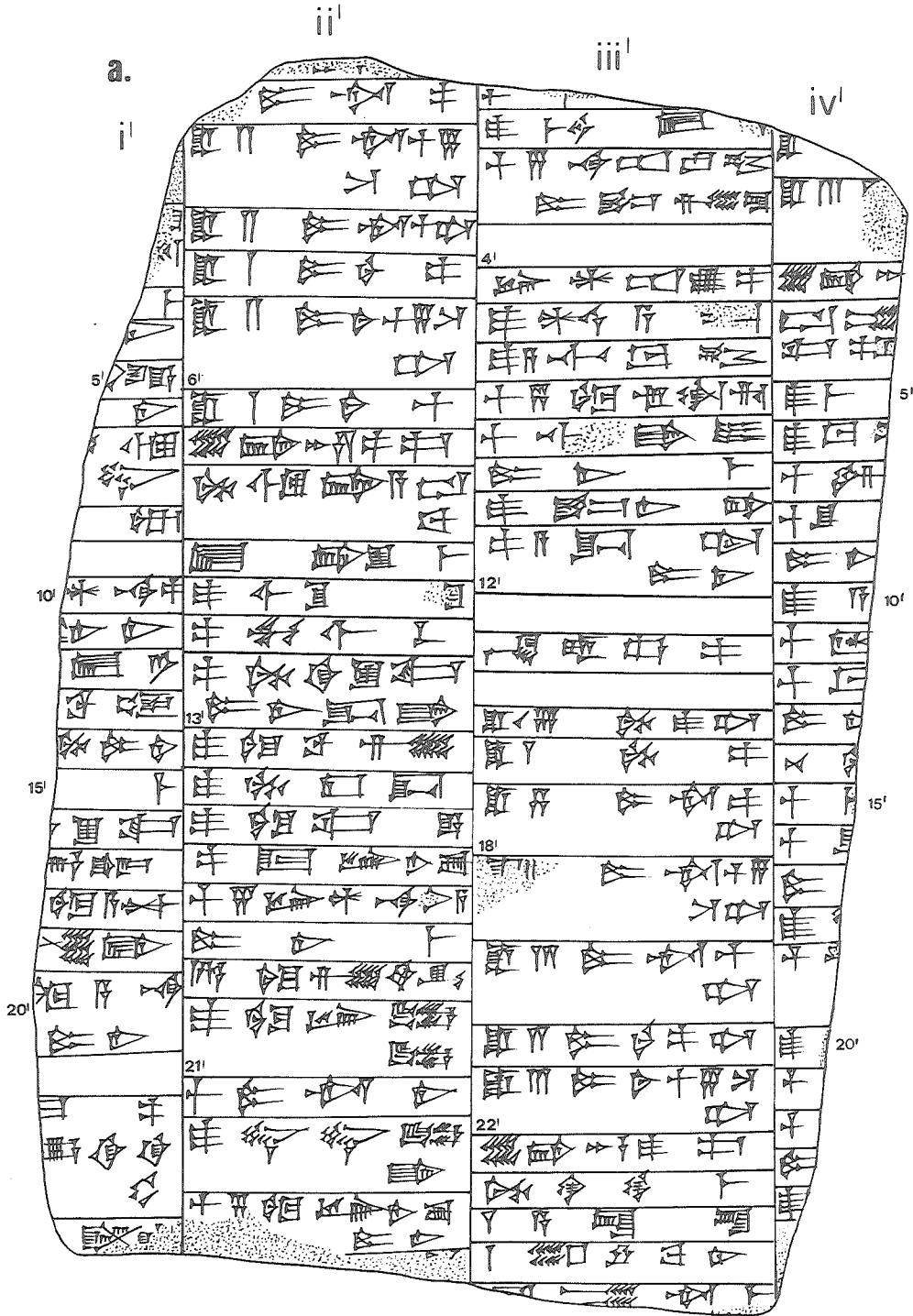

r.



286 (MM 225)

AnOr 7 286
Umma
ŠS6/viii/21

286. Sello:

A-tu dub-sar
dumu Ni₃-gar-ki-du₁₀
gal₃-la₂-[gal]

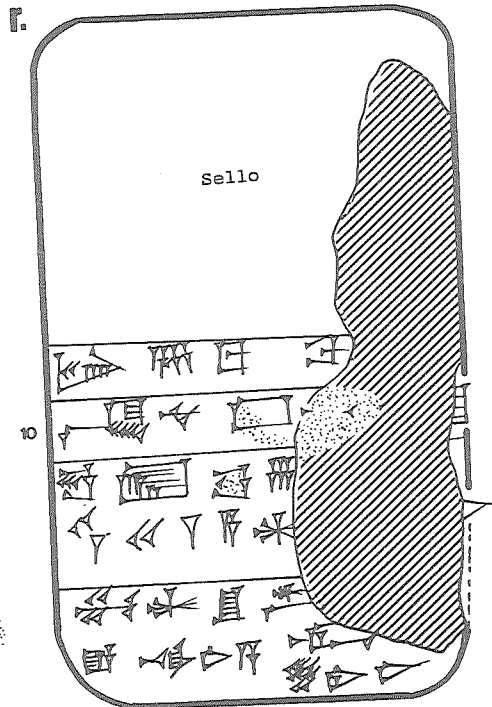
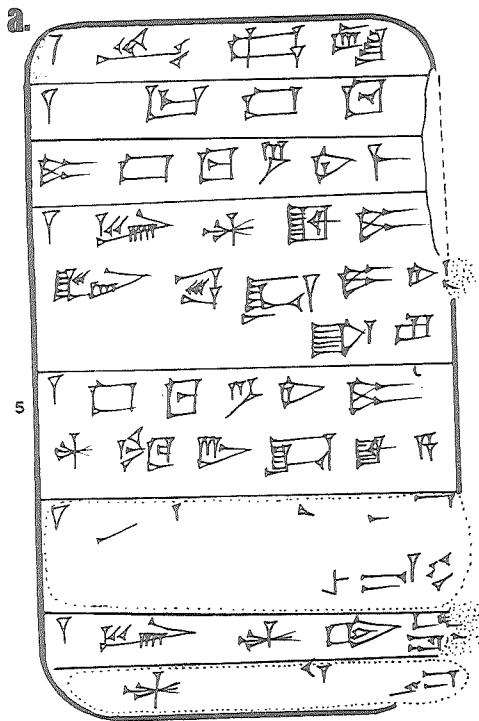

287 (MM 377)

AnOr 7 287
Umma
Š35/vii/-

287. Sello:

Lugal-ti-da
[du]mu Giri₃-ne₂
[aga₃-us₂] [en]si₂

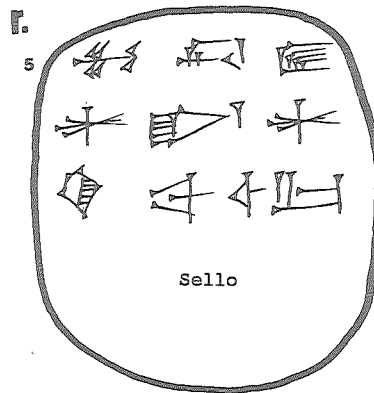
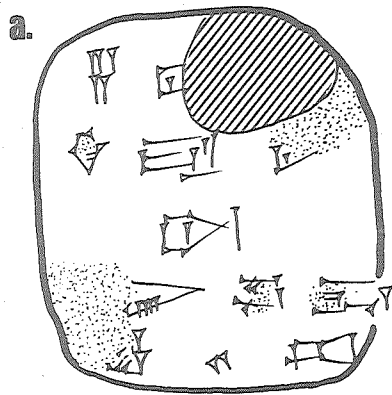

288 (MM 428)

AnOr 7 288
Umma
AS3/iii/[?]

288. Sello:

Ur-[...]
dumu U[š-...]

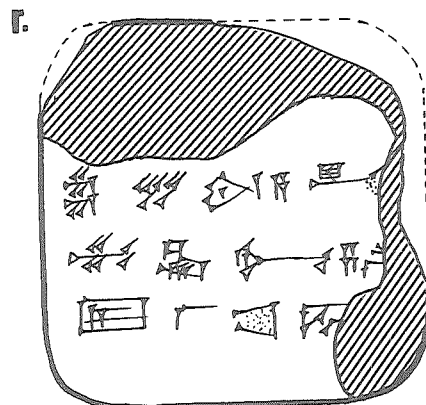
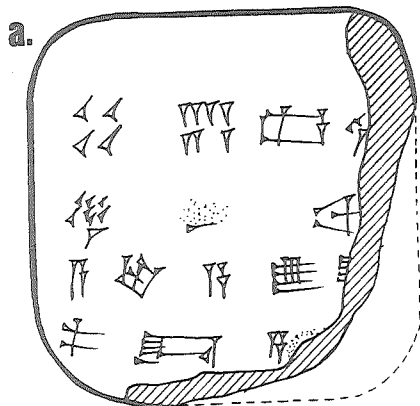

289 (MM 493)

AnOr 7 289
Umma
AS7/vii³/-

289. Sello:

- i ^dAmar-^dSuen
nita kal-ga
lugal Uri₃/^{ti}-ma
lugal ^dUb-/da limmu₂-ba
- ii Ur-^dLi₉-si₄
ensi₂
Umma^{is}
arad₂-zu

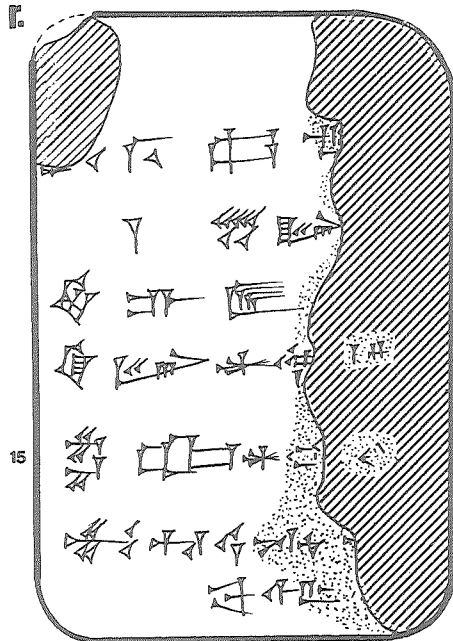
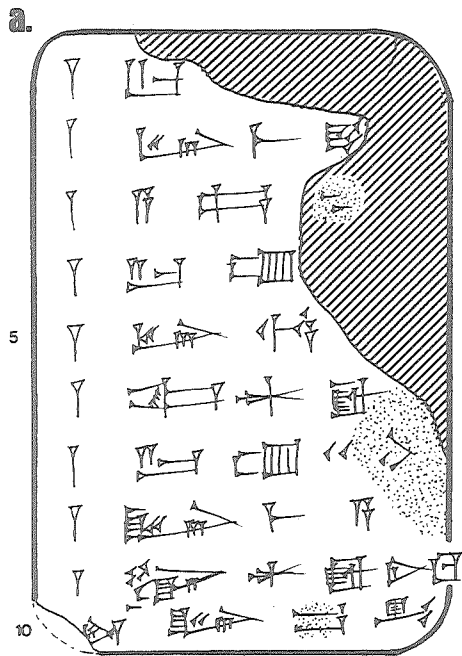

290 (MM 596)

AnOr 7 290
Lagaš
-/iii/3

Perdida aprox. media tablilla

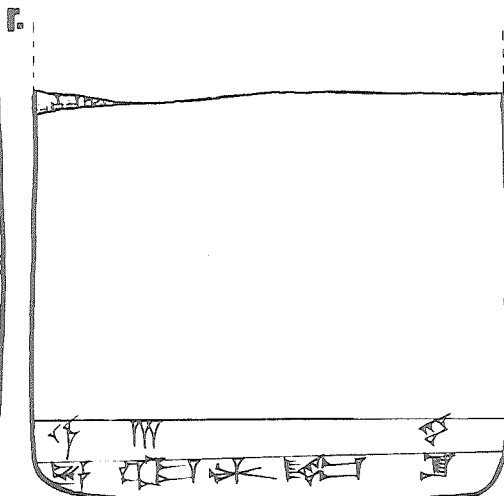
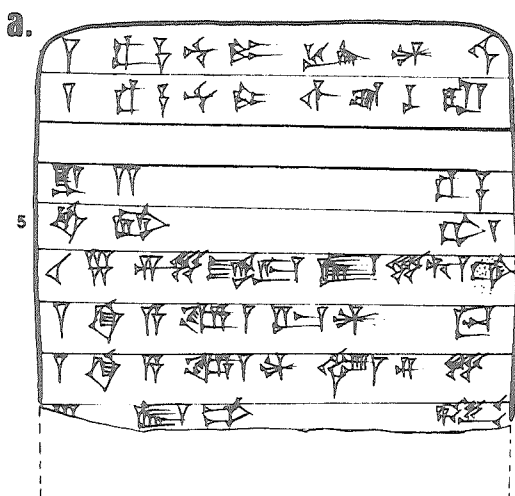

291 (MM 387)

AnOr 7 291
Umma
Š35/xii/-

291. Sello:

Lugal-inim-g[i-na]
dub-sar
dumu Lugal-ne[sag₂-e]

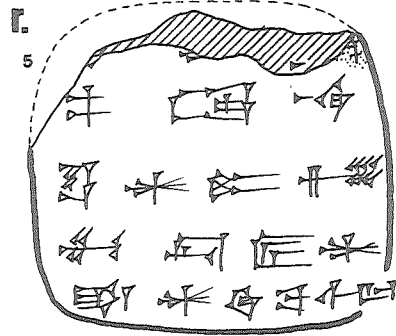
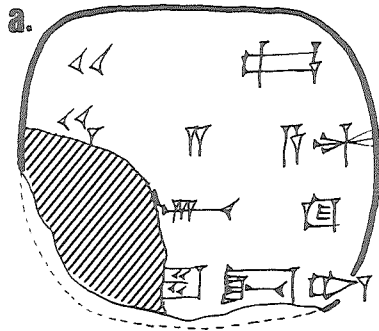

292 (MM 414)

AnOr 7 292
Umma
AS3/vi'/?

292. Sello:

Ur-e₂-mah
dub-[sar]
dumu Lugal-k[u₃-ga-ni]

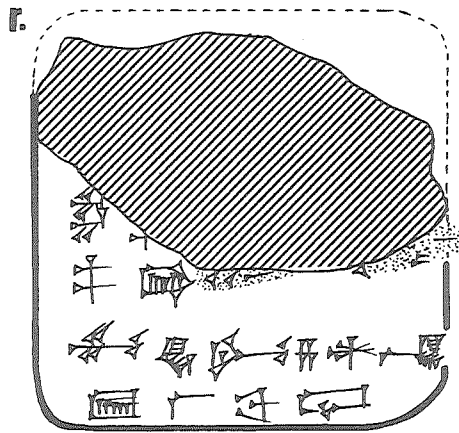
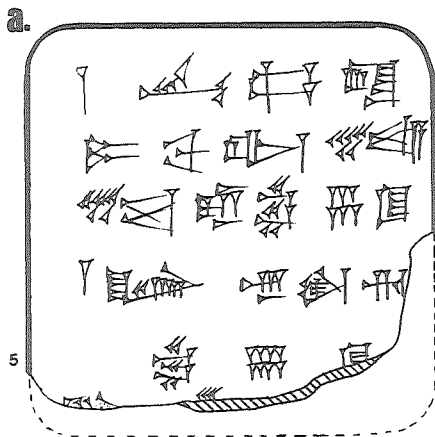

293 (MM 567)

AnOr 7 293
Umma
ŠS2/- (iii-viii)

293. Sello:

Dingir-[ra]
dub-[sar]
dumu Lu₂-[ga]

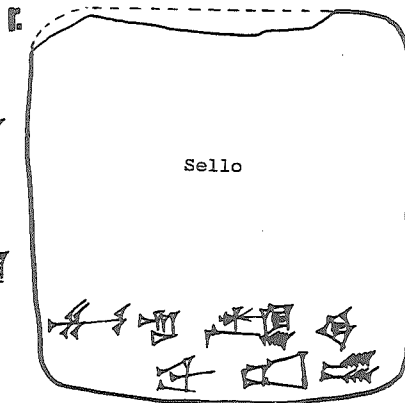
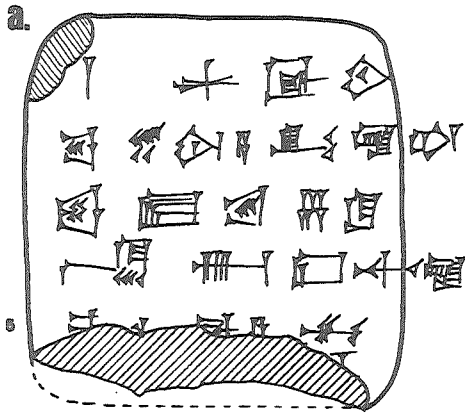

294 (MM 577)

AnOr 7 294
Umma'
[]

Perdida aprox. media tablilla

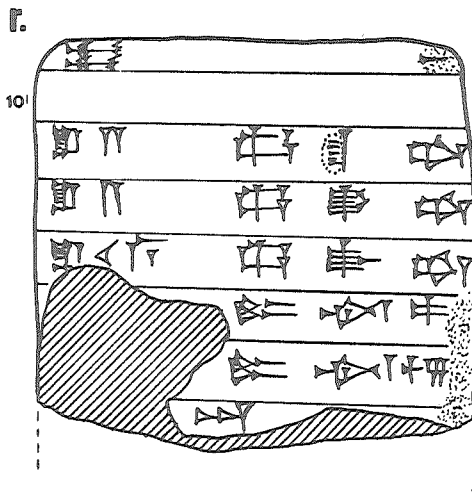
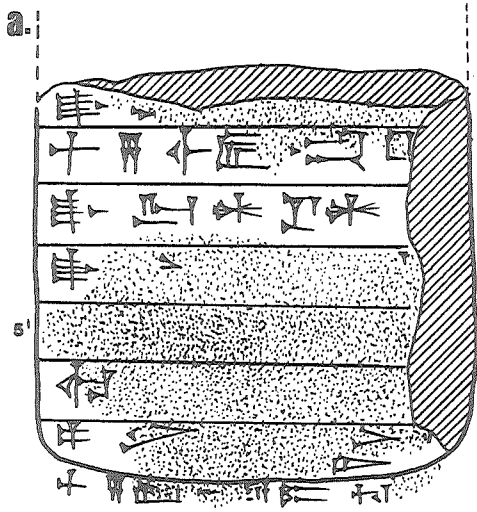

295 (MM 186)

AnOr 7 295
Umma o Lagaš
[]

Perdida aprox. media tablilla
(serrada con fines comerciales)

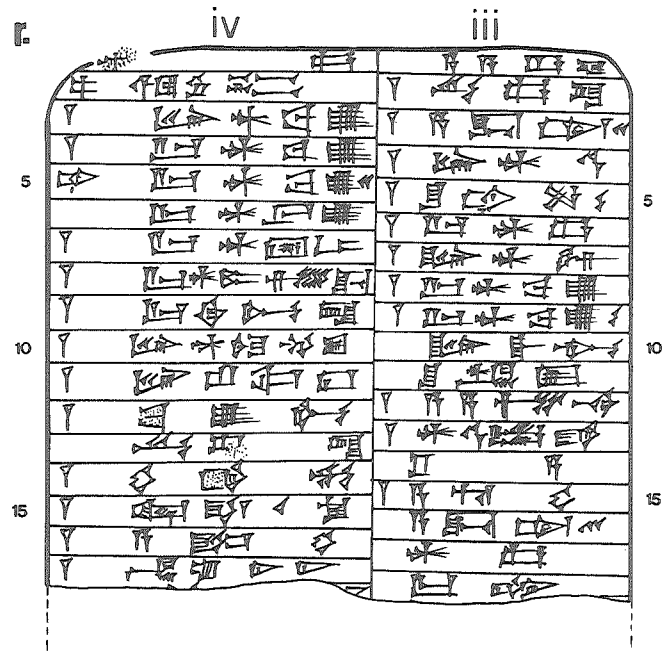
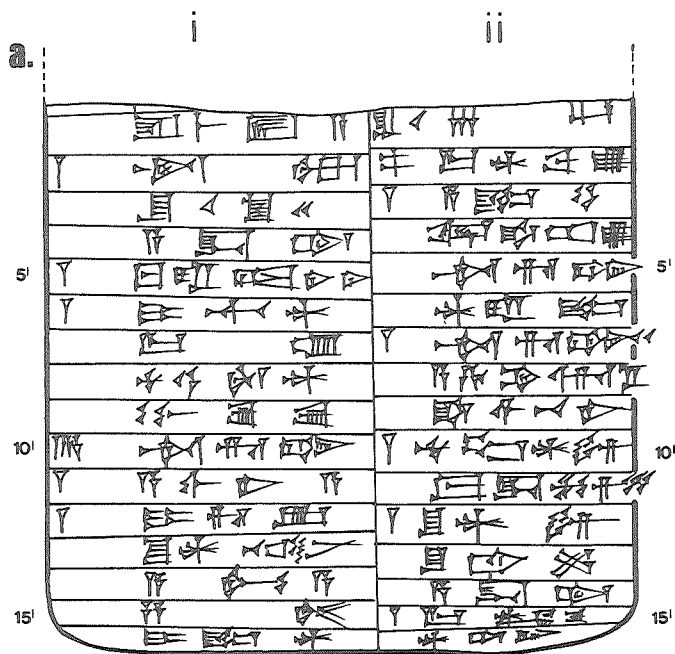

296 (MM 190)

AnOr 7 296
Umma
[1]

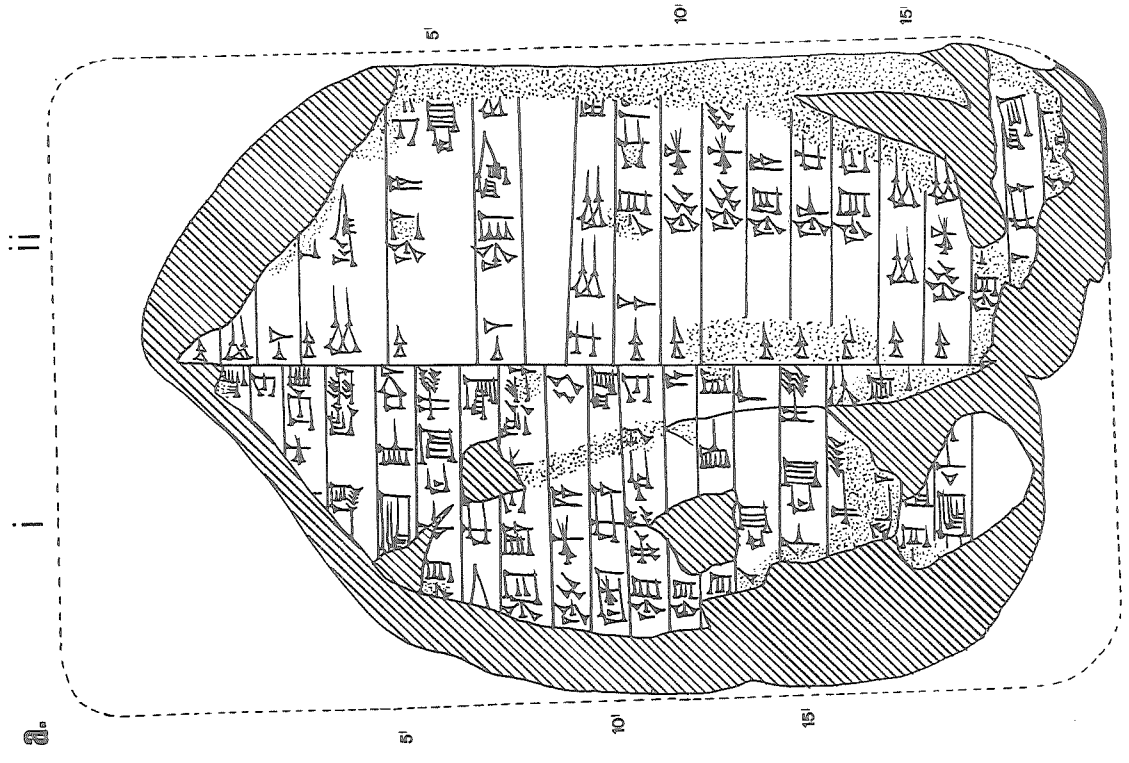
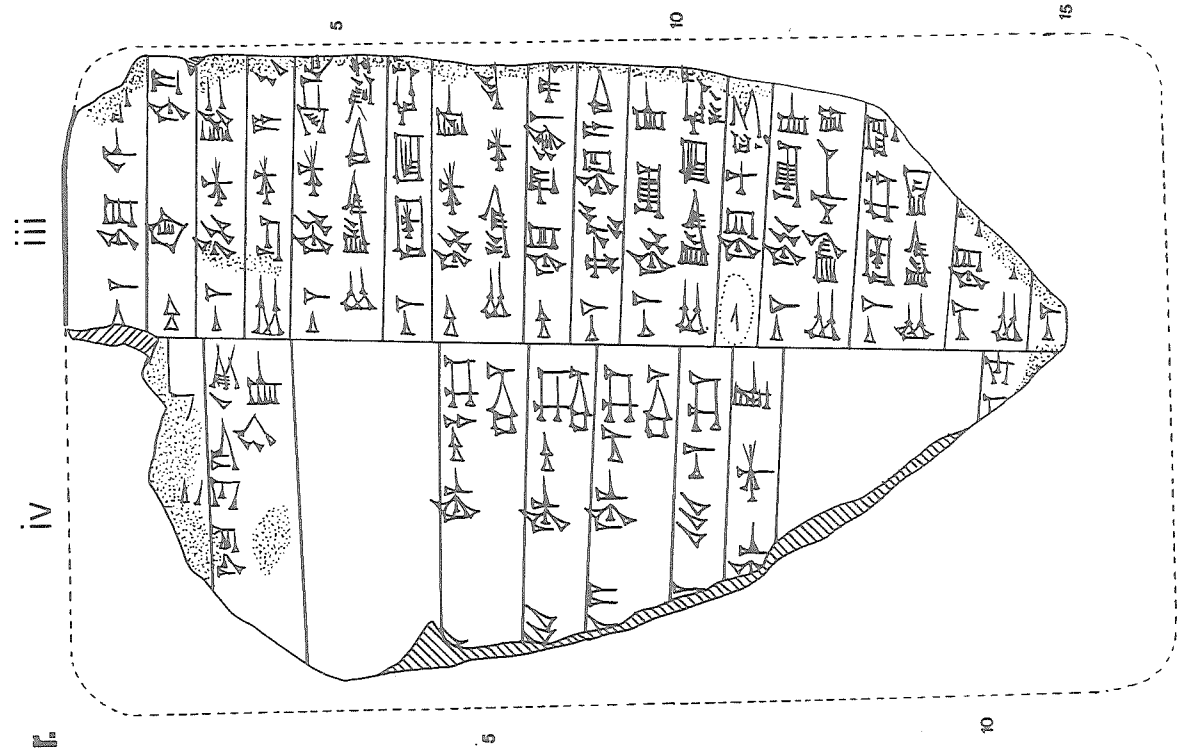

297 (MM 521)

AnOr 7 297
Umma
Š43/-

297. Sello:

A-kal-la
dub-sar
dumu Ur-ni₂-gar /kuš,

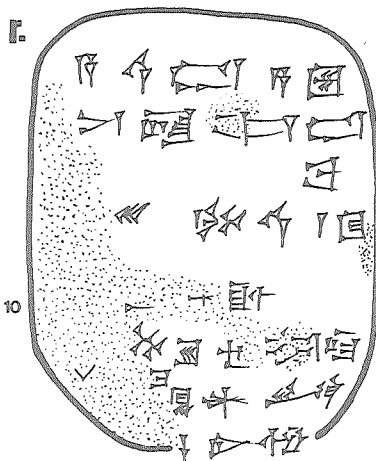
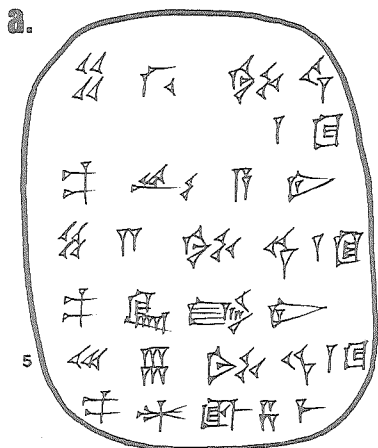

298 (MM 375)

AnOr 7 298
Umma
Š32 6 33/[]

298. Sello:

Lu₂-gi-na
dumu E₂-gal-x[...]

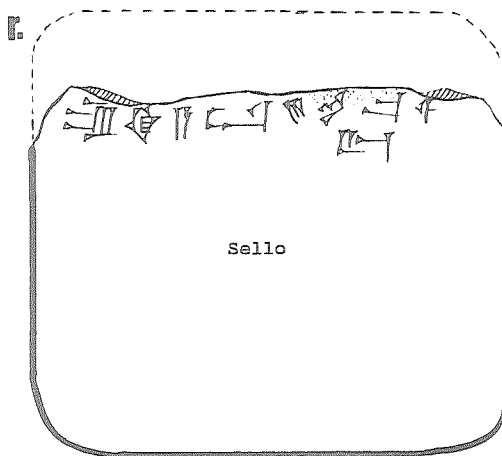
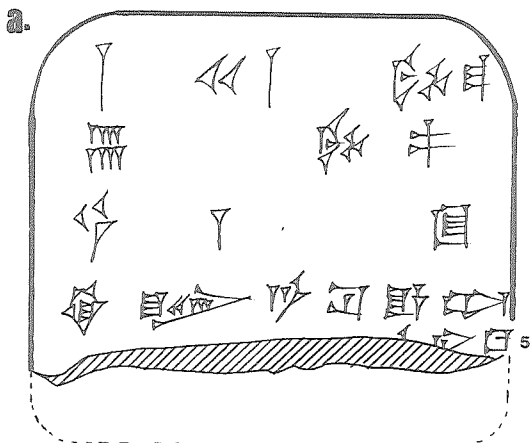

299 (MM 565)

AnOr 7 299
Umma
ŠS1/-

299. Sello:

A-a-kal-la
dub-sar
dumu Unken-ne₂

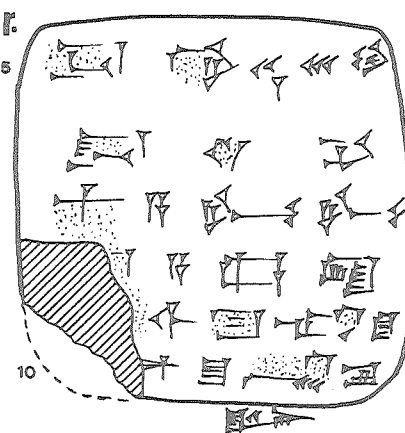

300 (MM 563)

AnOr 7 300
 Umma
 Š45 6 AS2/-/

300. Sello:

[E₂]-gal-e-[si]
 dub-[sar]
 dumu Lu₂-^d[Šara₂]
 sa₁₂-[du₃-ka]

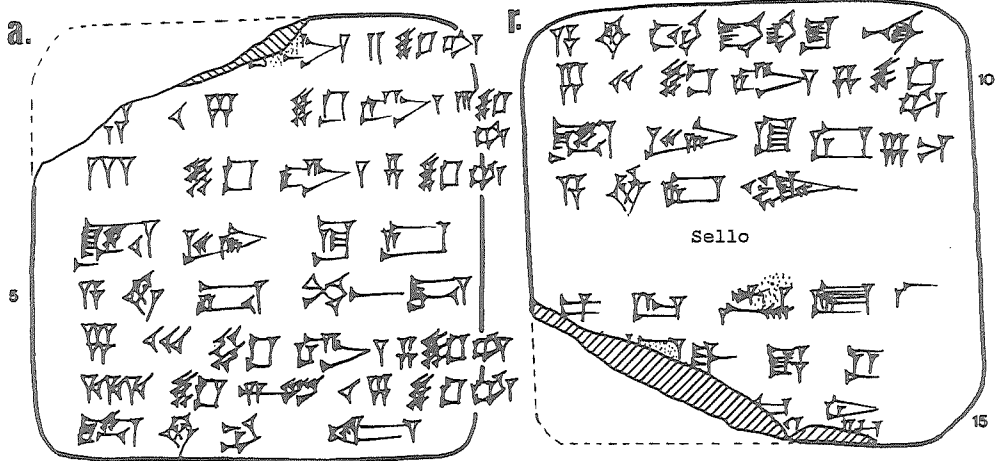

302 (MM 496)

AnOr 7 302
 Umma
 AS1/-/ {i-vi, []}

Perdido aprox. 1/3 de la tablilla

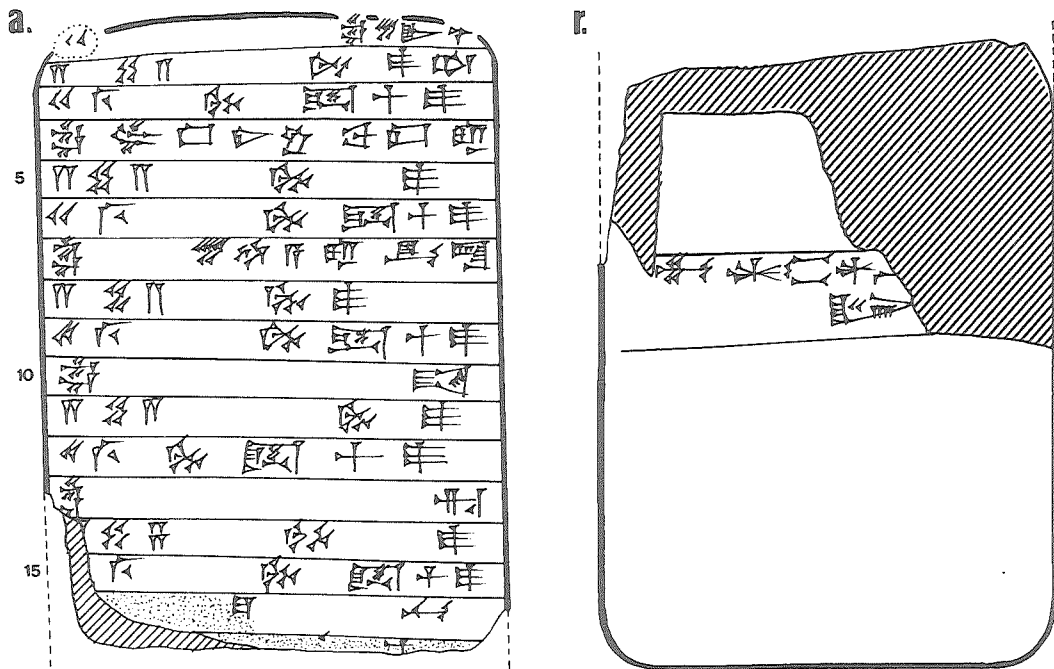

301 (MM 508)

AnOr 7 301
Umma
[]

Perdida aprox. media tablilla, originalmente con cuatro columnas por cada cara (serrada con fines comerciales)

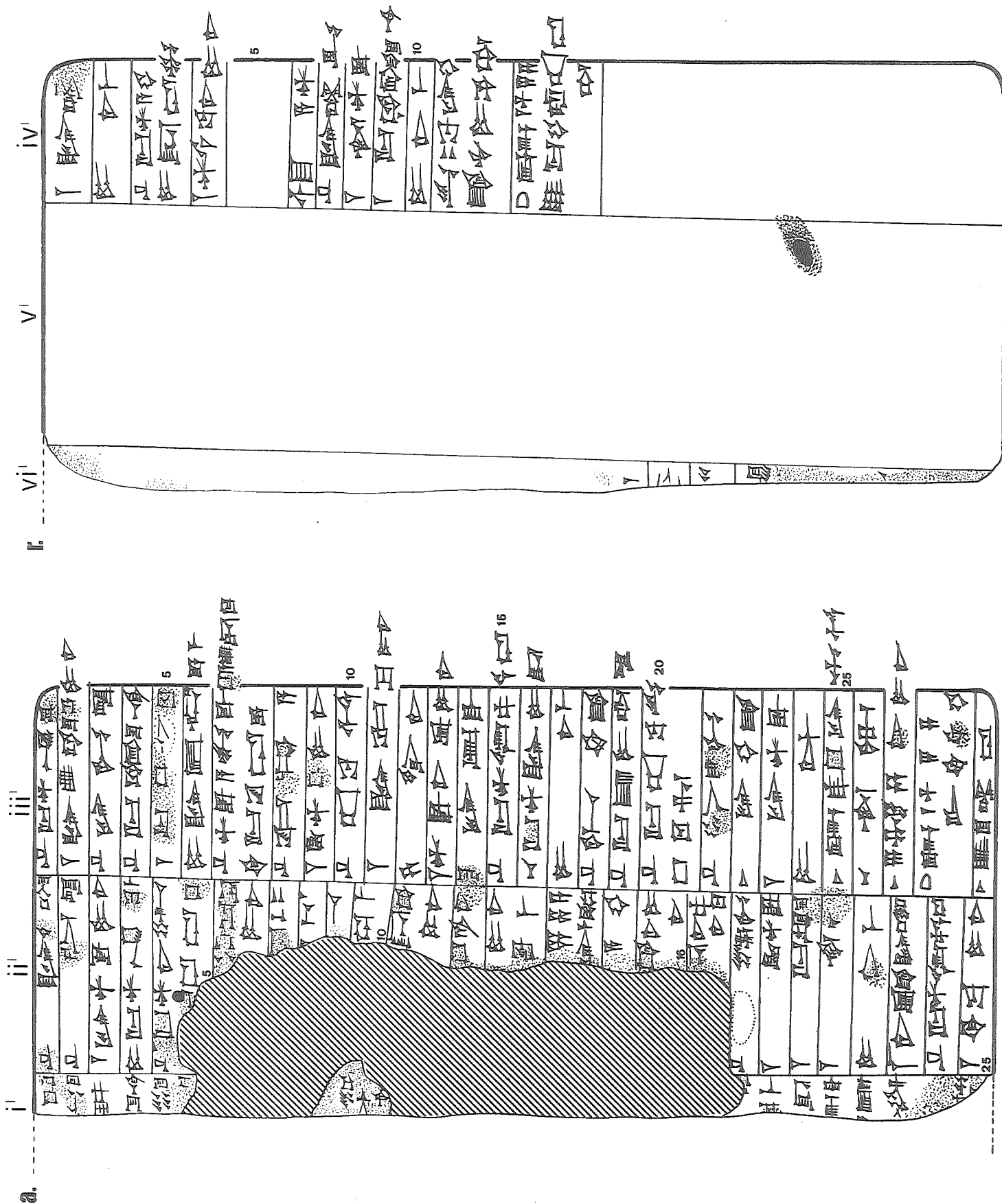

303 (MM 174)

Deimel *OrSP* 2 (1920) 55
AnOr 7 303
Umma
ŠS3/xiii/-

Perdidos aprox. 2 ó 3 cm de la tablilla

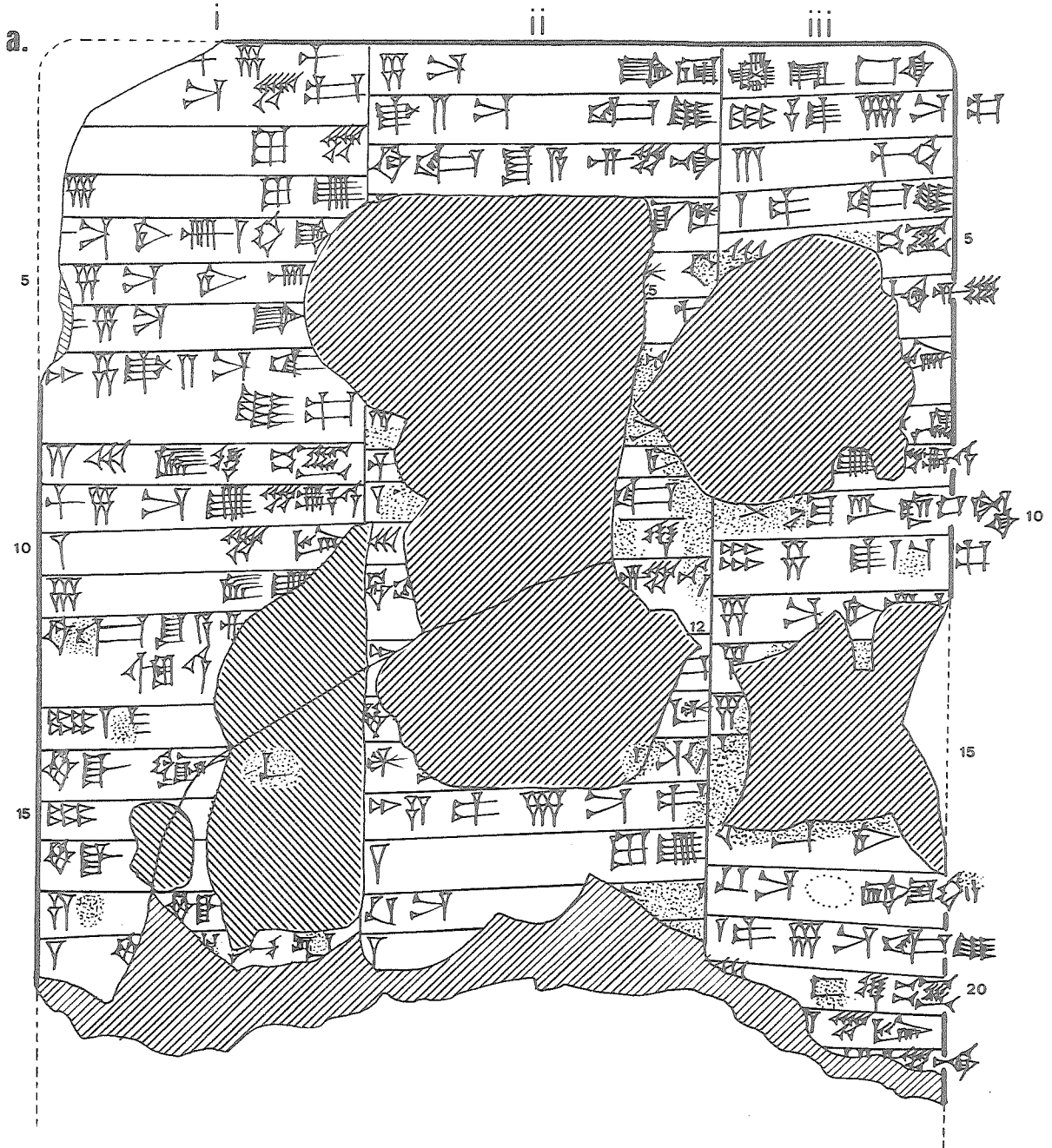

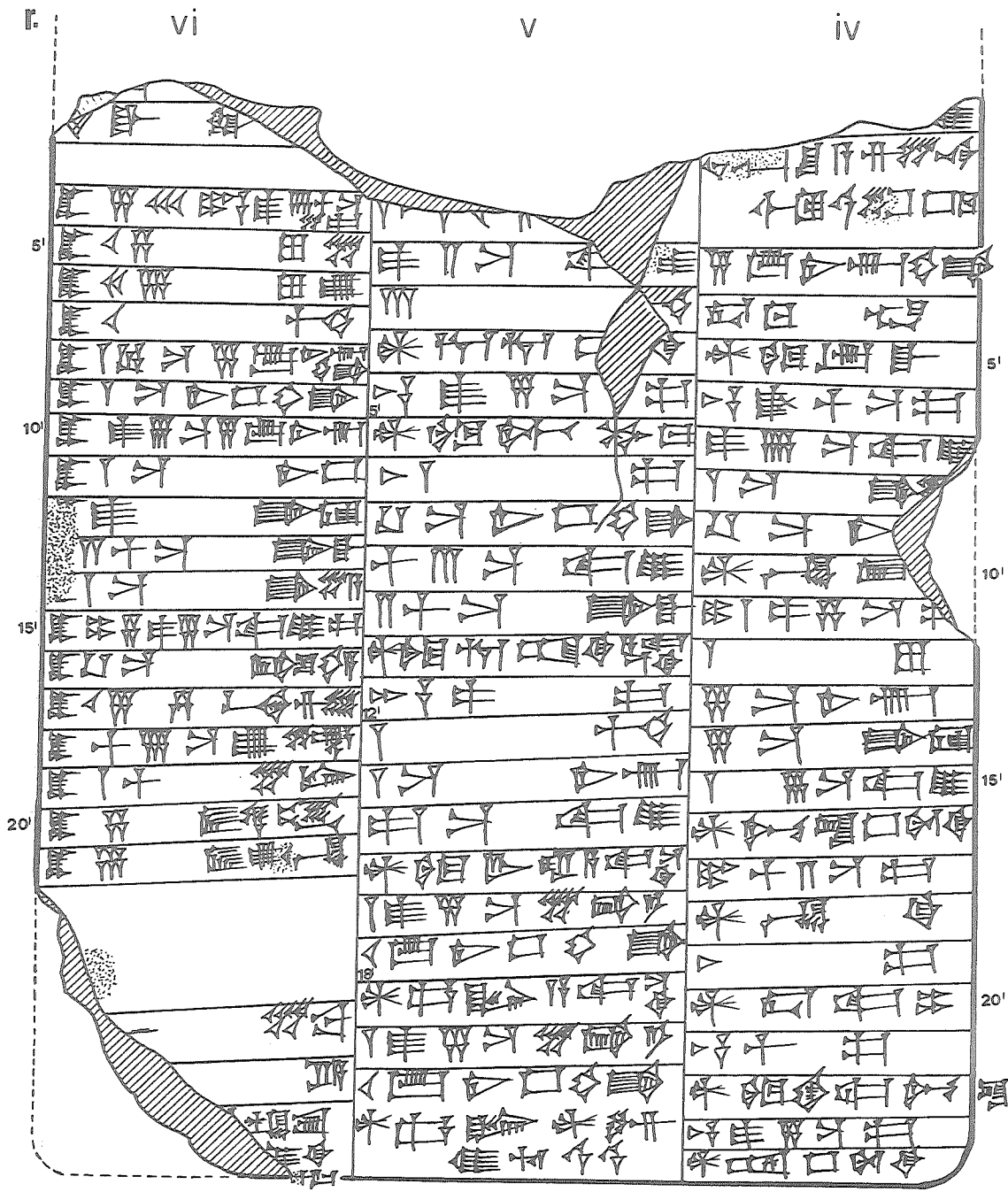

304 (MM 341)

AnOr 7 304
 Umma
 ŠS9/vi/[(x+)]7

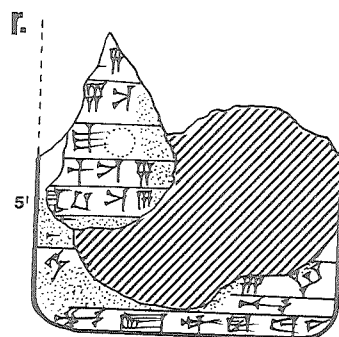
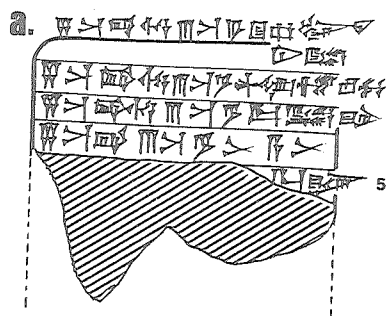

305 (MM 425)

AnOr 7 305
Umma
ŠS9/ix/22

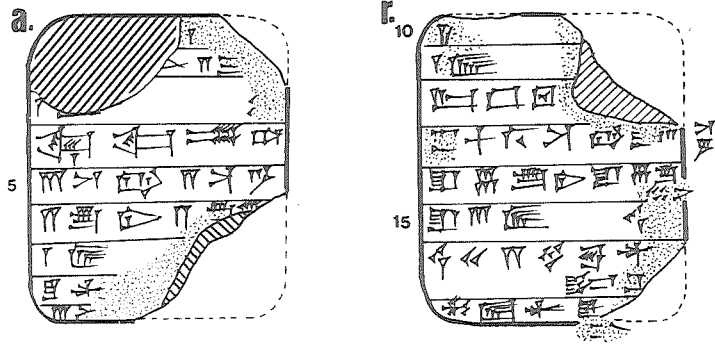

306 (MM 454)

AnOr 7 306
Umma
ŠS3/iii/21

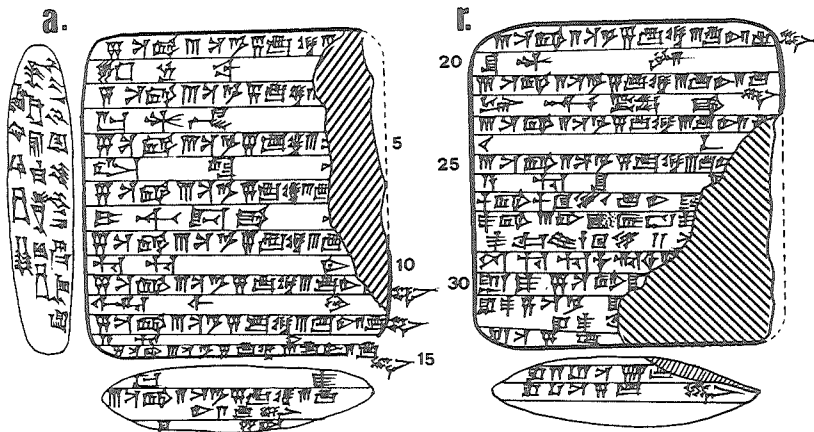

307 (MM 405)

AnOr 7 307
Umma?
-/-

Perdida aprox. media tabiilla

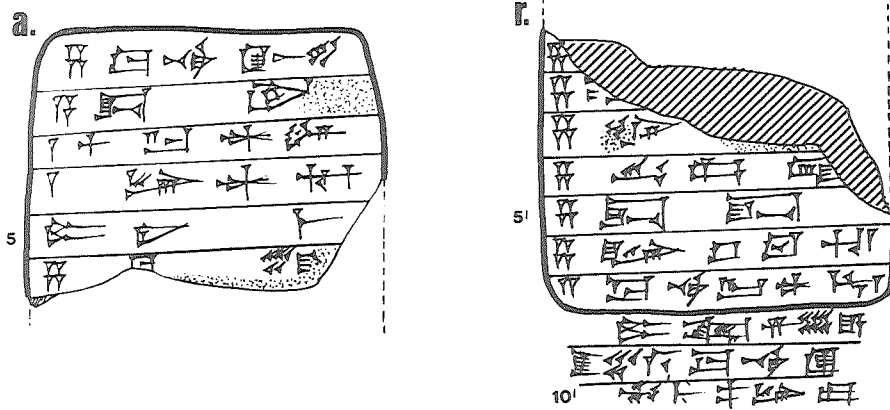

308 (MM 535)

AnOr 7 308
 Umma'
 []

Reverso destruido

308. Sello:

[...] Lugal-e₂-[...]

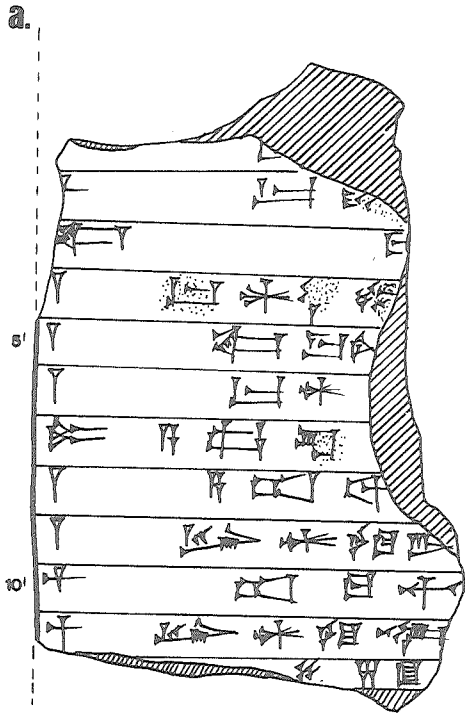

309 (MM 388)

AnOr 7 309
 Umma
 ŠS9/ii/-

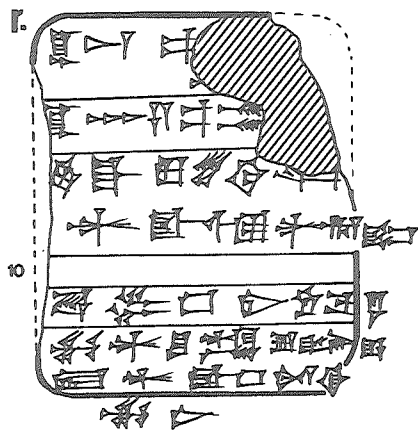
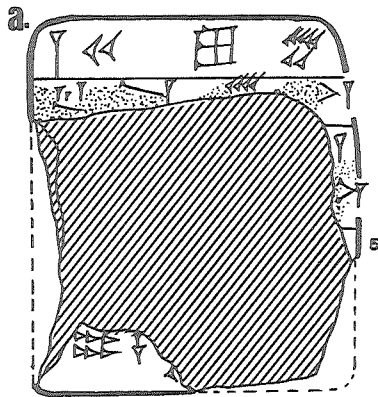

310 (MM 383)

AnOr 7 310
 Umma
 -/17,18

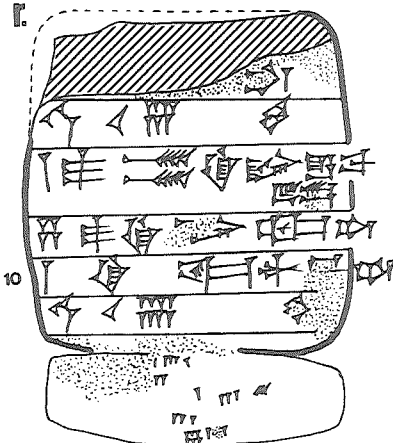
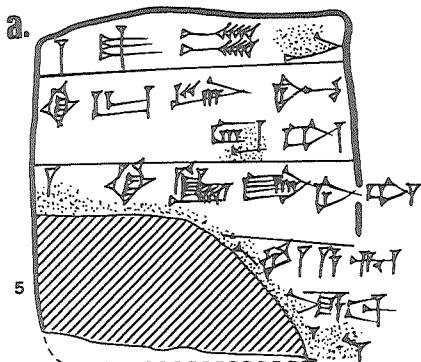

311 (MM 198)

AnOr 7 311
Umma
[]

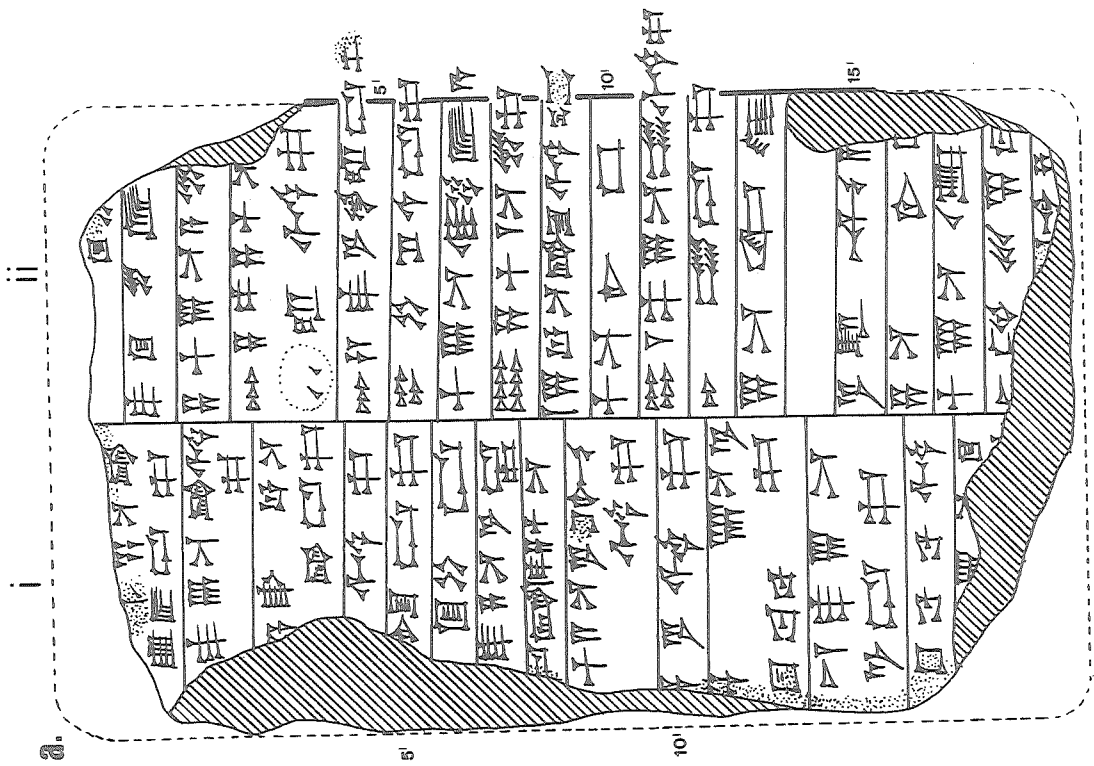
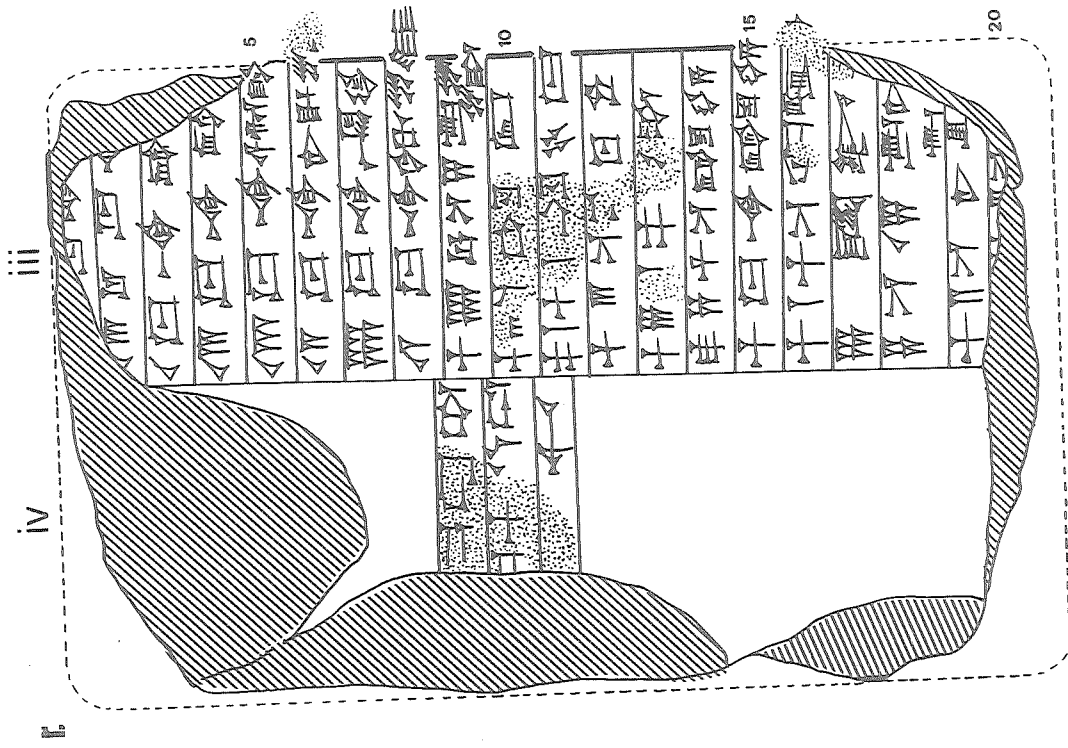

312 (MM 61)

AnOr 7 312
Lagaš?
Š44/-

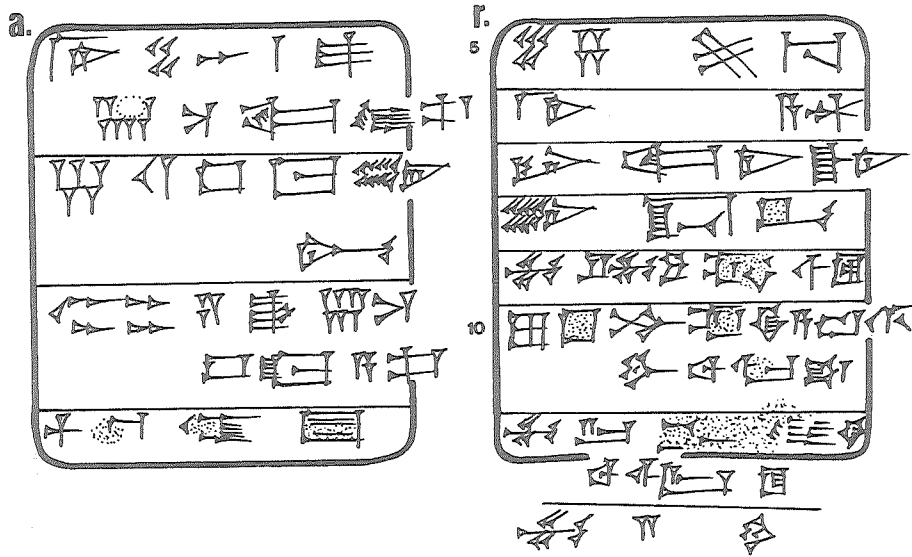

314 (MM 534)

AnOr 7 314
Umma
ŠS2 ó ŠS7/[]

314. Sello:

Šara₂-kam
dub-sar
dumu Lugal^{ab}-kiri₆

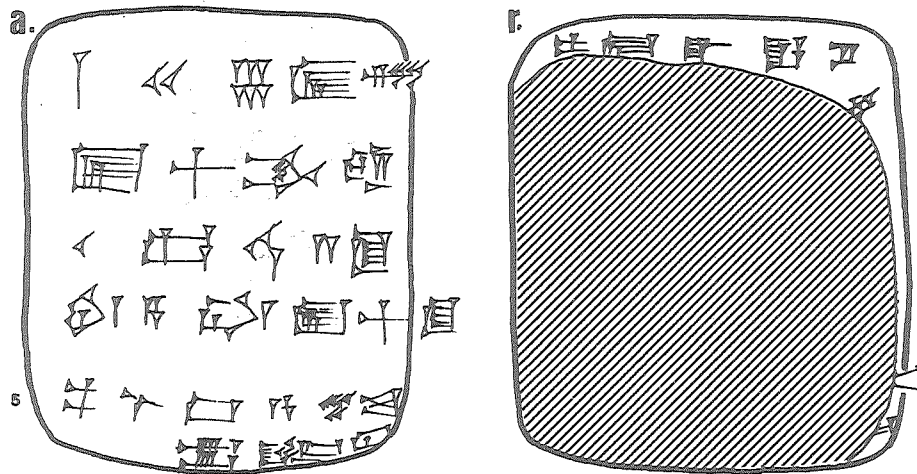

313 (MM 197)

AnOr 7 313
Umma
-/-

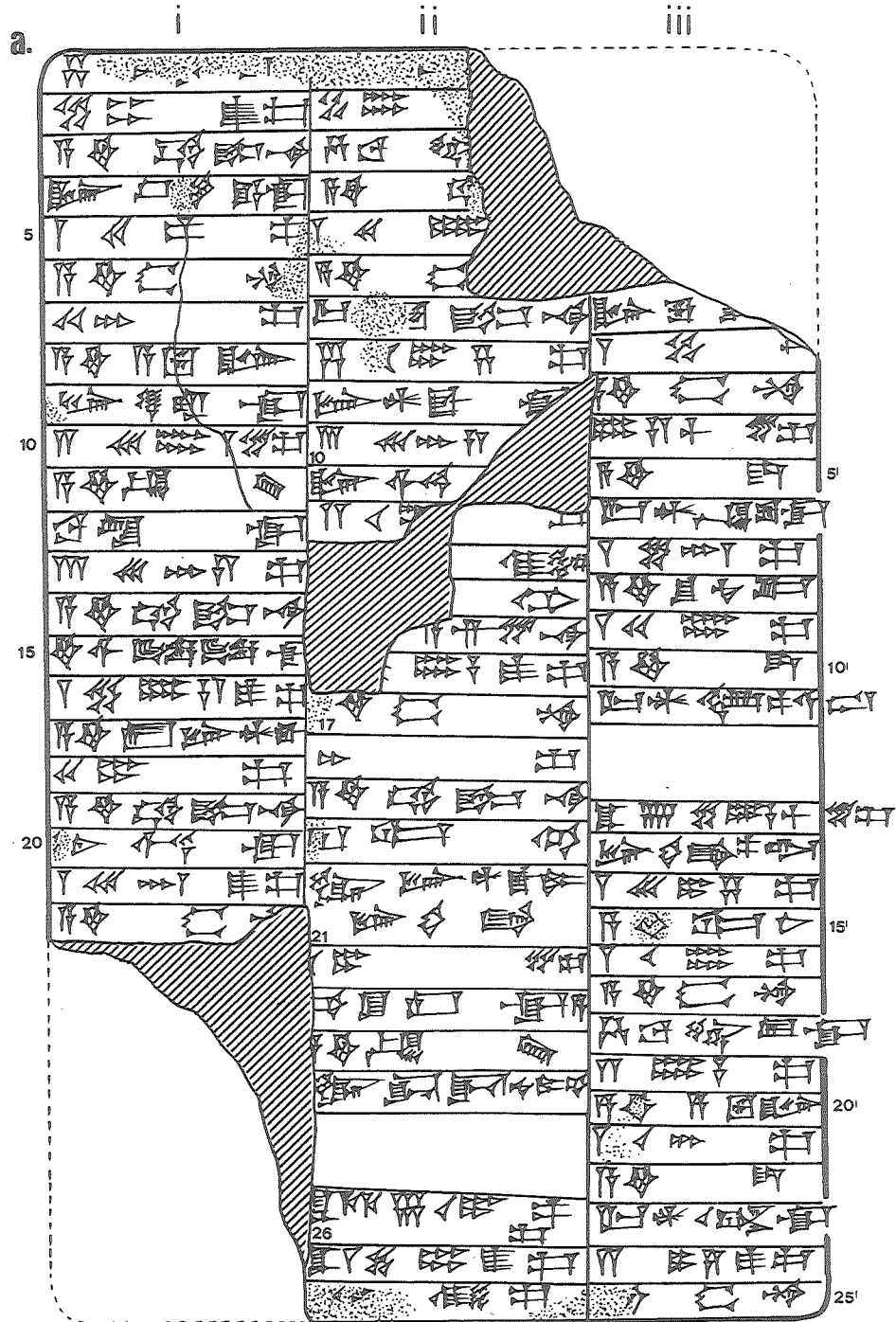

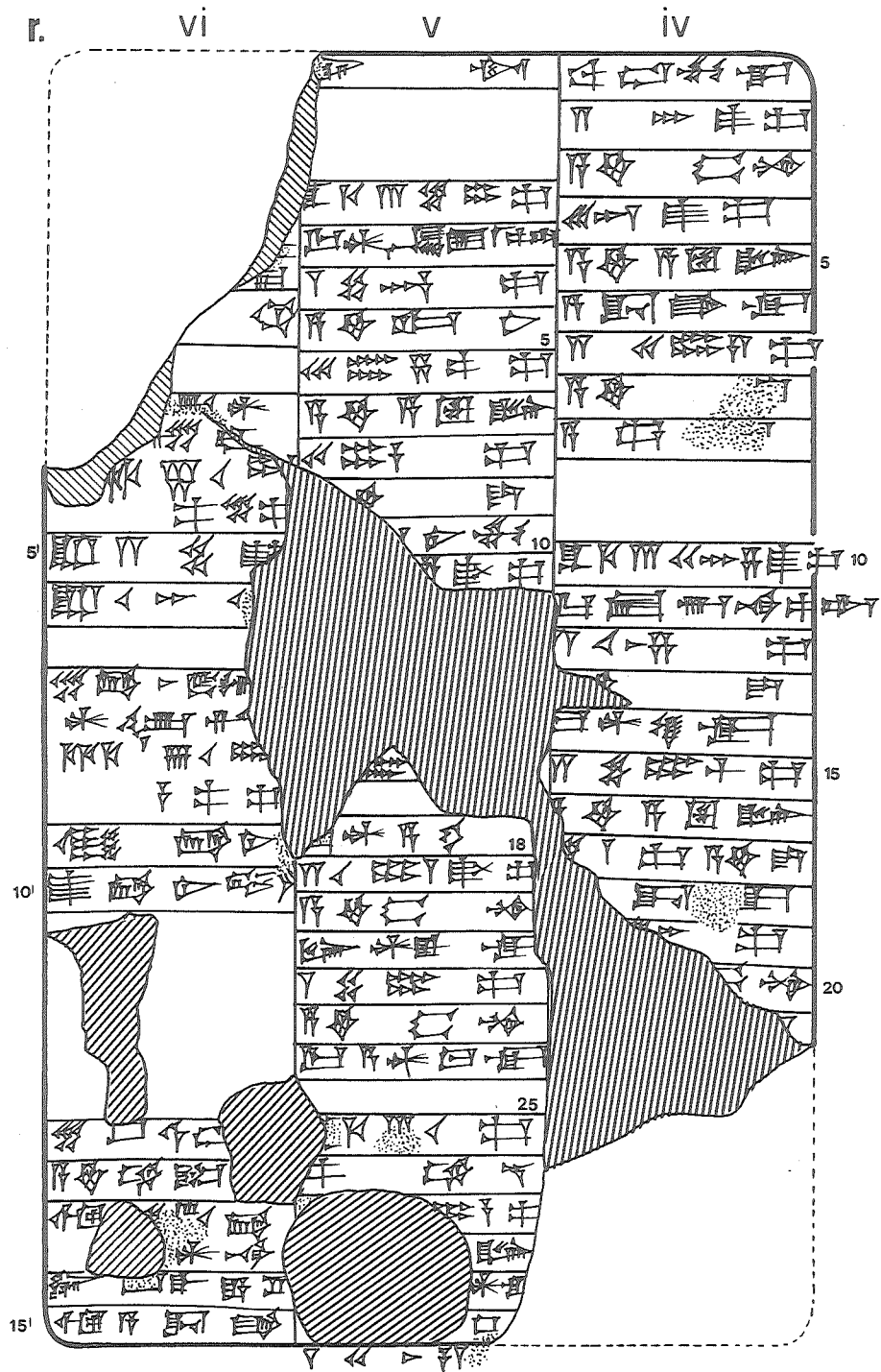

315 (MM 185)

AnOr 7 315
 Umma
 []

Perdido aprox. 1 cm de la tablilla

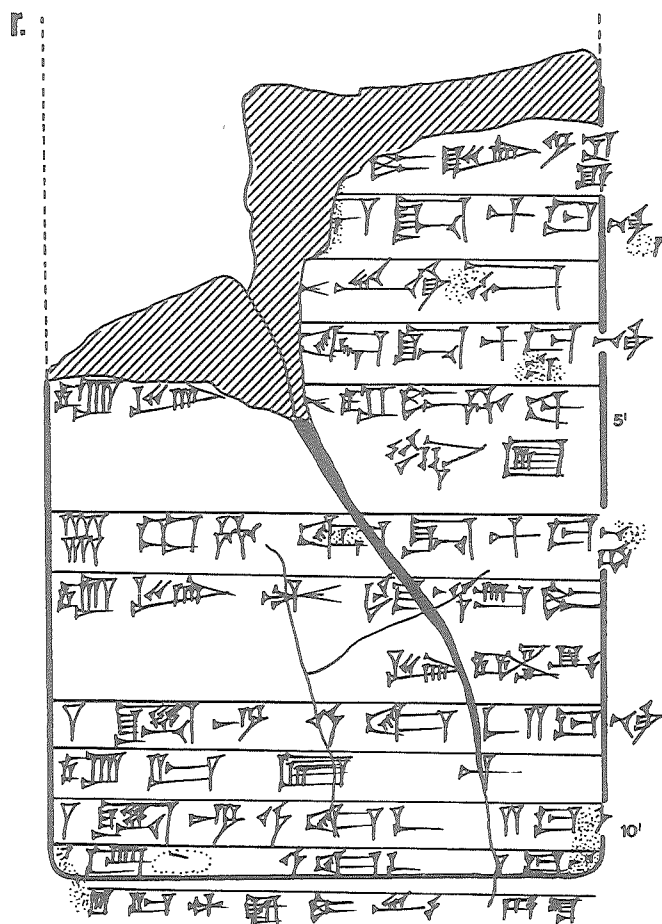
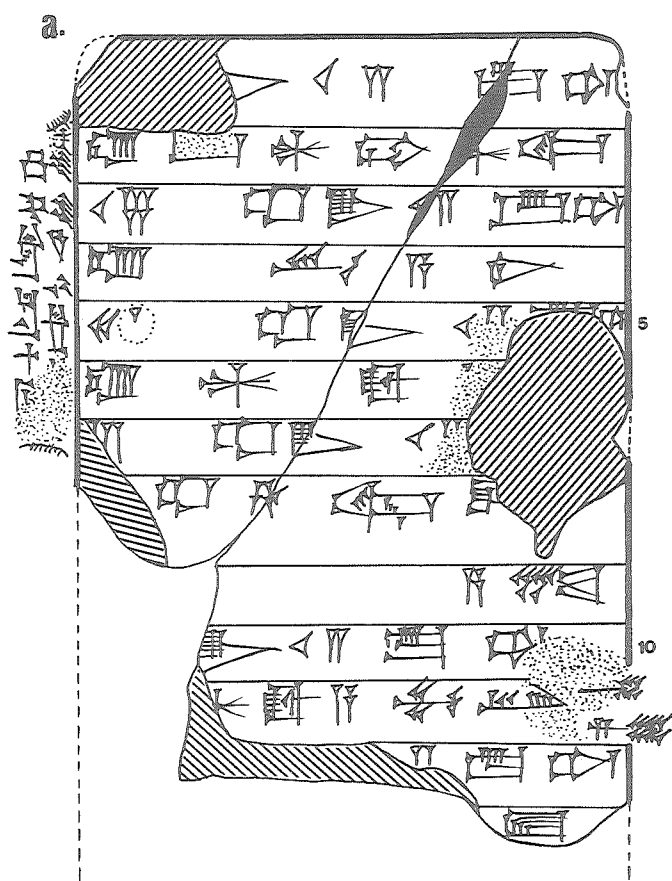

316 (MM 509)

AnOr 7 316
 Umma
 [] { [], AS9, šS1, šS2, [], AS8, []-šS1, šS1-šS5, šS6-[] }

Tablilla desaparecida

317 (MM 582)

AnOr 7 317
 ?
 IS3//I- {IS2}

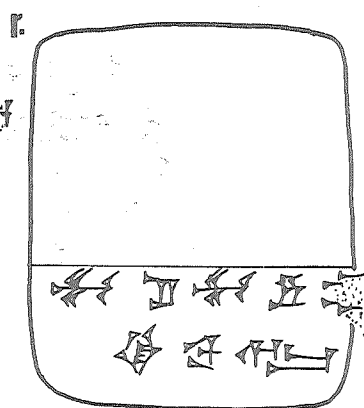
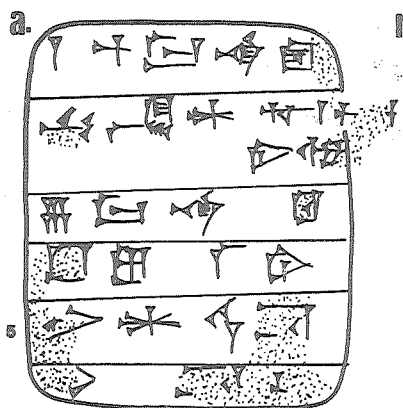

318 (MM 400)

AnOr 7 318
Umma
Š46/ix[?]

Perdida aprox. media tablilla

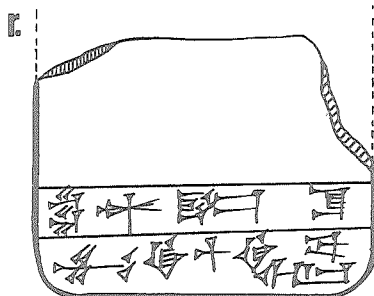
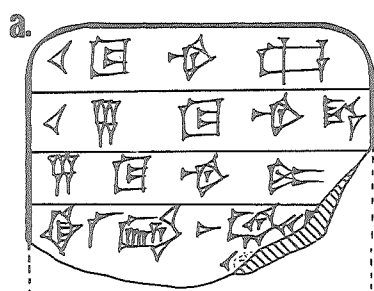

319 (MM 594)

AnOr 7 319
Umma
[]/-

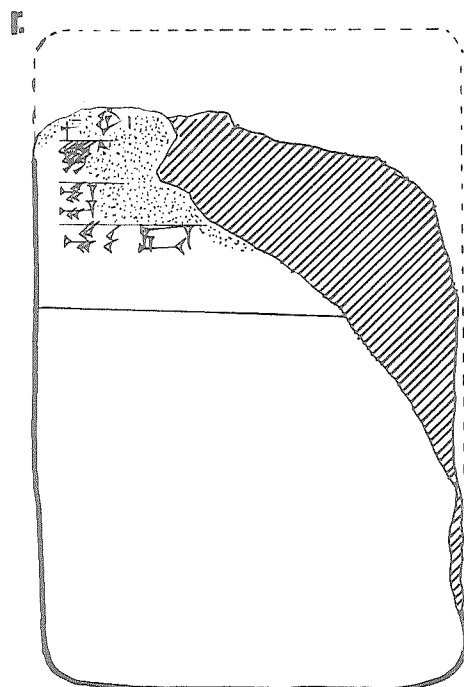
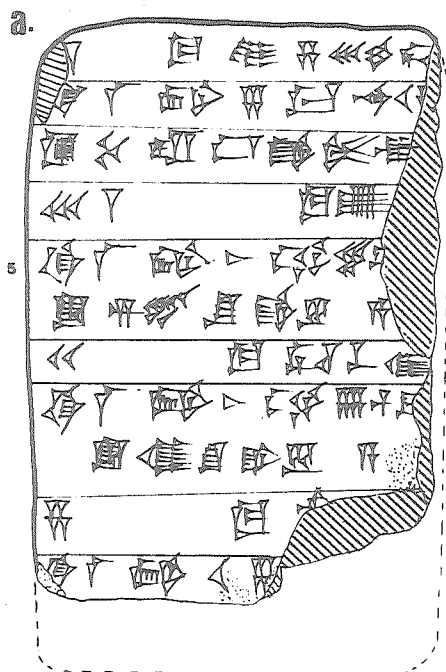

320 (MM 417)

AnOr 7 320
Umma
[]

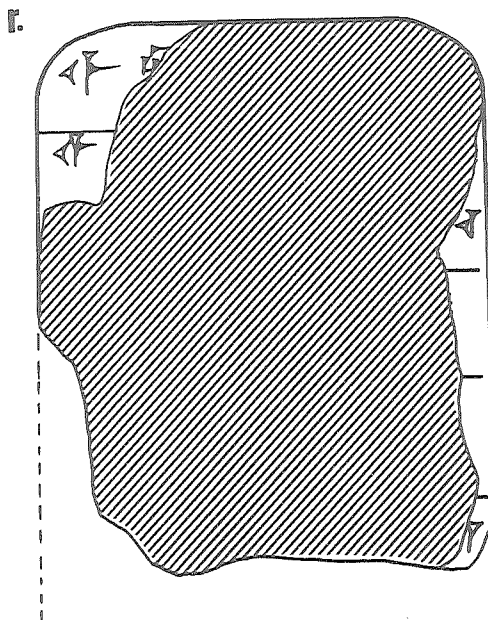
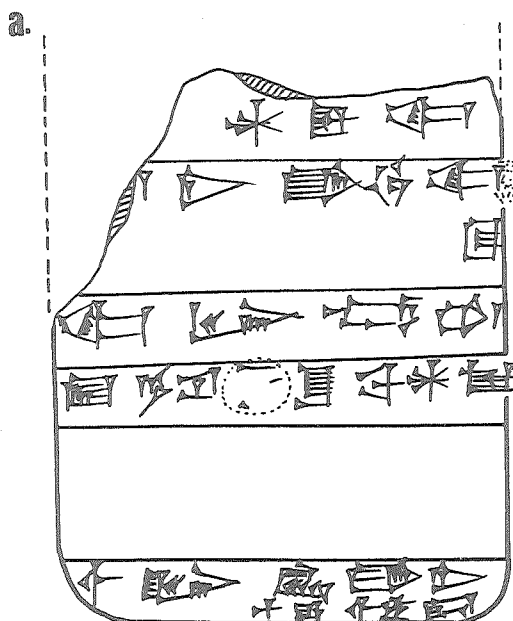

321 (MM 495)

AnOr 7 321
Umma'
AS2/-/-

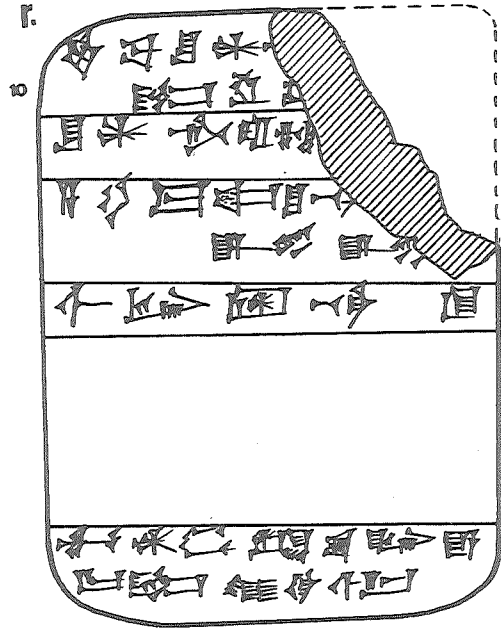
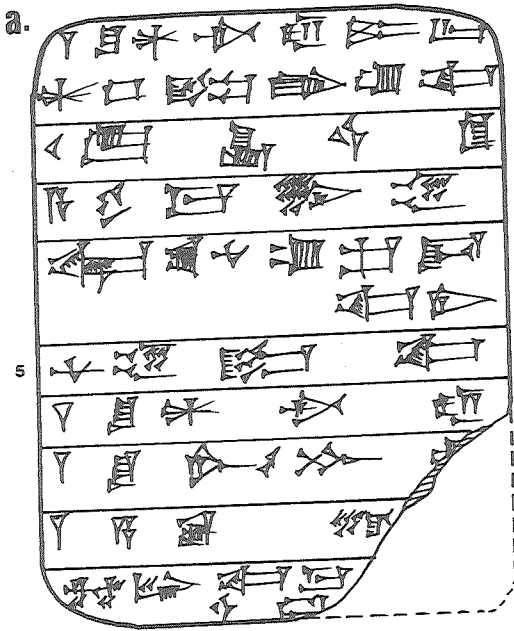

322 (MM 522)

AnOr 7 322
Umma
-/-

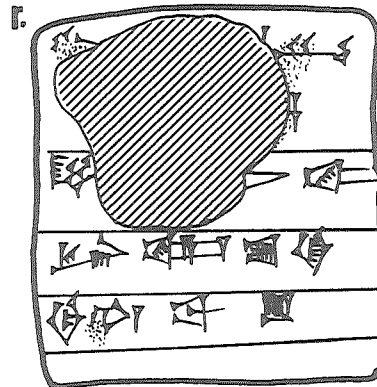
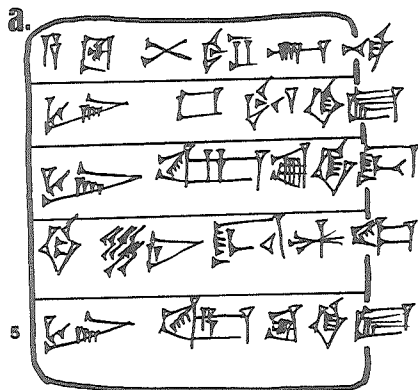

323 (MM 511)

AnOr 7 323
Umma
ŠS6/-/- (i)

323. Sello:

Lugal-e-ba-an-ša,
dub-sar
dumu Ur-4Išta[ran]

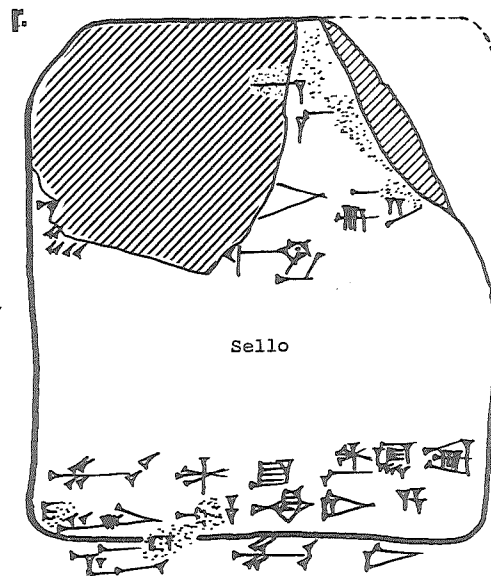
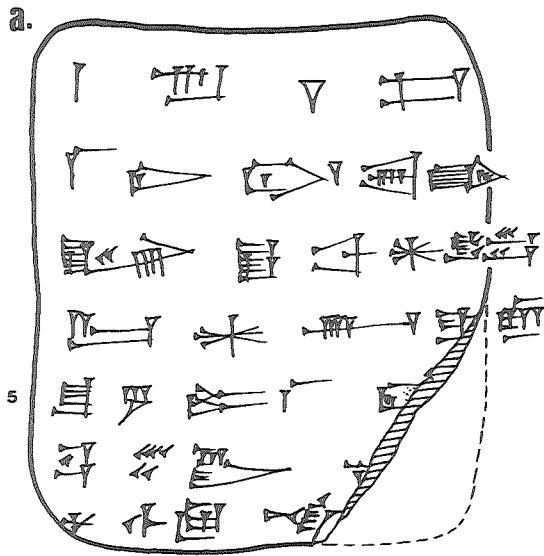

324 (MM 553)

AnOr 7 324
Umma
AS8/- (iv-v)

324. Sello:

Dingir-ra
dub-sar
dumu Lu₂-ga

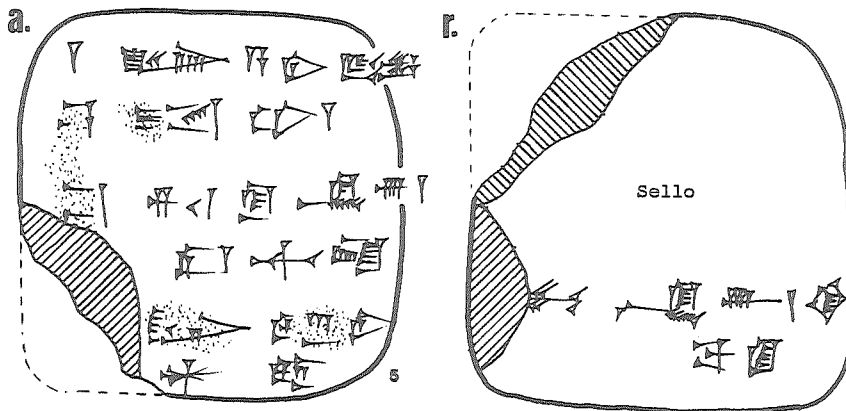

325 (MM 393)

AnOr 7 325
Umma
ŠS4/-

325. Sello:

Lu₂-⁴Šara₂
dub-sar
dumu Ur-ša₆-ga

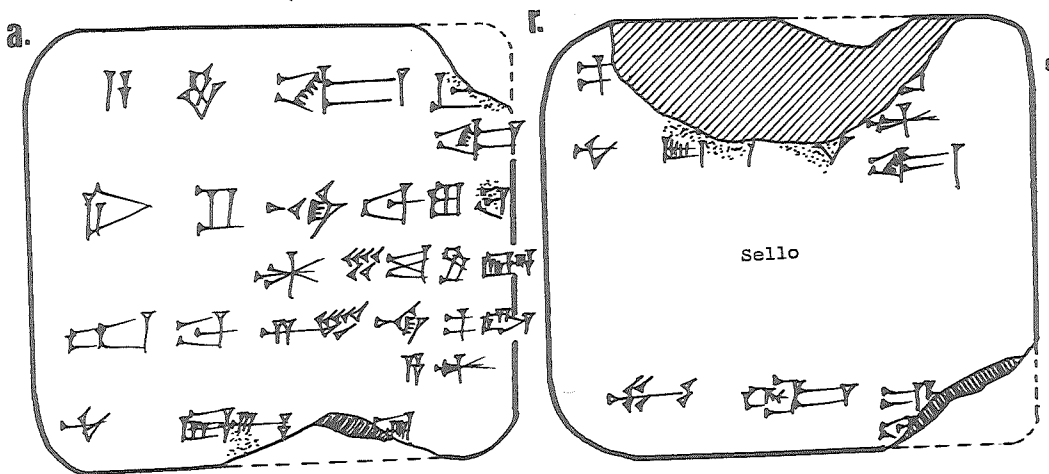

326 (MM 344)

AnOr 7 326
Umma
ŠS4 6 5/[]

Perdidos aprox. 2/3 de la tablilla

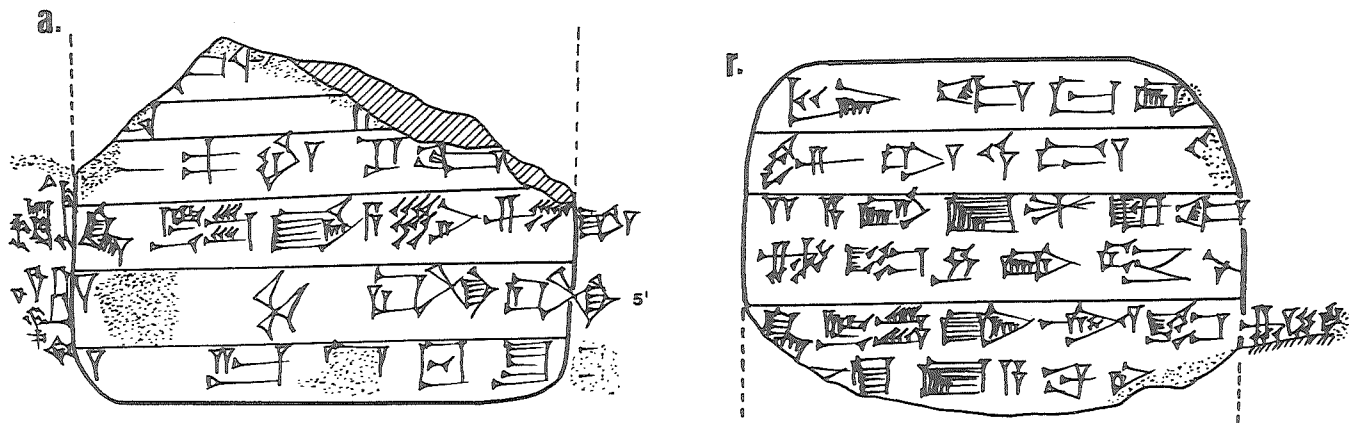

327 (MM 164)

AnOr 7 327
Umma
AS5/xii/-

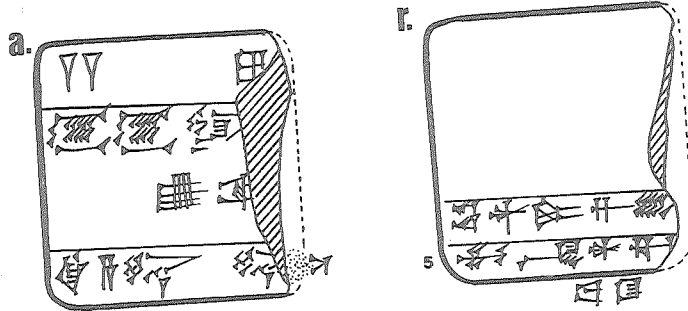

328 (MM 180)

AnOr 7 328
Umma
ŠS4/-

328. Sello ilegible

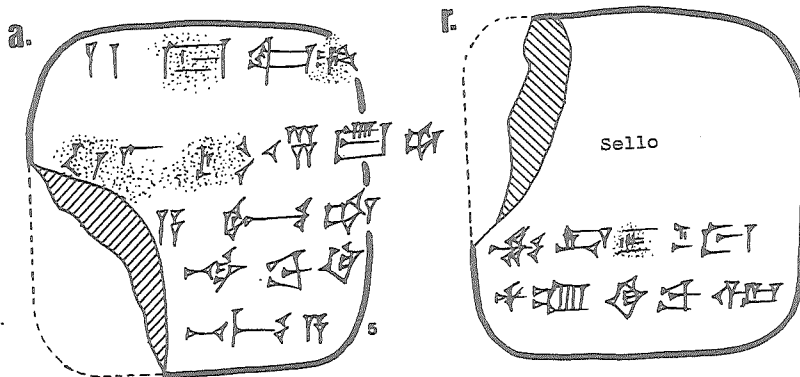

330 (MM 80)

AnOr 7 330
Umma
[] {Š45-46, []}

Perdida aprox. media tablilla
(serrada con fines comerciales)

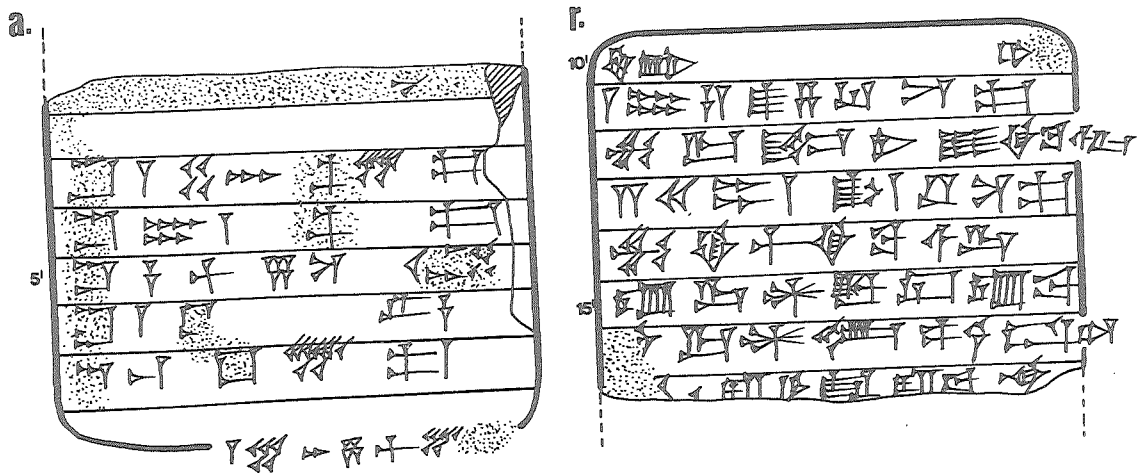

329 (MM 195)

AnOr 7 329
Umma
[]

Perdidos aprox. 2 cm de la tablilla

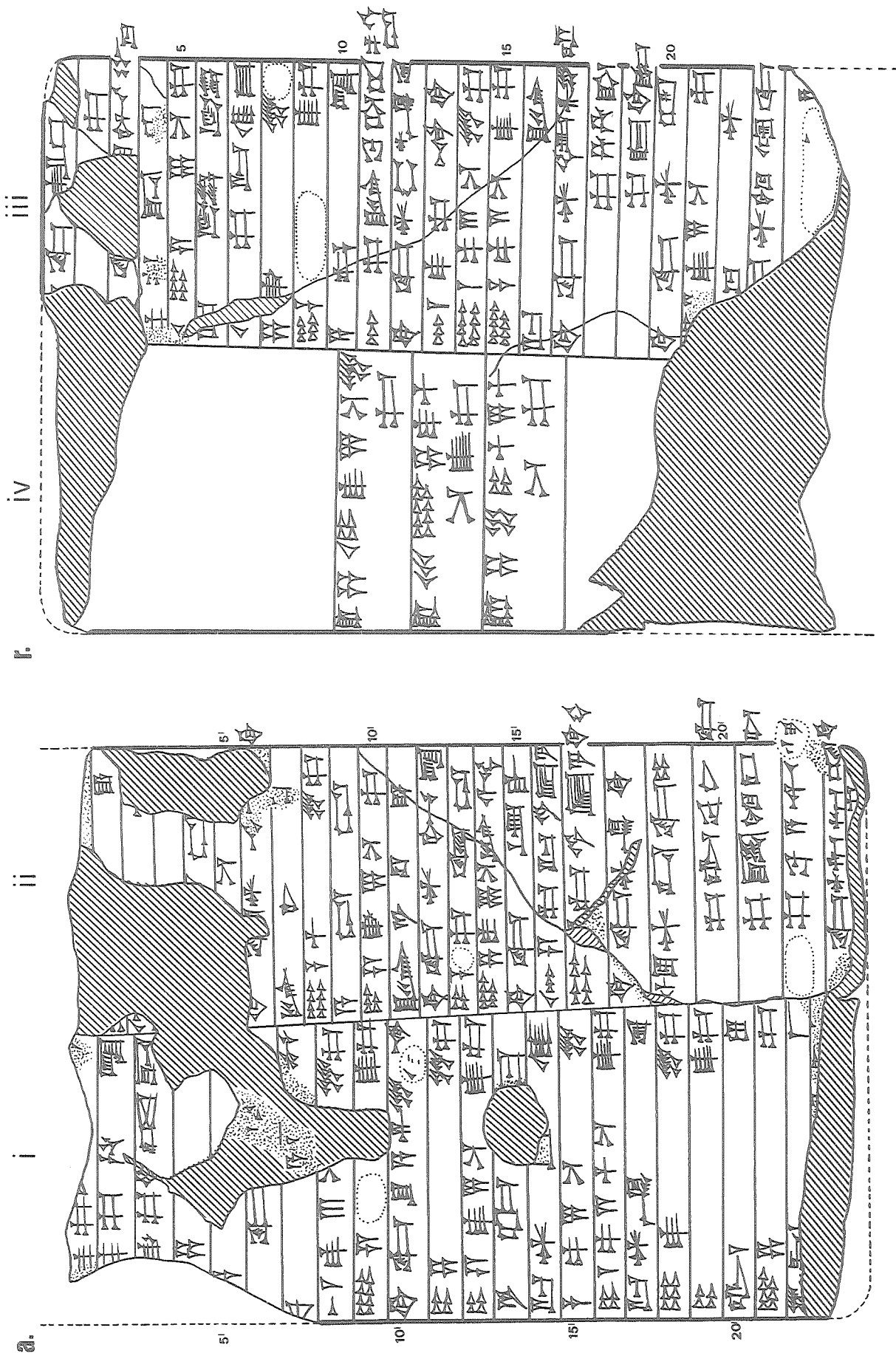

331 (MM 199)

AnOr 7 331
Umma
[]

Perdida aprox. media tablilla
(serrada con fines comerciales)

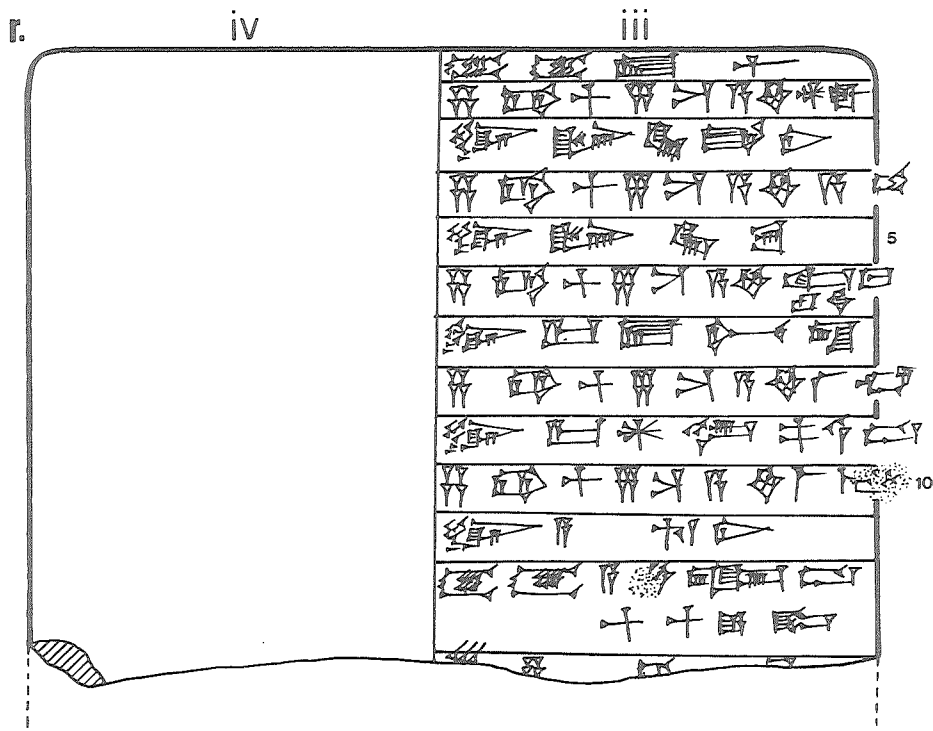
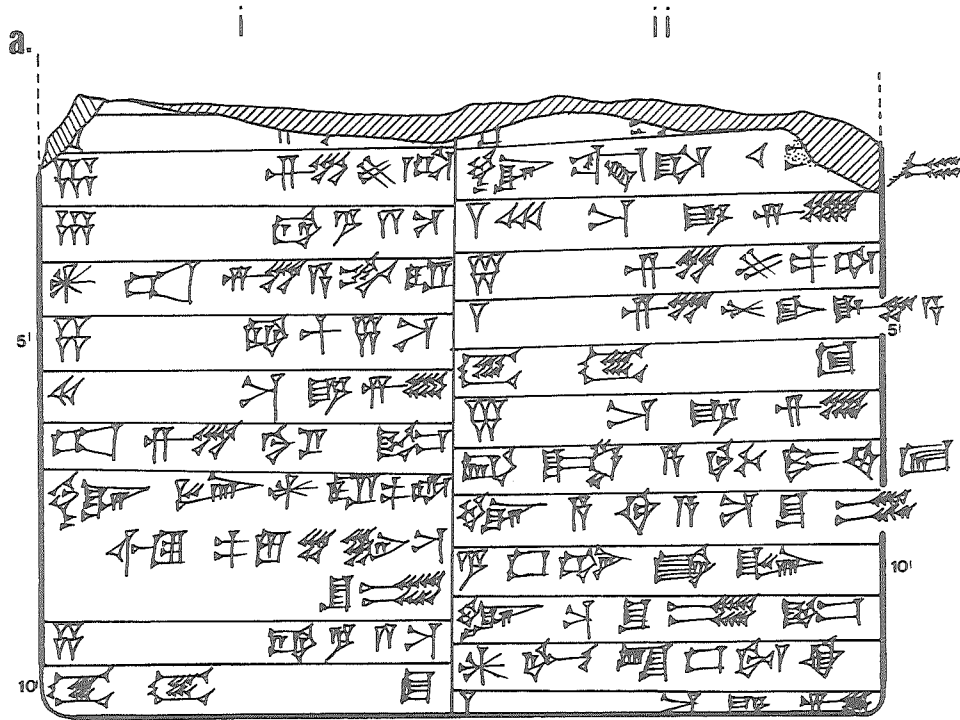

332 (MM 204+208)

AnOr 7 332 (MM 204)

AnOr 7 333 (MM 208)

Umma?

[]

Perdida aprox. media tablilla

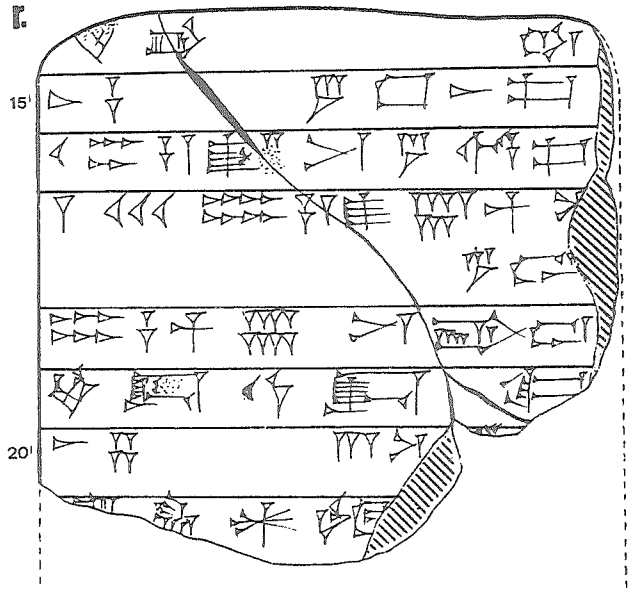
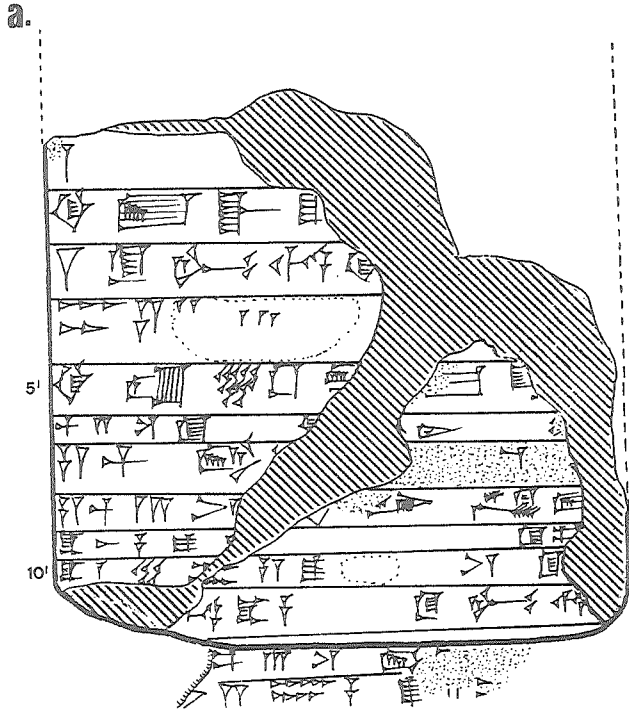

334 (MM 386)

AnOr 7 334

Umma?

[]

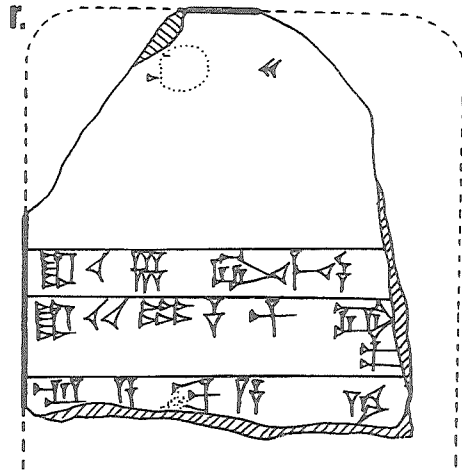
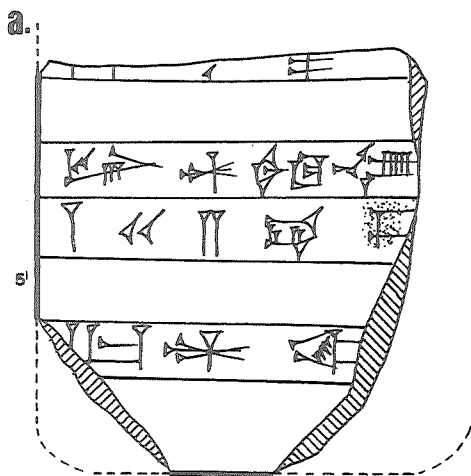

335 (MM 395)

AnOr 7 335
 Umma
 []

335. Sello:

⁴Sara₂-kam
 dub-sar
 dumu Lugal-⁶kiri₂

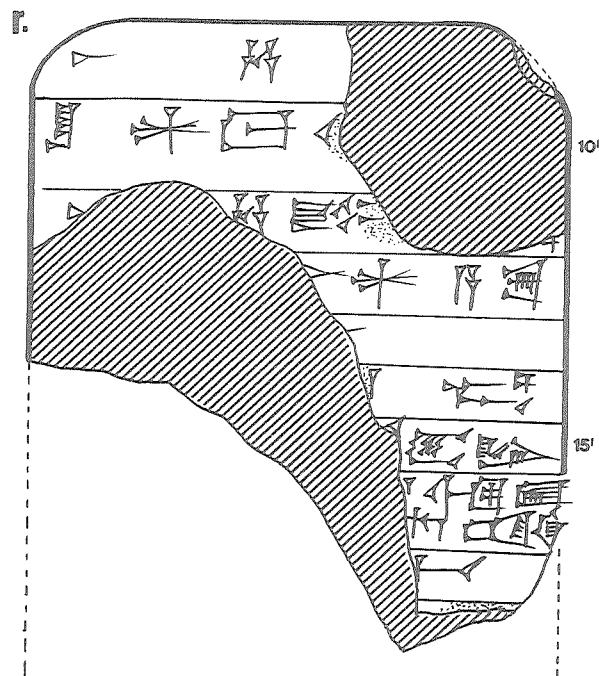
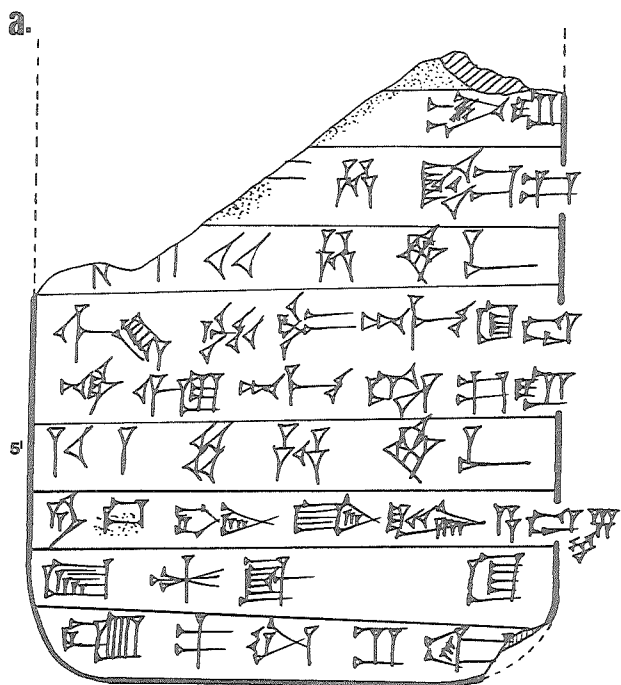

336 (MM 396)

AnOr 7 336
 ?
 [] {AS1}

Reverso destruido

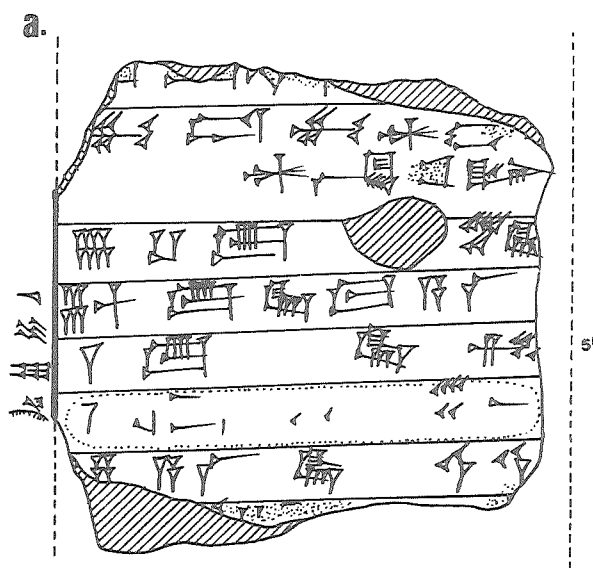

337 (MM 399)

AnOr 7 337
Umma
[]

Perdida aprox. media tablilla

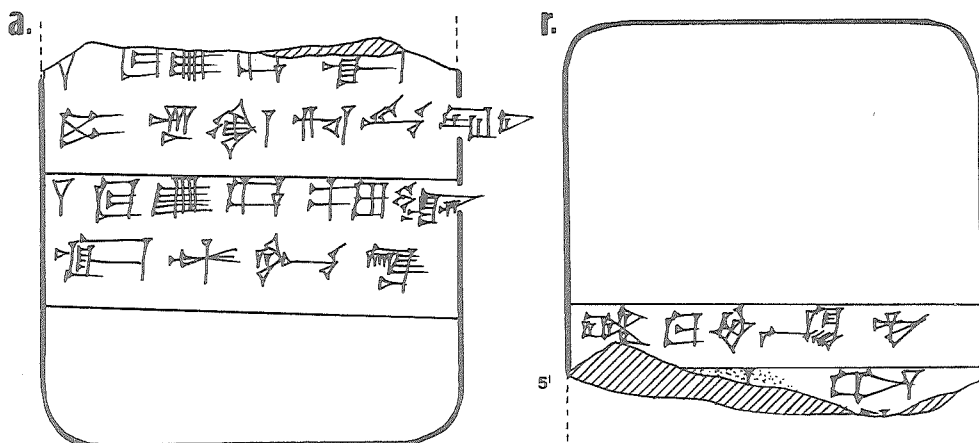

338 (MM 142)

AnOr 7 338
Umma
ŠS6/v/-

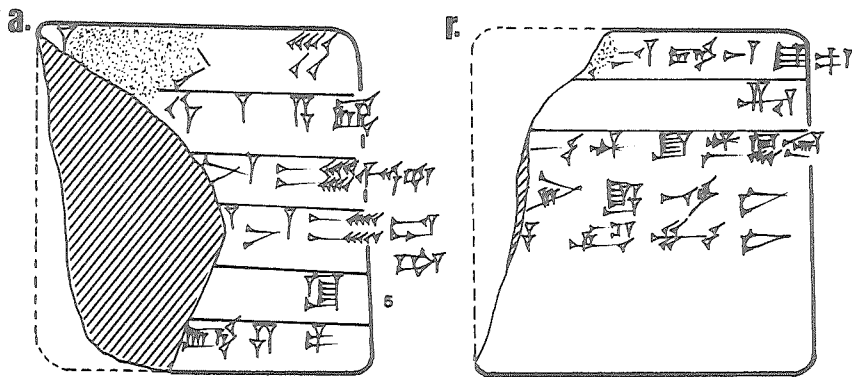

339 (MM 183)

AnOr 7 339
Umma
ŠS2 6 3/-

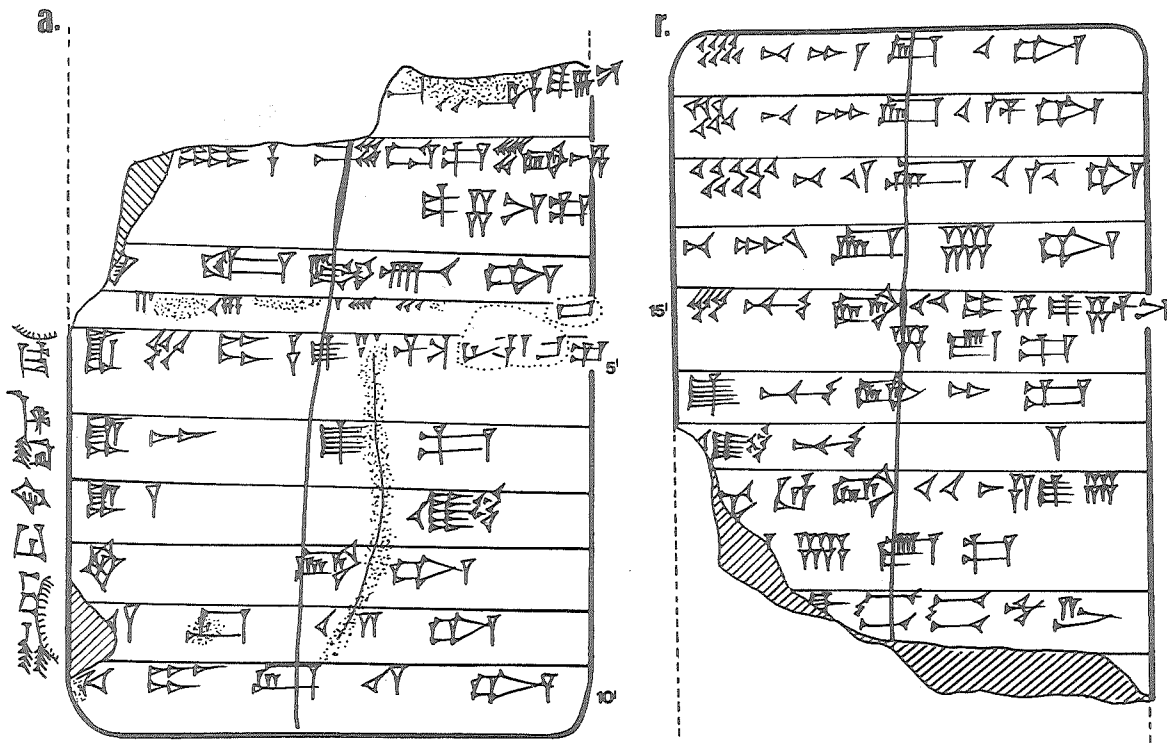

340 (MM 372)

AnOr 7 340
Umma
[]

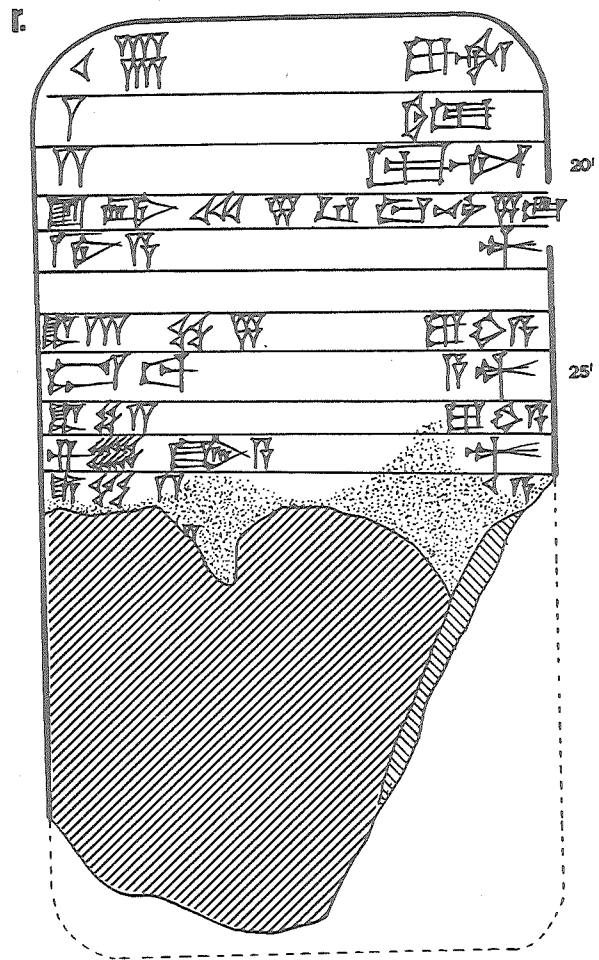
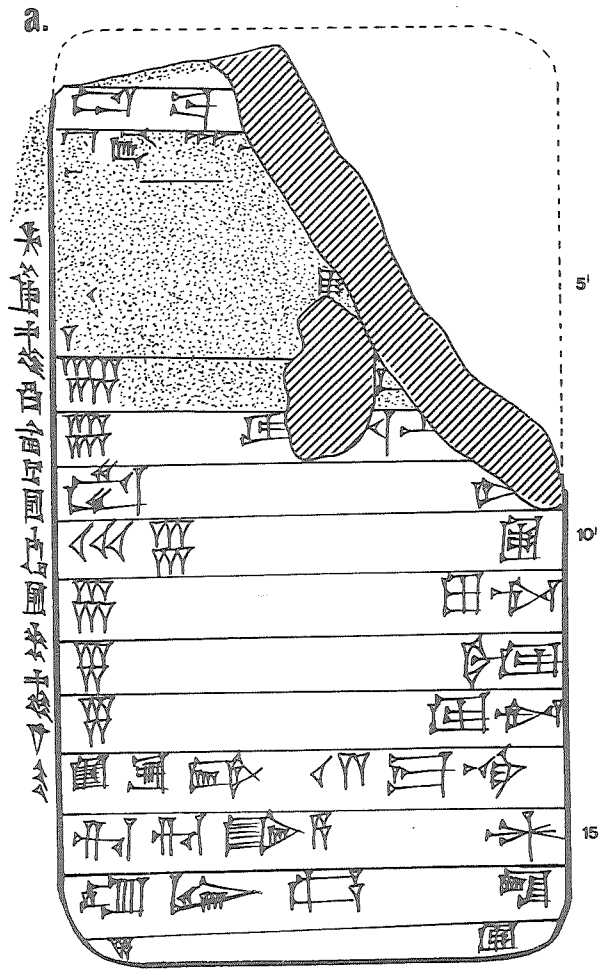

341 (MM 415)

AnOr 7 341
Umma
[]

341. Sello:

Ur-[³Sara₂]
dub-s[ar]
dumu Lugal-[nanga]

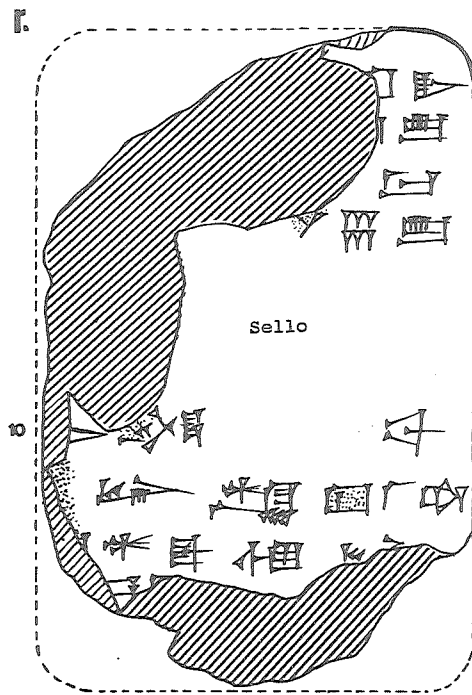
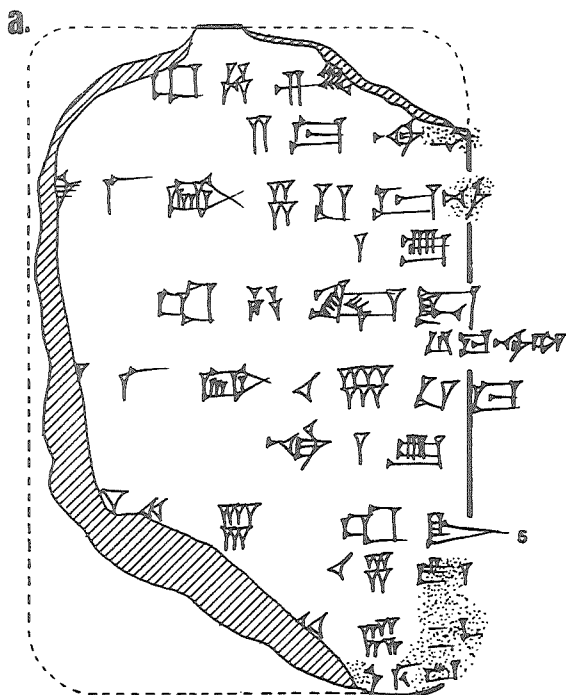

342 (MM 426)

AnOr 7 342
Umma
[]

Perdido aprox. 1/4 de la tablilla

342. Sello:

- i ^dŠu^{-d}Suen
lugal kal-ga
lugal Uri^{ki}-ma
lugal ^dUb-/da limmu₂-ba
- ii ^rA-a⁻[kal-la]
ensi₂
Umma^{ki}
arad₂-zu

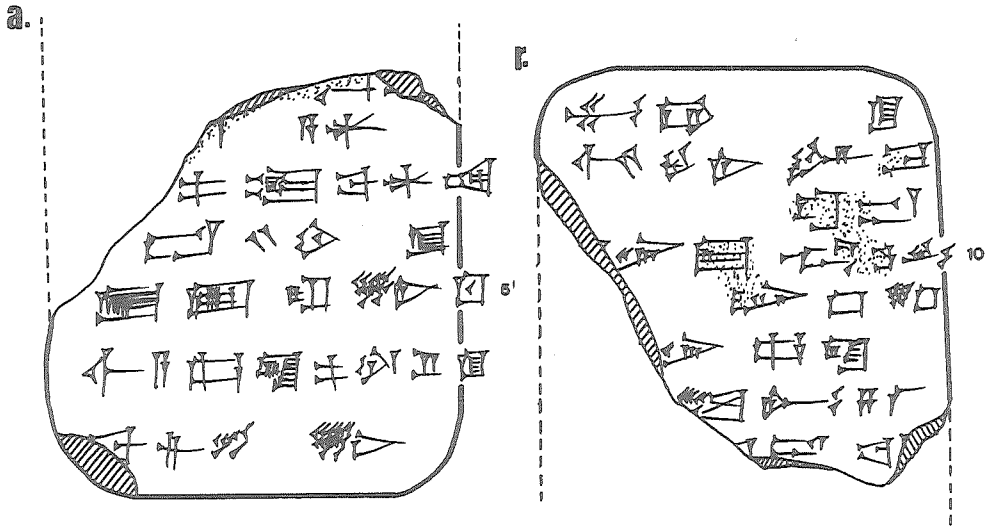

344 (MM 430)

AnOr 7 344
Umma
AS5/[]

Perdido aprox. 1/3 de la tablilla

344. Sello:

- [...]
- du[b-sar]
- dumu Šeš-[...]

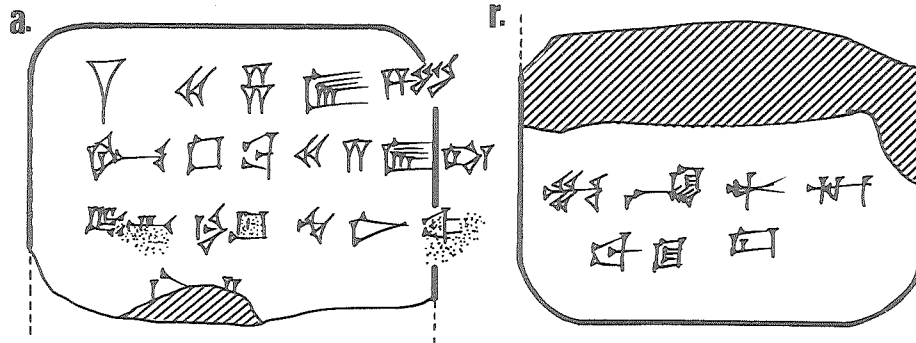

345 (MM 429)

AnOr 7 345
Umma
[]

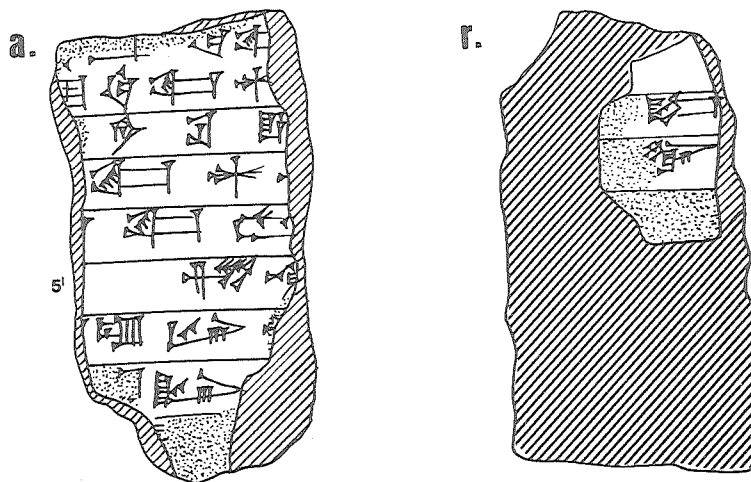

343 (MM 364+374+427+658+843+933)

AnOr 7 343 (MM 427)

AnOr 7 357 (MM 364)

Umma

[]

Reverso destruido

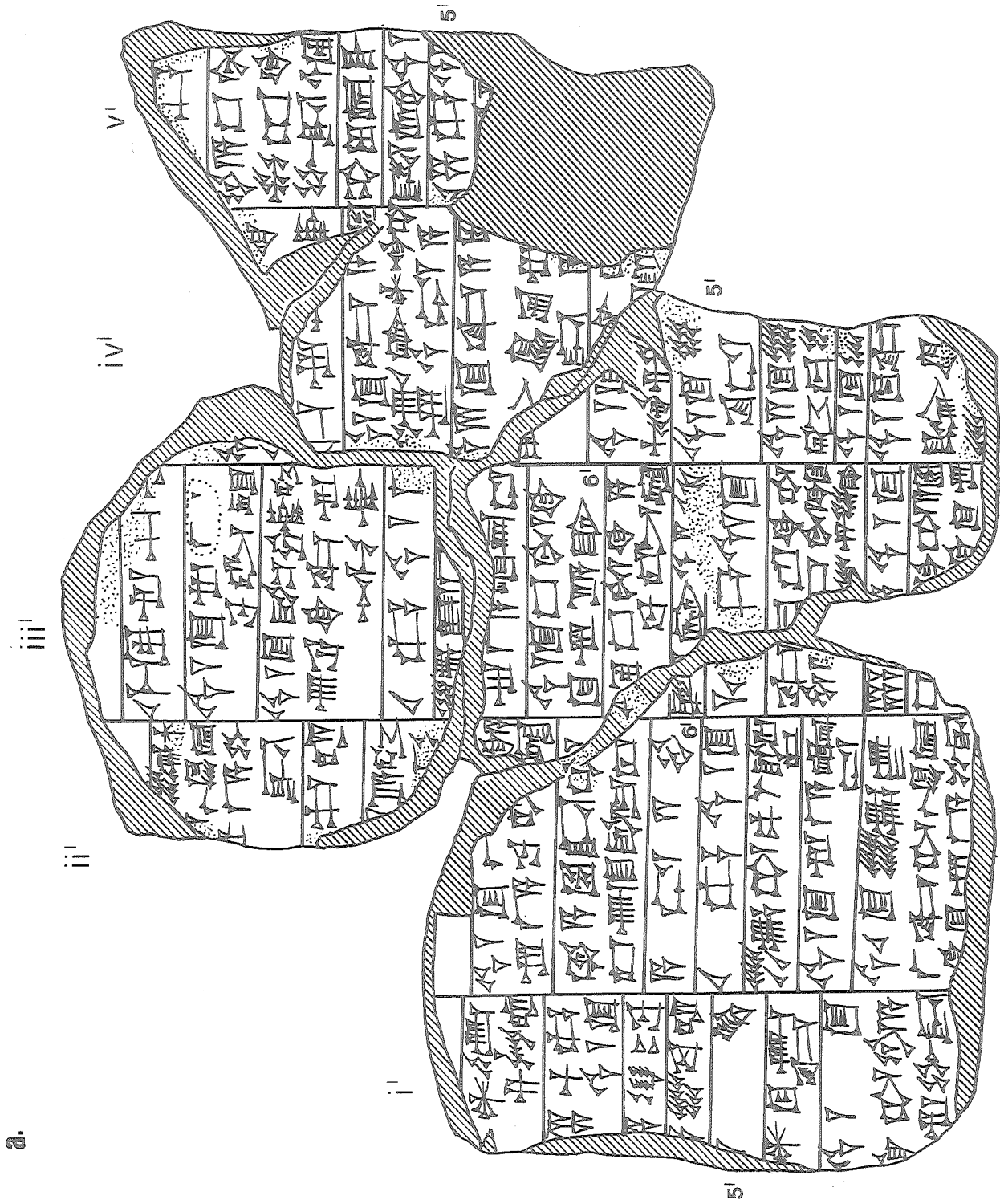

346 (MM 433)

AnOr 7 346
Drehem
AS5/[]

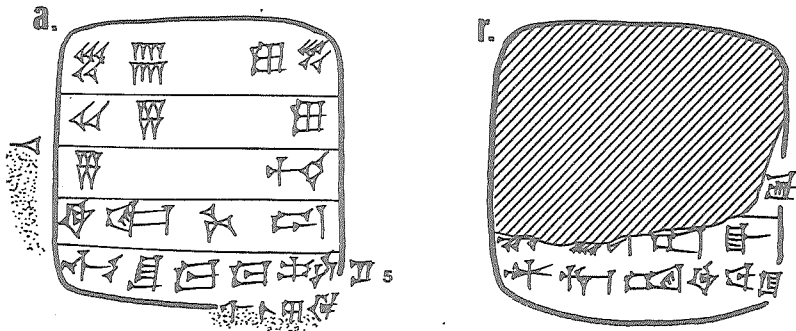

348 (MM 592)

AnOr 7 348
Umma
[]

348. Sello:

[...]
dub-sar
dumu Kur₄-sa₃-an

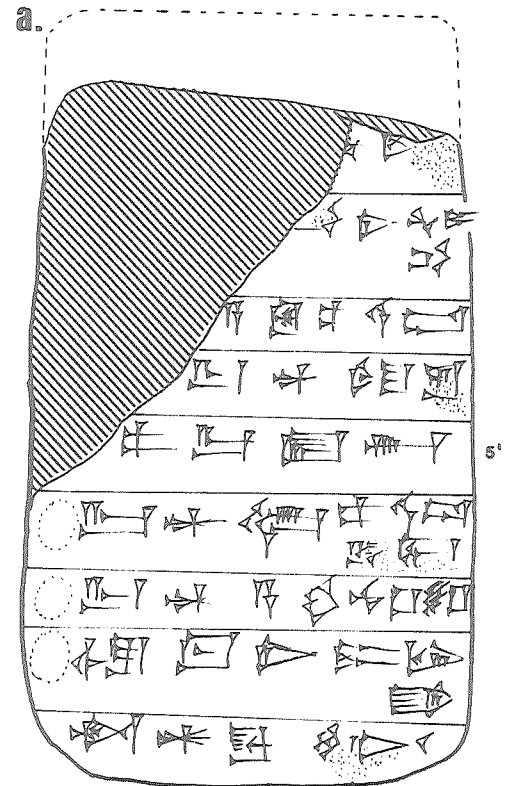

347 (MM 438)

AnOr 7 347
Umma
Š441/-

347. Sello:

Ur^d-Li₂-si₄
ensi₂ Umma^{ki}
Lugal^{ab}-gigir-re
dub-sar
[...]

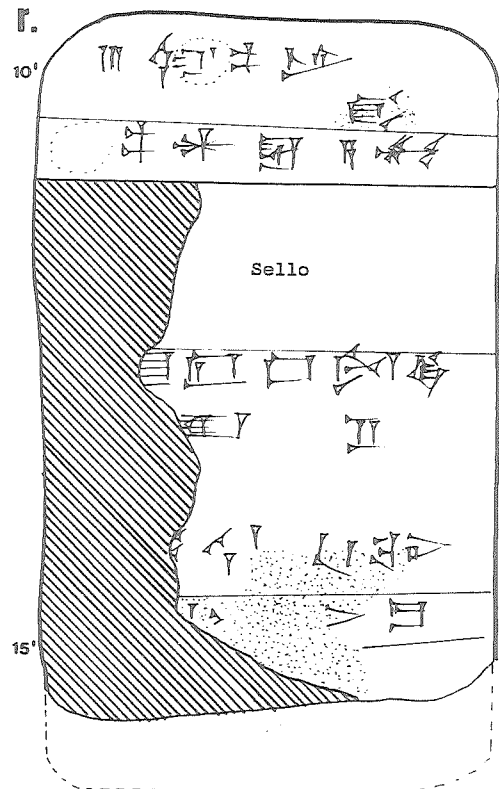
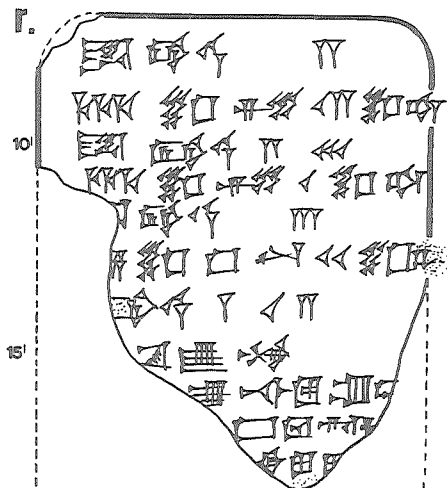
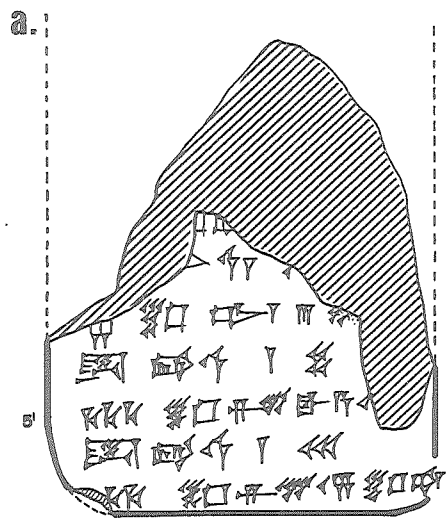

349 (MM 561)

349. Sello:

AnOr 7 349
Umma
Š44/vii/-

- i A-kal-[la]
dub-sar
- ii dumu L[ugal]-/ne[sag₂-e]

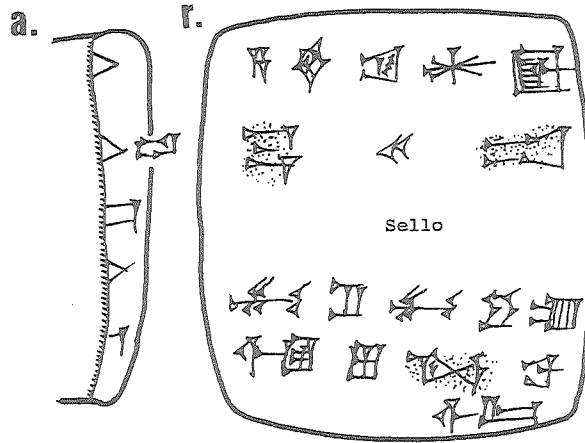

350 (MM 449)

AnOr 7 350
Umma
AS7/x/7

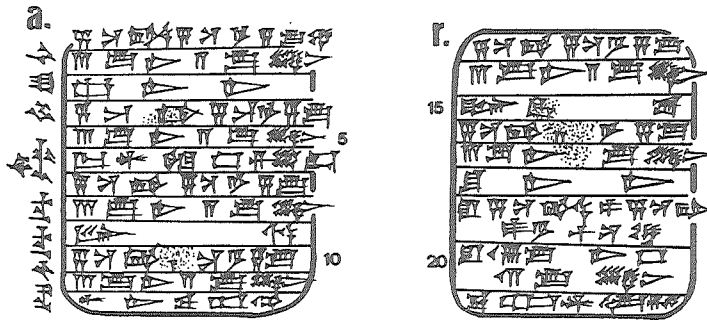

351 (MM 350)

351. Sello:

AnOr 7 351
Umma
ŠS8/iii/10[(+x)]

- i ^oSu-^oSuen
lugal kal-ga
lugal Uri,^{ki}-ma
lugal ^oUb-/da limmu,-ba
- ii Gu-du-du
dub-sar
dumu Da-da-[ga]
arad,-[zu]

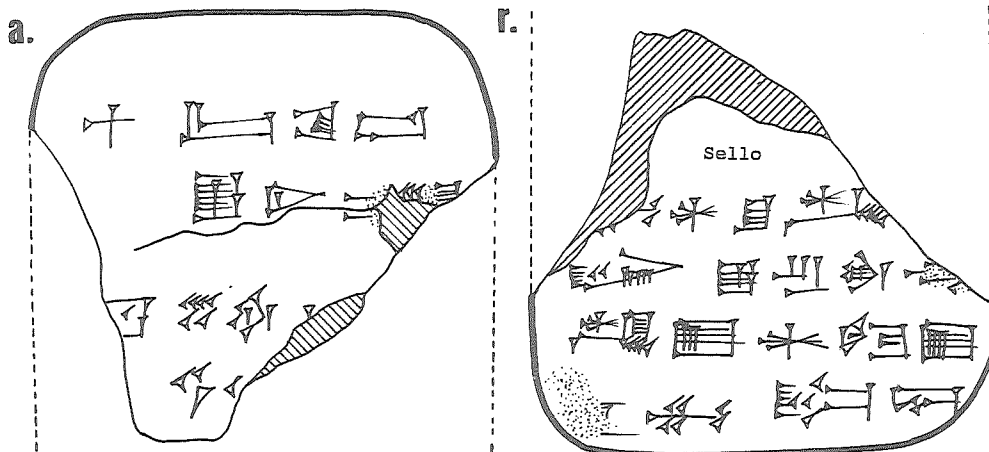

352 (MM 333)

AnOr 7 352
 Umma
 ŠS2/-/- {i,iv,vi,viii,[]}

352. Sello:

- i Šu-^dSuen
 lugal kal-ga
 lugal Uri,^{ki}-ma
 lugal ^dUb-/da limmu₂-ba
- ii A-a-kal-la
 ensi₂
 Umma^{ki} /arad₂-zu

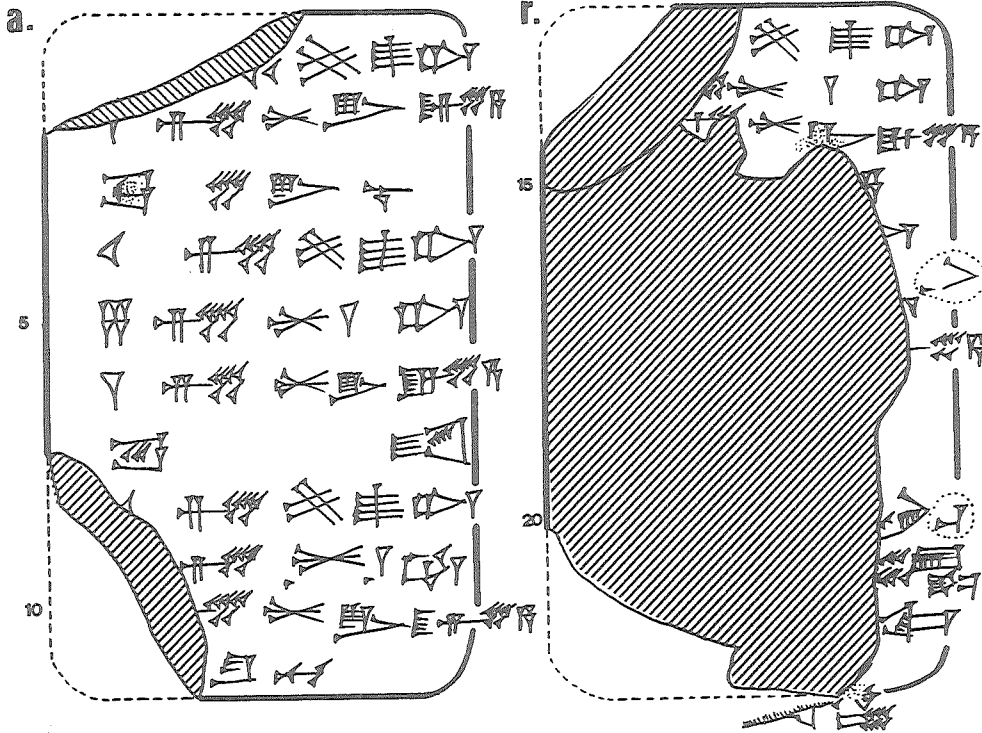

353 (MM 370)

AnOr 7 353
 ?
 []

Reverso destruido

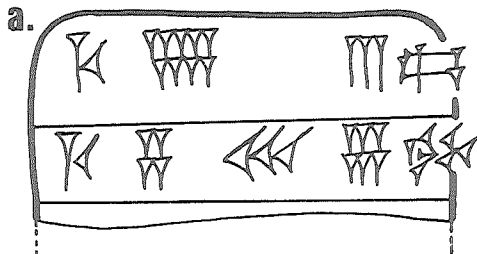

354 (MM 351)

AnOr 7 354
Umma
[]

Medidas originales aprox. de la tablilla
70 x 100 mm y dos columnas por cada cara

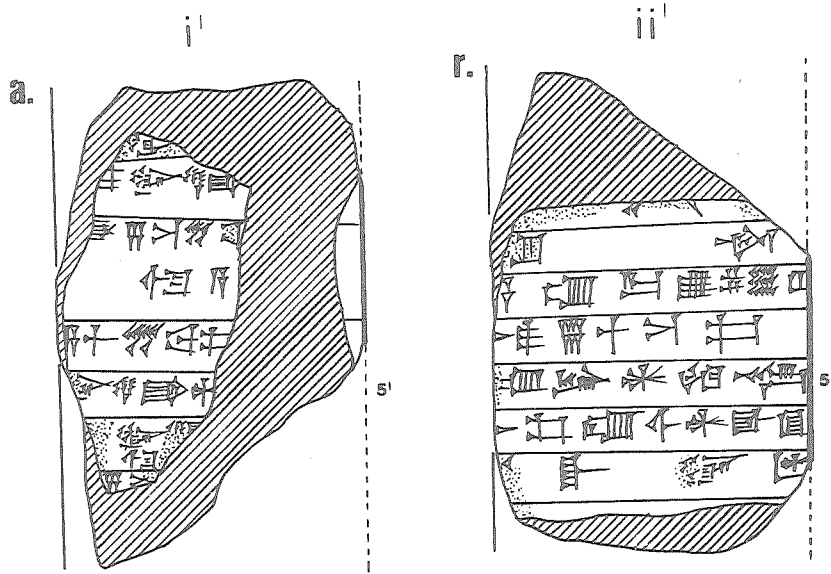

355 (MM 352)

AnOr 7 355
Lagaš?
[]

Reverso destruido

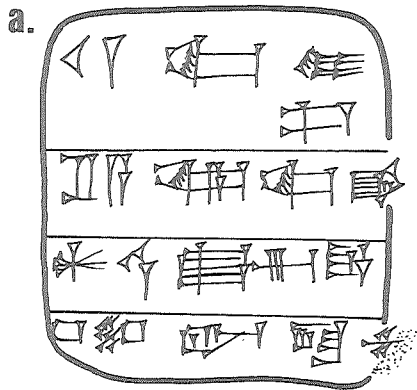

356 (MM 361)

AnOr 7 356
Umma?
ŠS4/x-

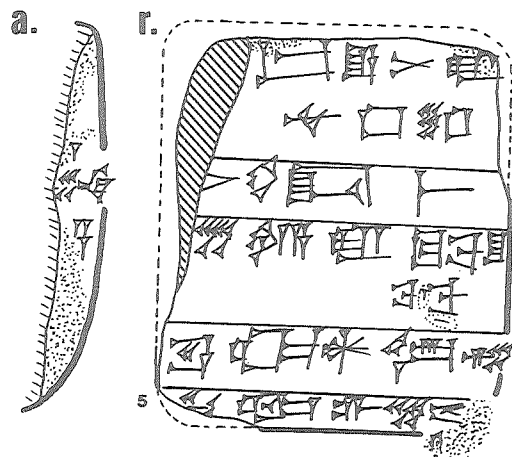

358 (MM 366)

AnOr 7 358
Umma?
[]

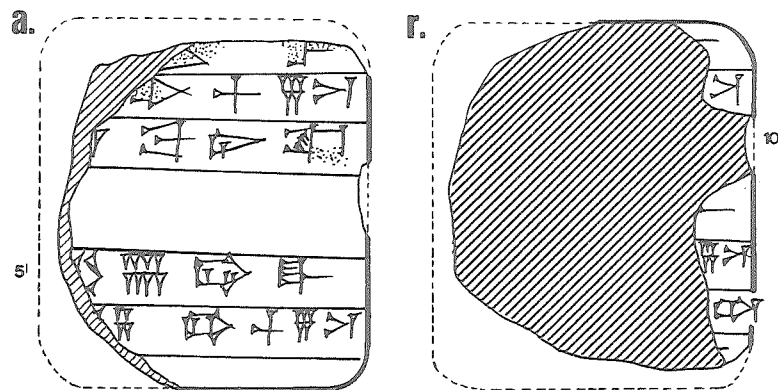

AnOr 7 359
Lagaš
[]

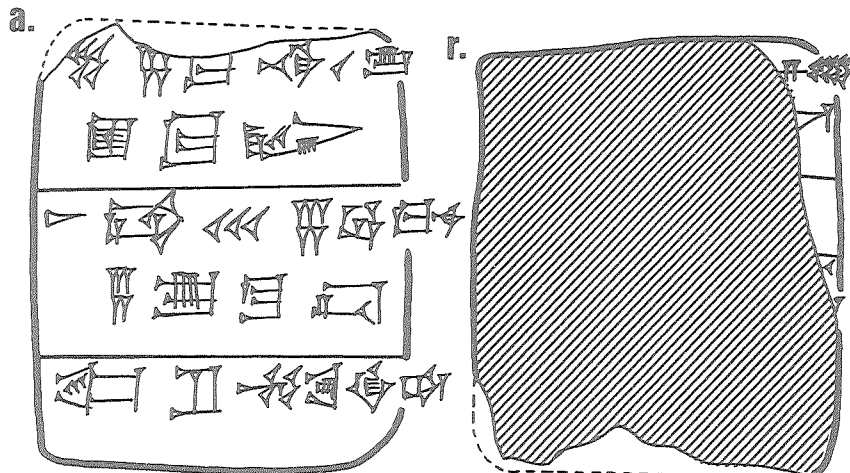

360 (MM 371)

AnOr 7 360
Umma
-/-

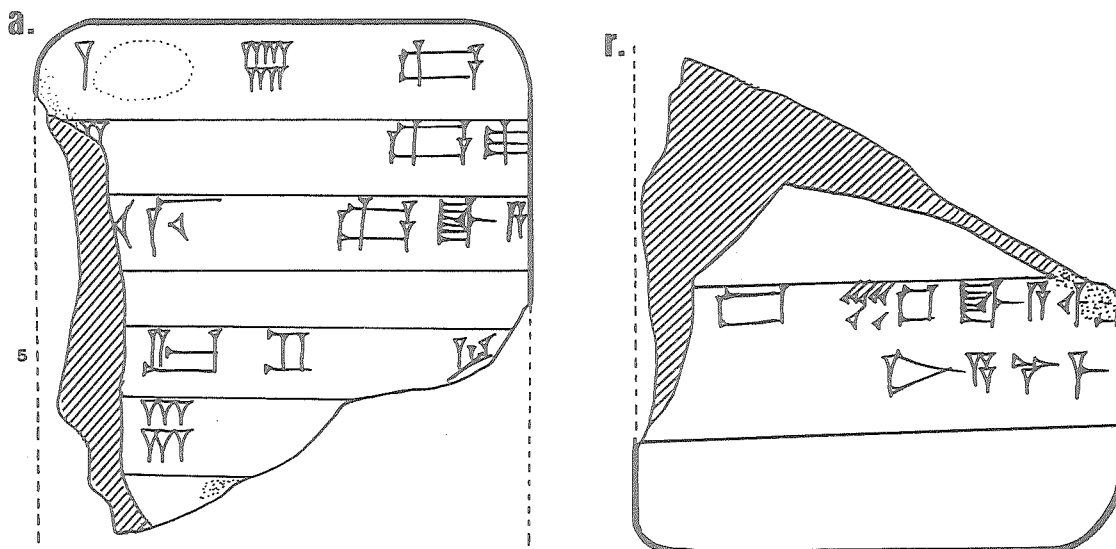

361 (MM 382)

AnOr 7 361
Umma
AS2/[]

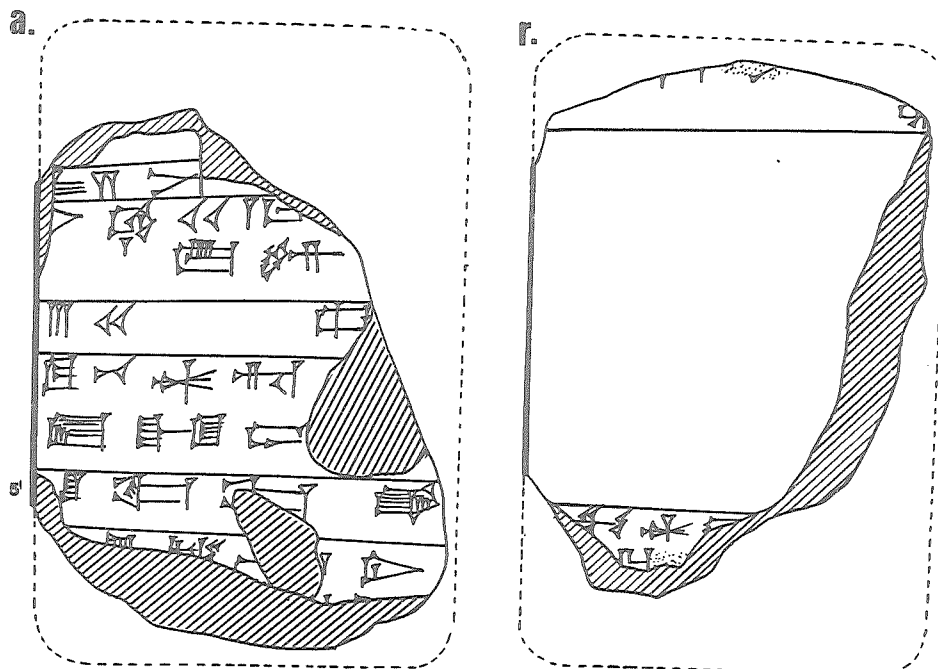

362 (MM 334)

AnOr 7 362
Umma
[]

Reverso destruido

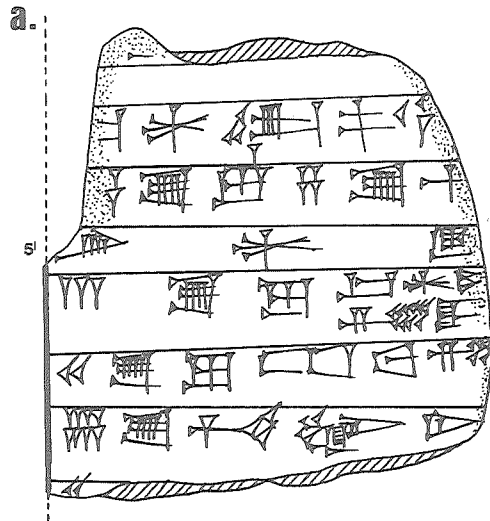

363 (MM 335)

AnOr 7 363
?
[]

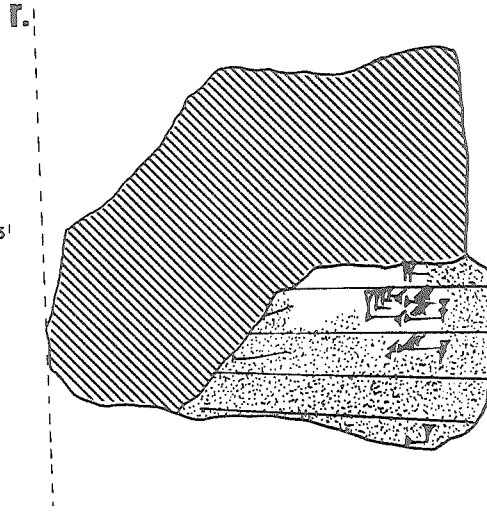
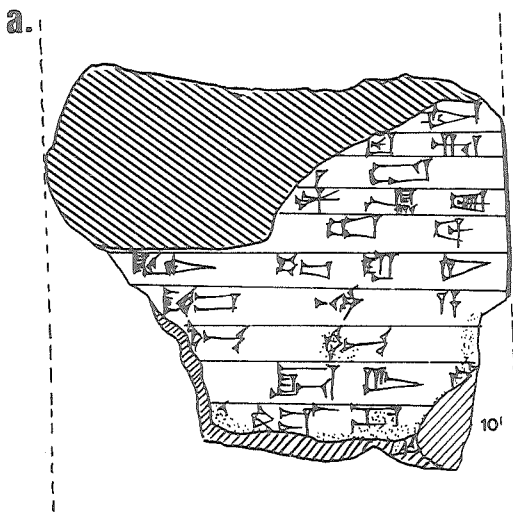

364 (MM 342)

AnOr 7 364
Umma
ŠS3/v/-

364. Sello:

Lu₂-kal²-la
dub-[sar]
dumu Ur-[e₁₁-e k]uš,

Impresiones de tejido sobre el sello y en anverso

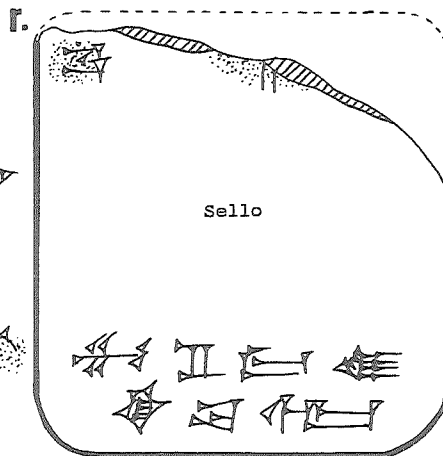
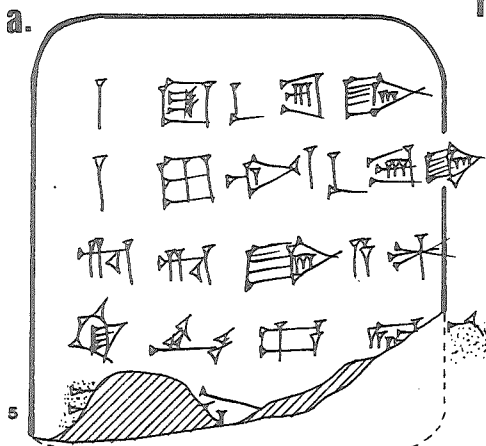

365 (MM 347)

365. Sello ilegible

AnOr 7 365
Umma
AS8/-/

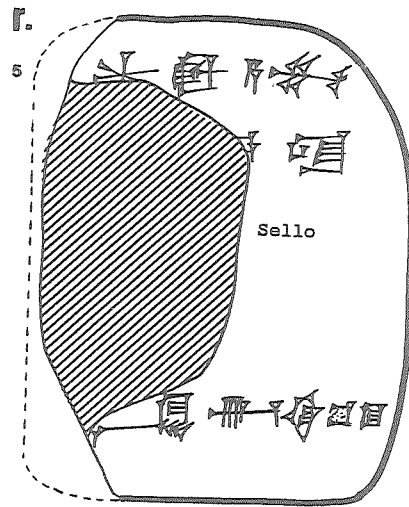
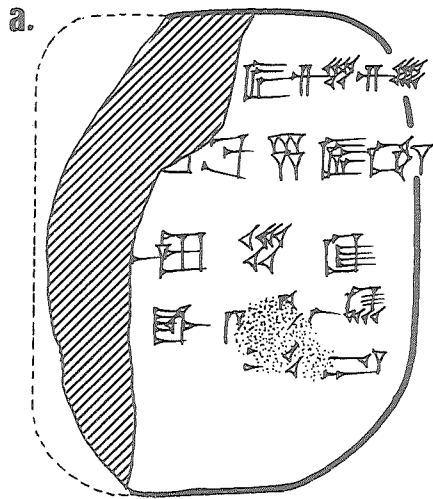

366 (MM 520)

366. Sello:

AnOr 7 366
Umma
[]

I-ti-šu- [...]
lu₂ [...]
dumu I-la- [..]

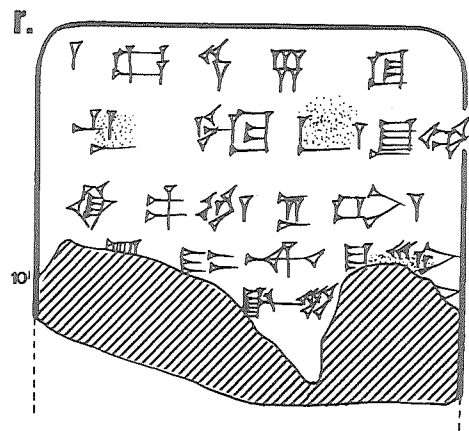
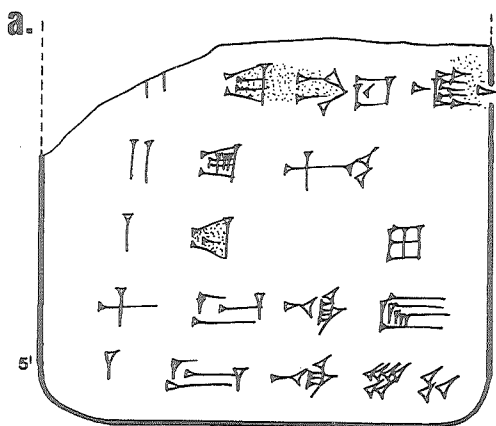

367 (MM 557)

367. Sello:

AnOr 7 367
Umma
ŠS4/-/

Lu₂-[Šara₂]
dub-sar
dumu Ur-ša₆-ga

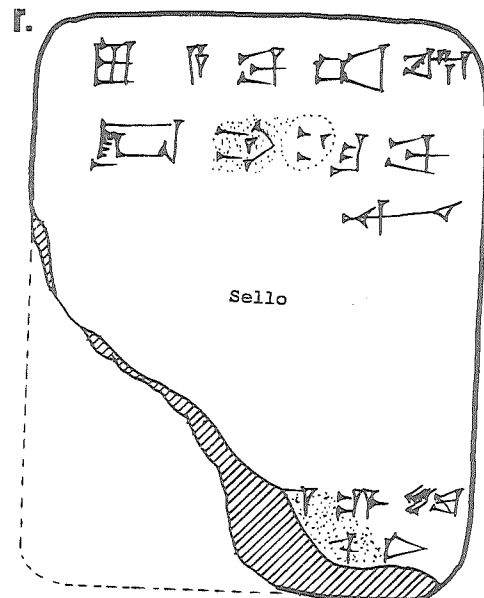
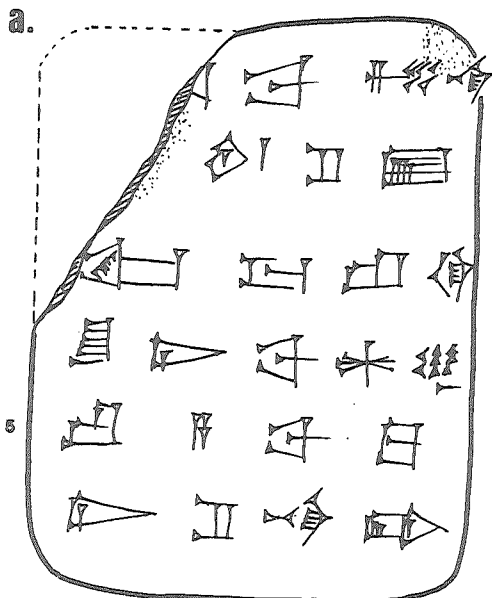

368 (MM 568+798)

AnOr 7 368 (MM 568)
 Umma
 [entre Š48-ŠS1]

368. Sello:

Inim-Šara₂
 dub-sar
 dumu Ur-ni₉-gar

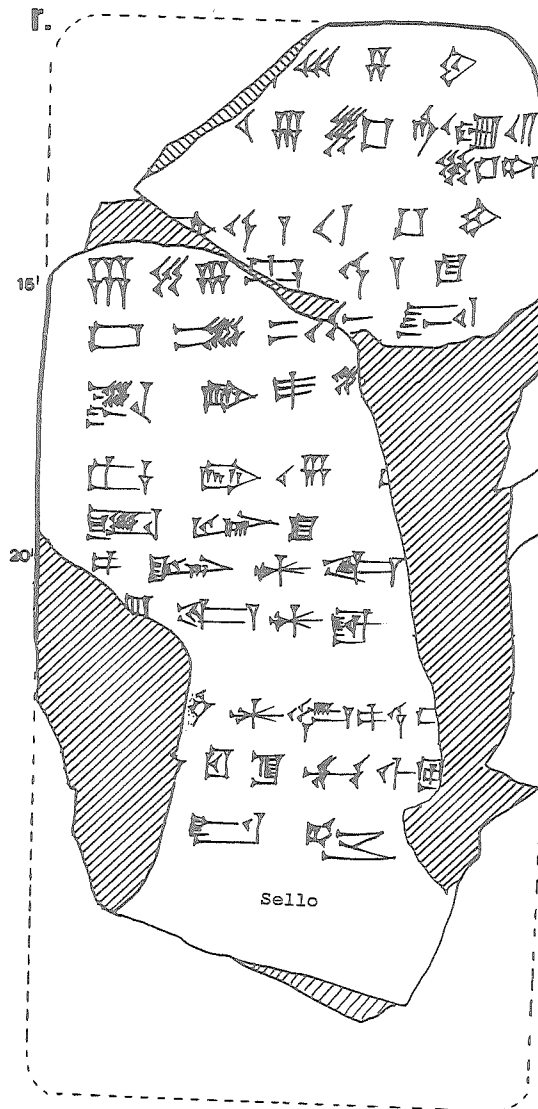
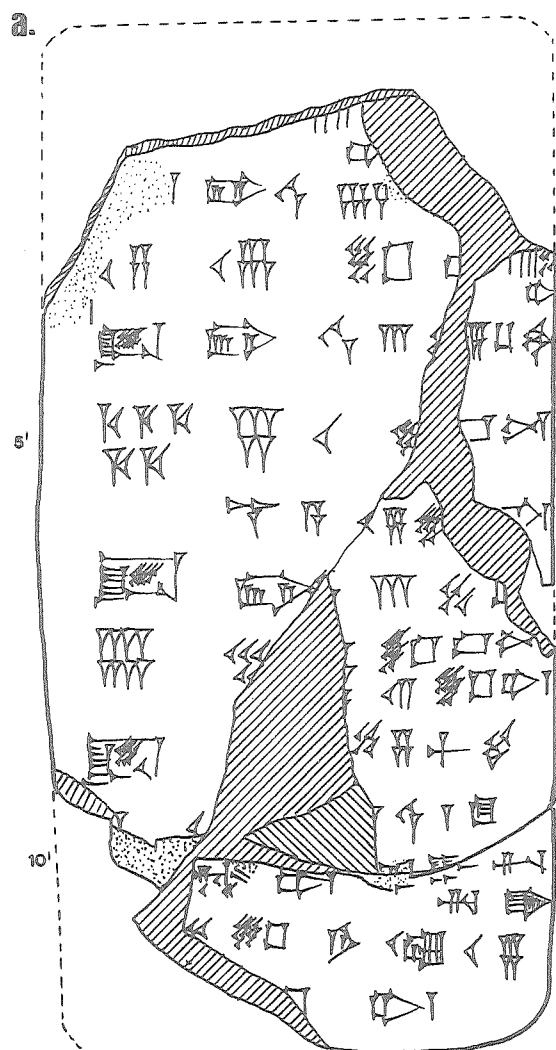

369 (MM 574)

AnOr 7 369
 Umma
 ŠS4/xii/-

369. Sello:

Lugal-[nir]
 dub-sar
 dumu Ur-Šara₂
 ša₁₃-dub-ba-ka

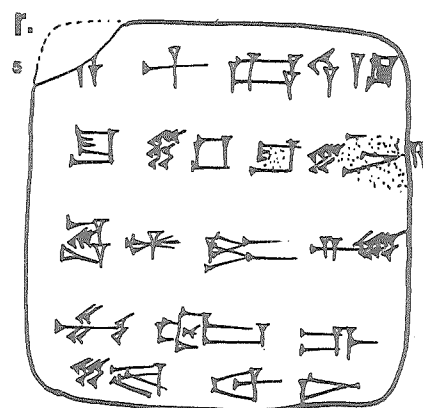
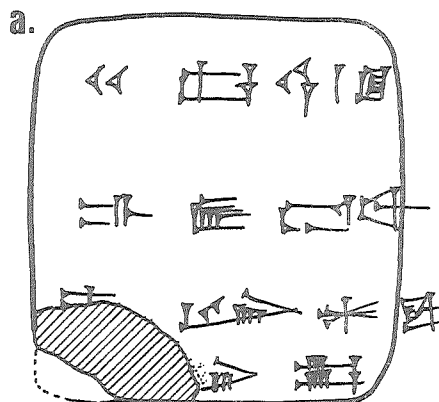

370 (MM 584)

AnOr 7 370
Umma
Š48/-/-

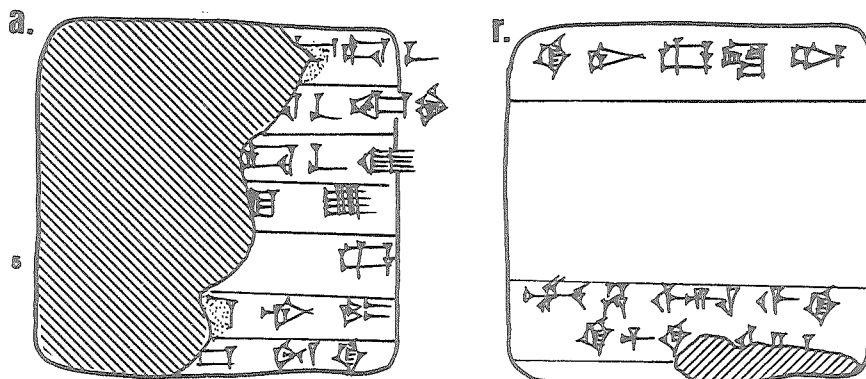

371 (MM 200)

AnOr 7 371
Umma
-/-/-

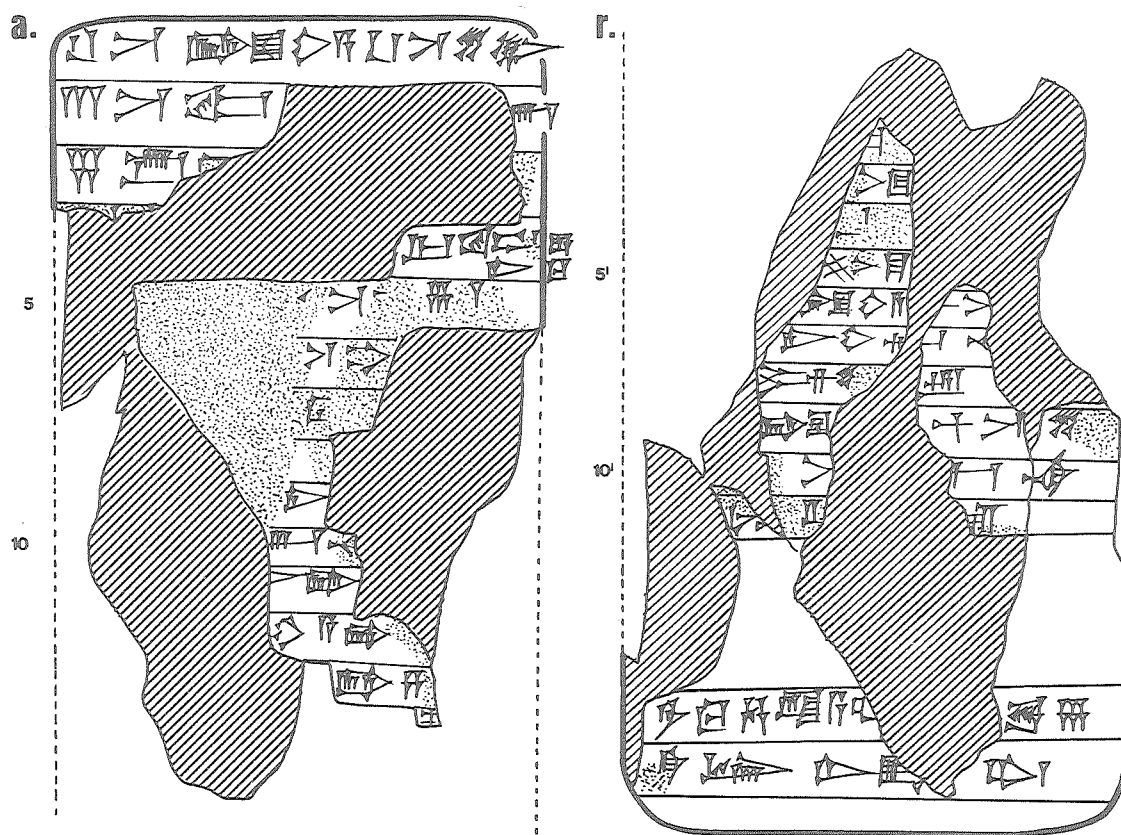

373 (MM 122)

AnOr 7 373
Umma
ŠS3/v/-

373. Sello:

Lu₂-⁴Ha-ia₃
dub-sar
dumu Ur-e₁₁-e kuš,

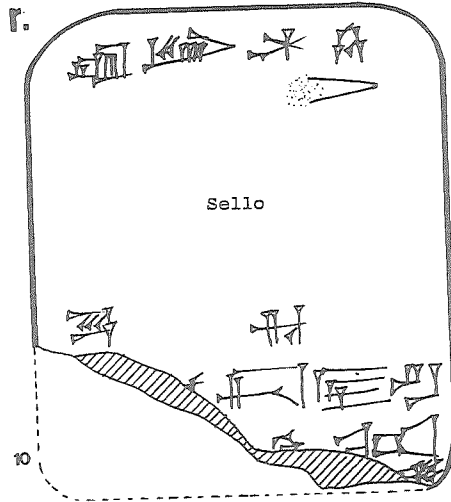
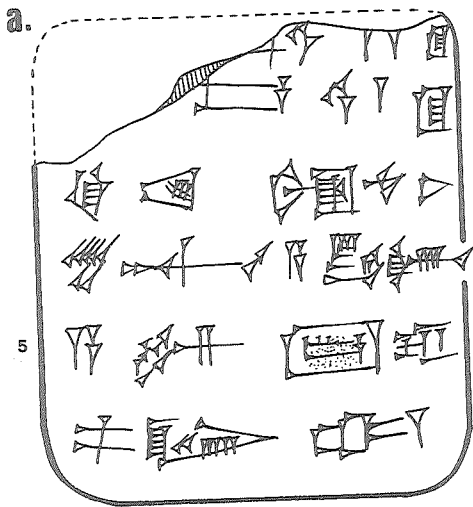

374 (MM 196)

AnOr 7 374
Umma
[]

Tablilla originalmente con ocho columnas
por cada cara (serrada con fines comerciales)

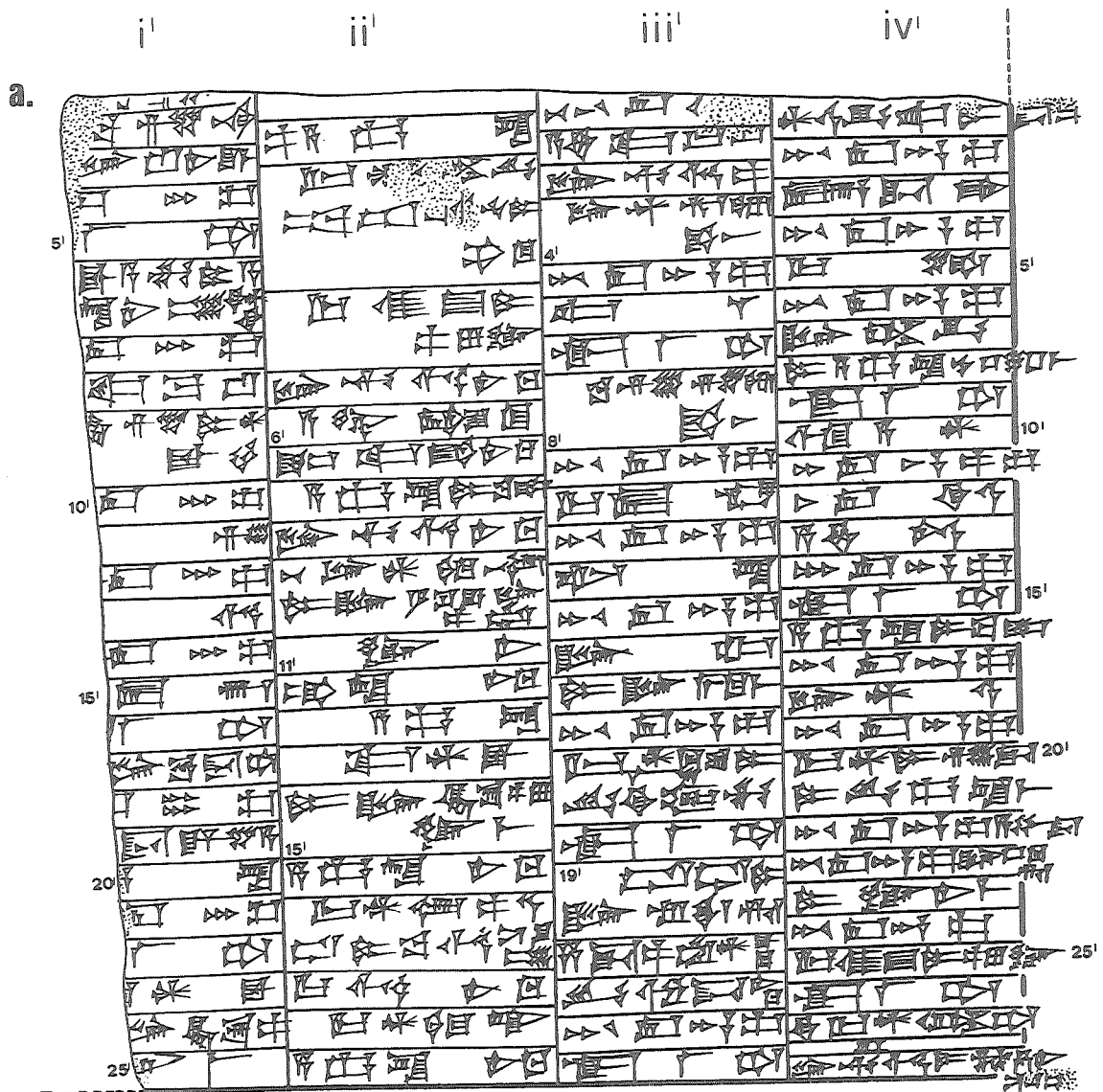

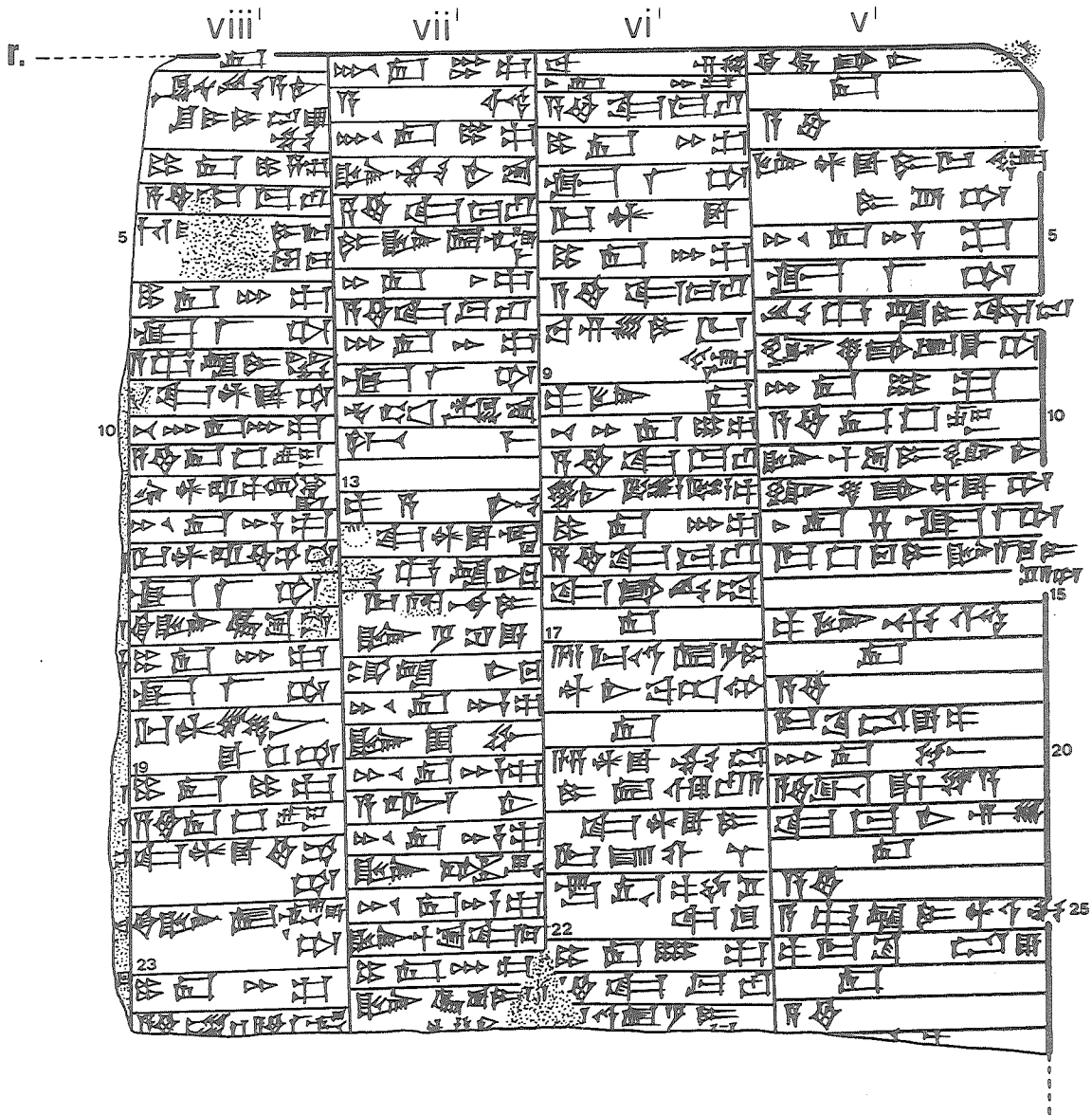

375 (MM 189)

a.

AnOr 7 375
Umma
[]

Reverso destruido

375. Sello:

Lugal-ma₂-gur₆-r[e]
dumu Lu₂-⁴Sara₂
x x[...]

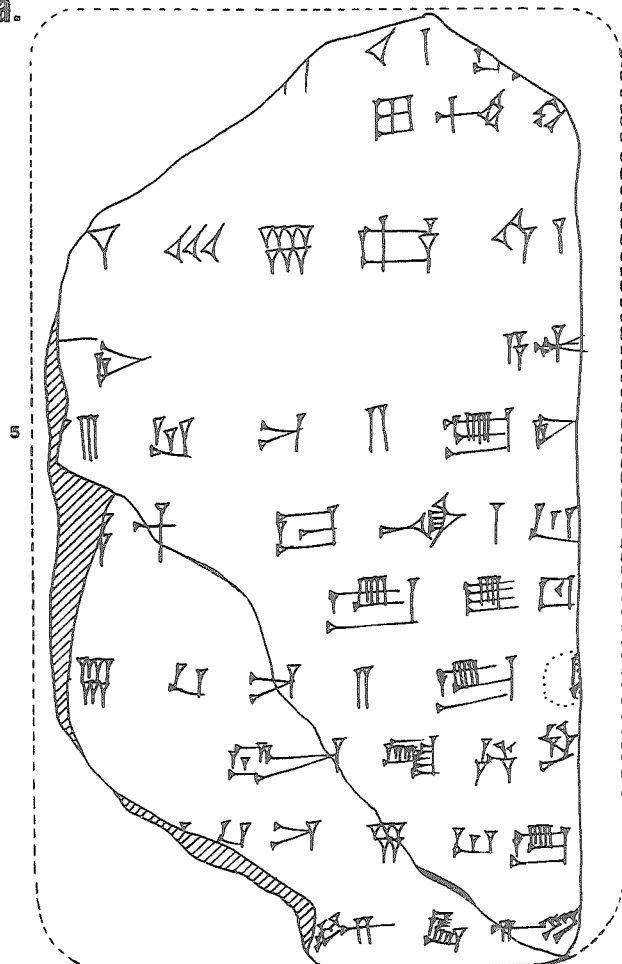

376 (MM 53)

AnOr 7 376
Drehem
IS2/xii/5,22

376. Sello:

Puzur₄-[Eš₄-ta]_{r₂}
aga₃-us₂ lugal
dumu 'Šamaš-mu-da-[...]

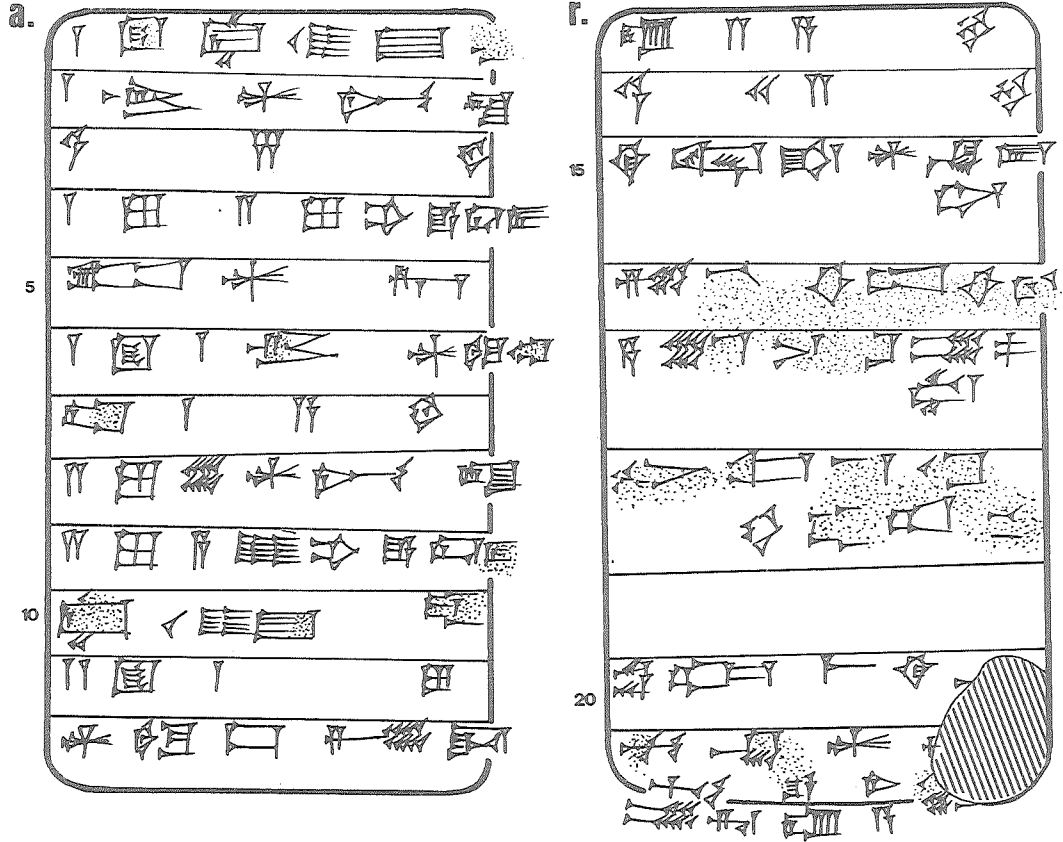

377 (MM 137)

AnOr 7 377
Umma⁷
[] {SS2,4,5,[]}

Reverso destruido

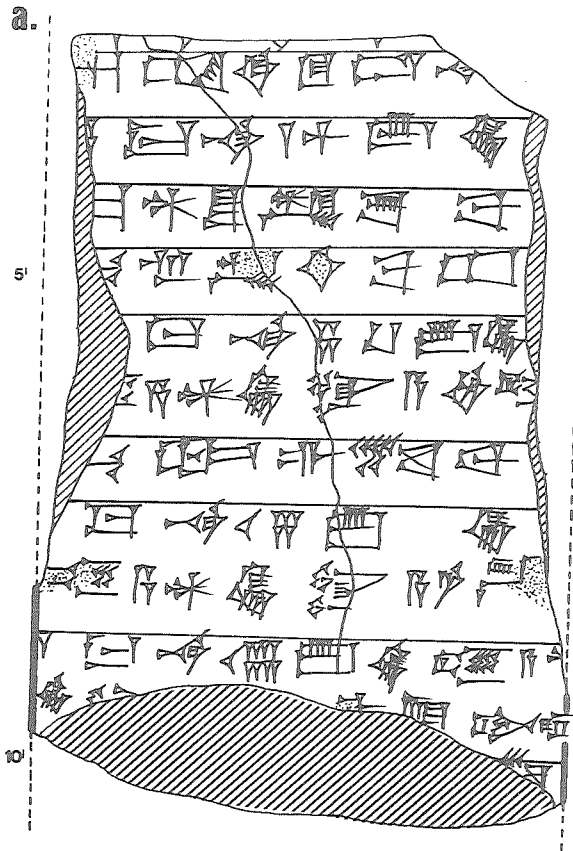

378 (MM 539)

AnOr 7 378
Umma
AS7/-/

378. Sello:

Šeš'-kal-la
dub-sar
dumu A.KA.DUL.[A]

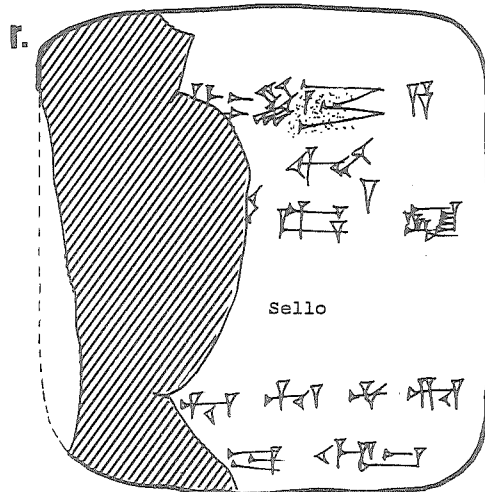
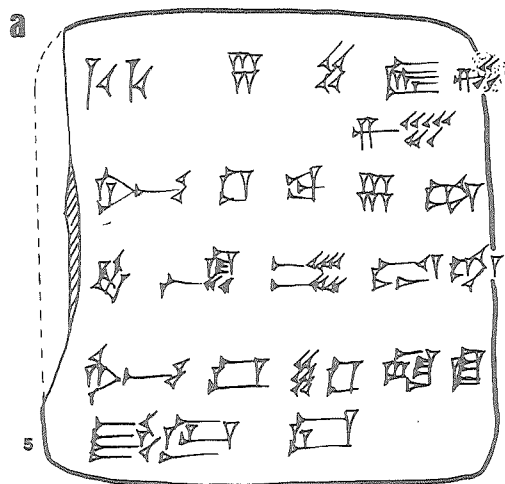

379 (MM 546)

AnOr 7 379
Umma
Š48/-/

379. Sello:

Arad₂-[mu]
dub-sar
dumu Ur-ni₂-gar kuš,

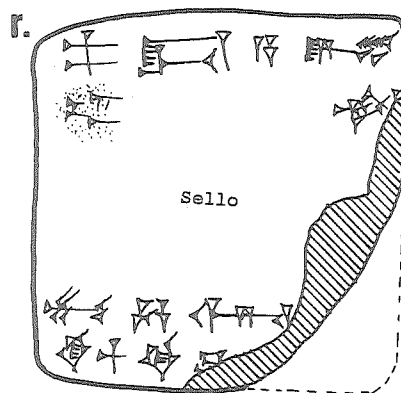
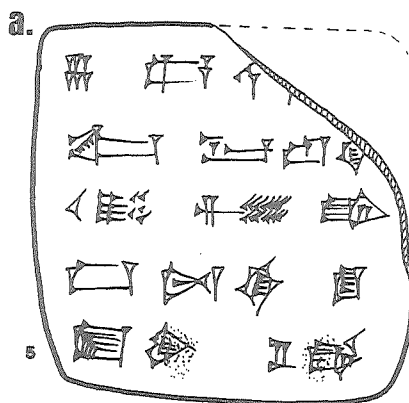

380.1 (MM 528)

AnOr 7 380.1
Umma
AS8/-/

380.1 Sello:

Ur-⁴[Šara₂]
dub-sar
dumu Tab-ša₃-¹u₃-²lu

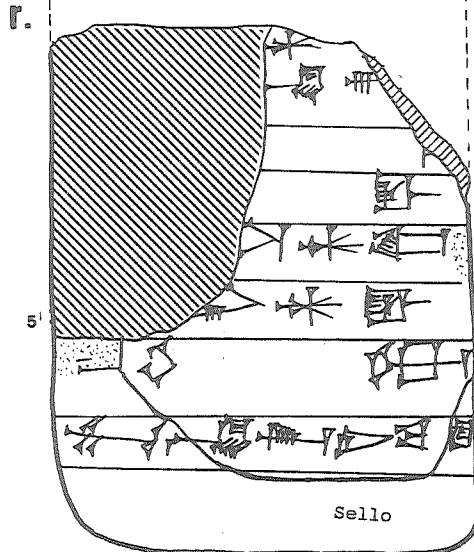
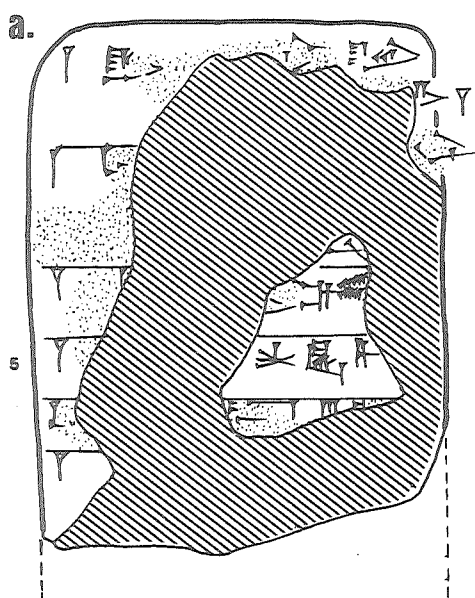

380.2 (MM 531)

AnOr 7 380.2
Umma
AS8/-/

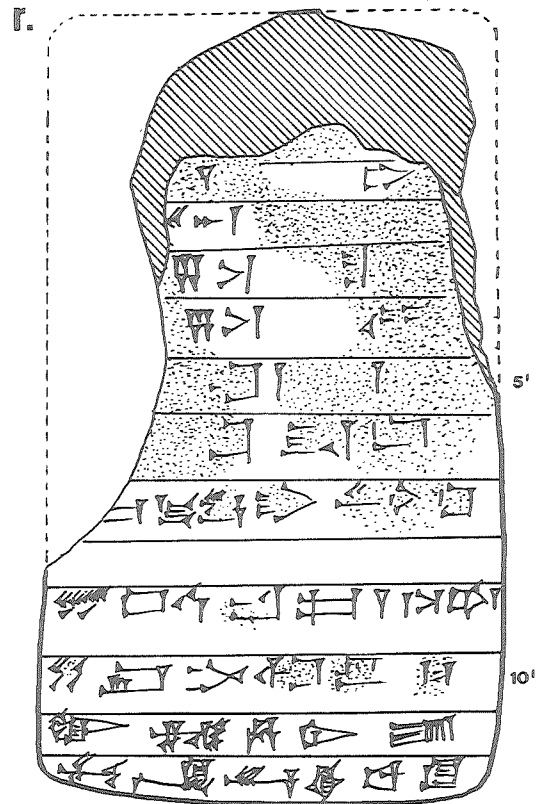
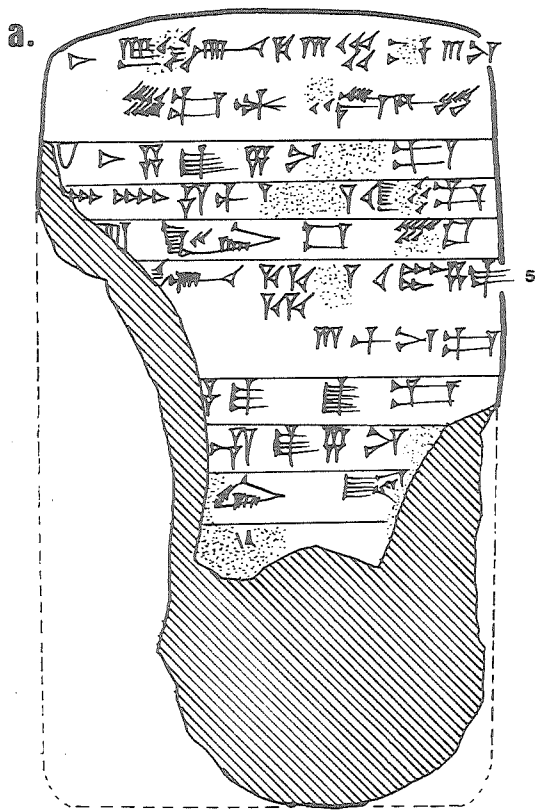

380.3 (MM 576)

AnOr 7 380.3
Lagaš[?]
AS2/iii[?][?]

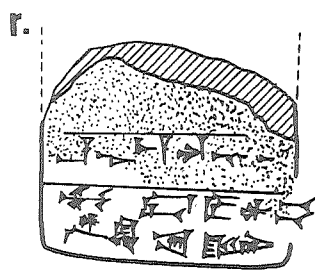
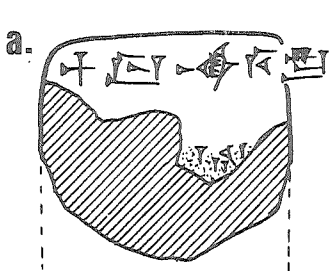

380.4 (MM 209)

AnOr 7 380.4
Lagaš
ŠS5/i/10

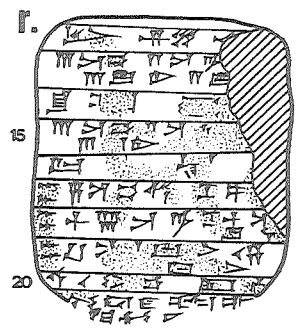
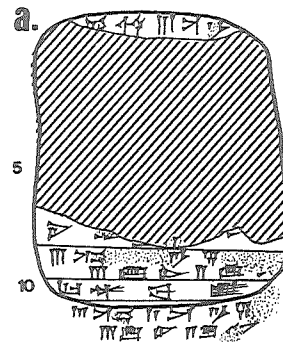

380.5 (MM 363)

AnOr 7 380.5
Umma
[]

Reverso parcialmente destruido y anepigráfico

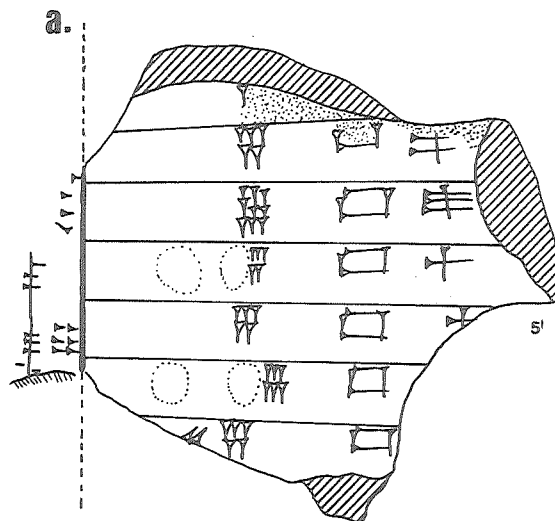

380.6 (MM 337)

380.6. Sello: figuración sin leyenda

AnOr 7 380.6
?
Š48/-/-

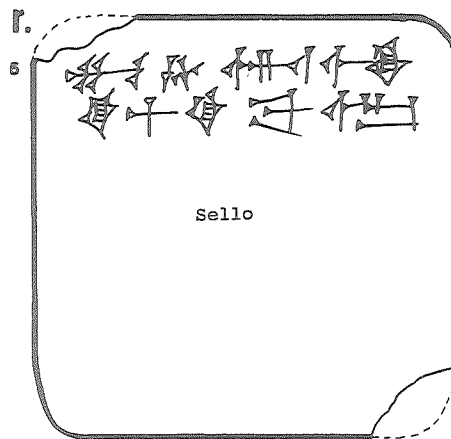
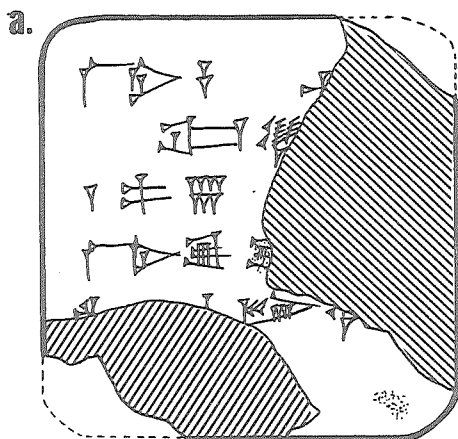

380.7 (MM 222)

380.7. Sello:

AnOr 7 380.7
Umma
AS8/-/-

Ur-³Nun-gal
dub-sar
dumu Ur-⁴Šara₂
ša₁₃-dub-ba

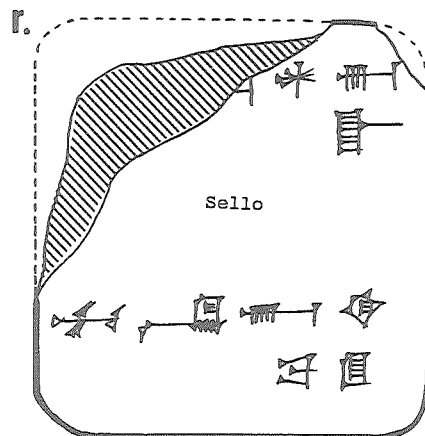
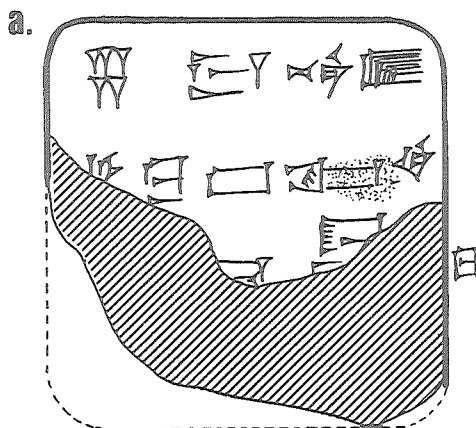

380.8 (MM 226)

380.8. Sello:

AnOr 7 380.8
Umma o Lagaš
-vi/-

Ur-³Ba-ba₆
dumu Na-di₁₁

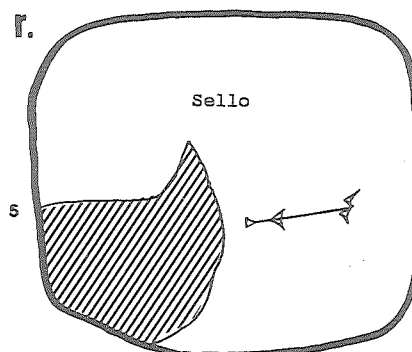
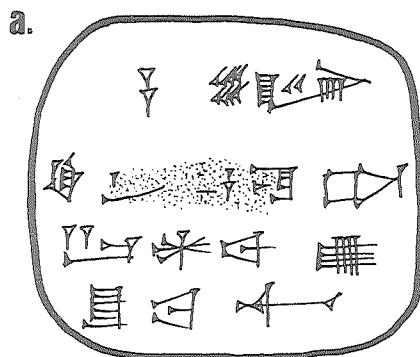

380.9 (MM 360)

AnOr 7 380.9
Umma
[]

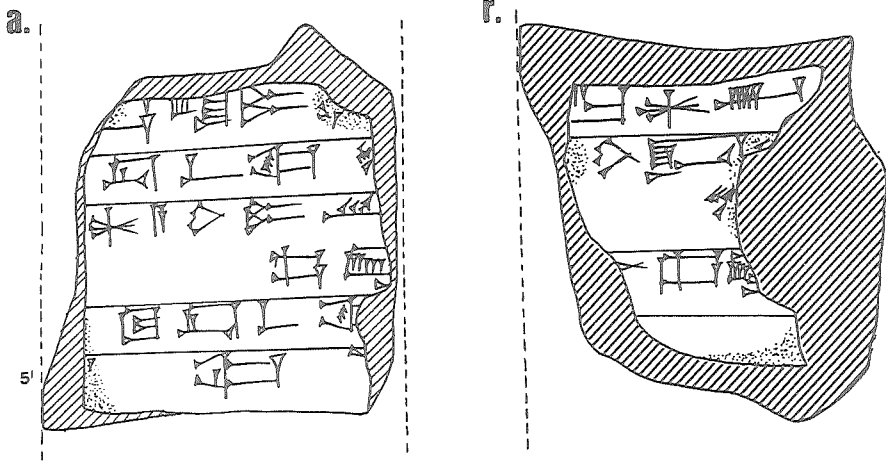

383 (MM 63b)

Drehem
Š33 ó 45/viii/8²

Anverso destruido

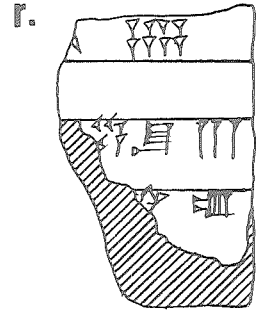

380.10 (MM 348)

AnOr 7 380.10
Umma
[]

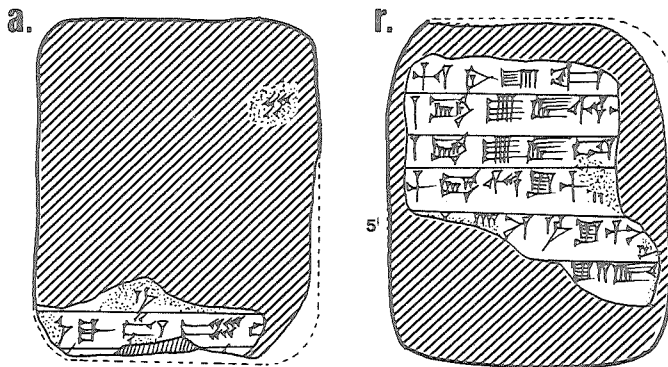

384 (MM 173)

Umma
ŠS4/-

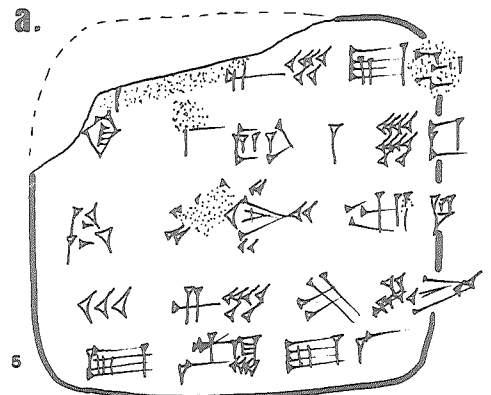

381 (MM 490)

AnOr 7 381

Tablilla actualmente demasiado destruida para copia
Reverso anepigráfico atravesado longitudinalmente por una raya de tachadura

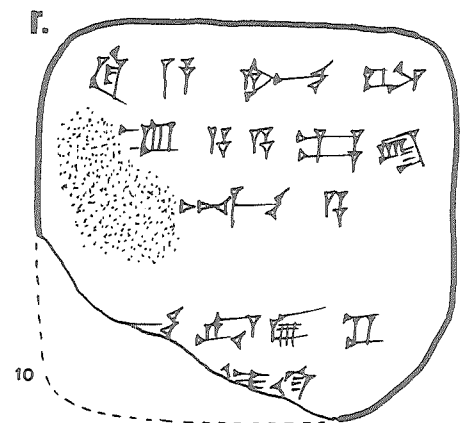

382 (MM 63)

Drehem
Š44/[]

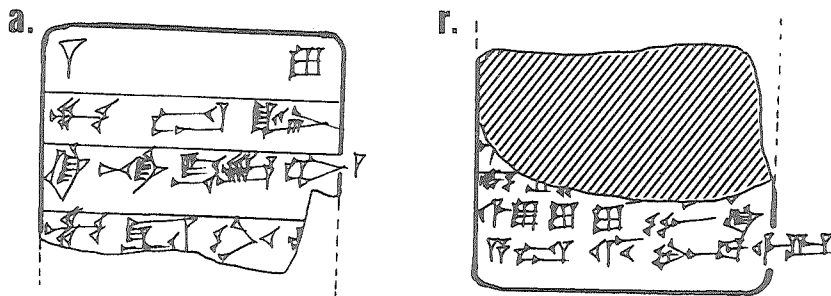

384. Sello:

ʾA-kal-[-la]
dub-[sar]
dumu Lu₂-š[a₂-ga]

385 (MM 175)

Drehem
 ŠS7/vii/[x+]3

385. Sello:

- i [dŠu]-dSuen
 [lugal] kal-ga
 lugal Uri₂^{ki}-ma
 [lugal] dUb-/da limmu₂-ba
- ii [Nanna-ma-ba]
 ʾdub ʾ-[sar]
 dumu U₂-[na]-ap-/ʾše ʾ-e[n]
 arad₂-[zu]

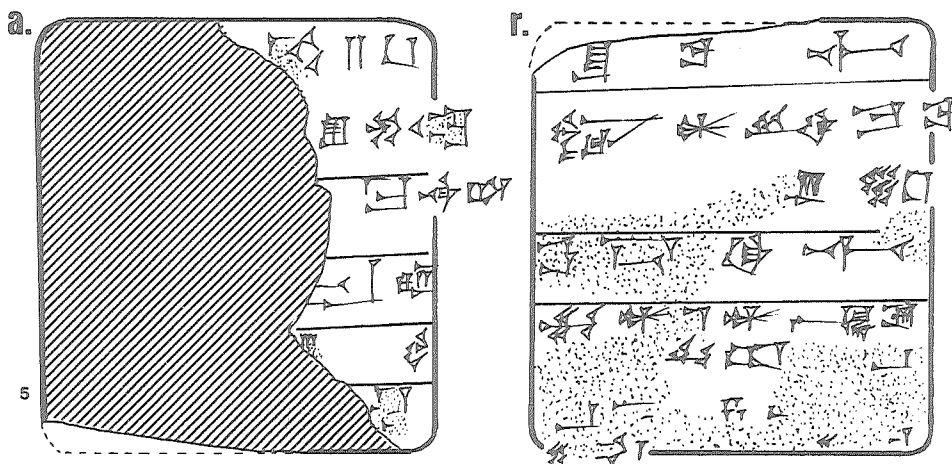

386 (MM 210)

?
 []

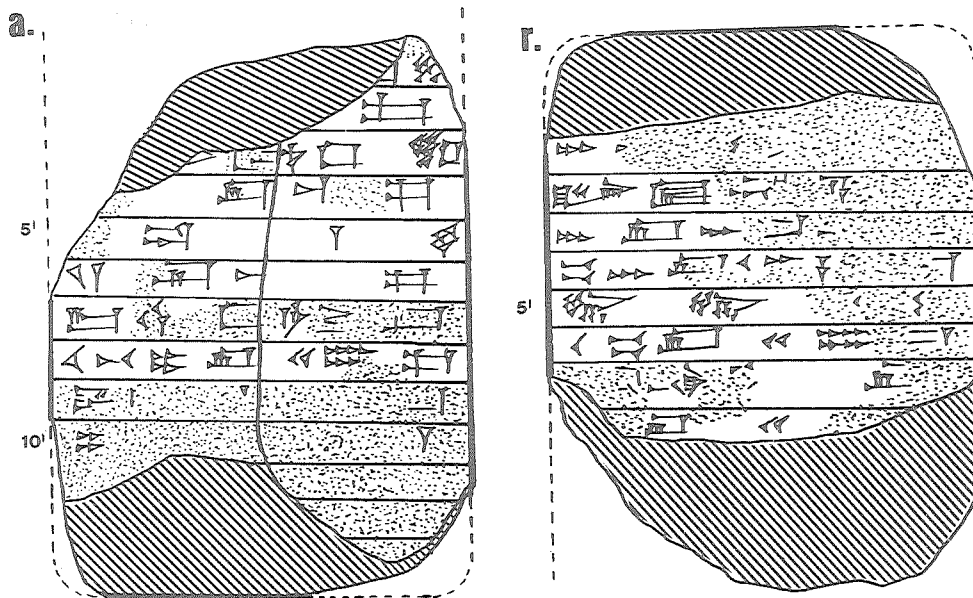

387 (MM 227)

Umma
 -/-

387. Sello:

Ur-ni₉-gar
 ʾdub-sar ʾ
 dumu Lu₂-[(du₁₀)²]-ga

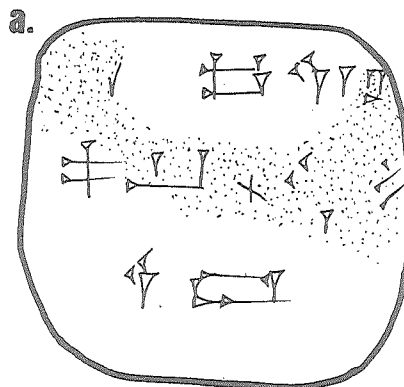

388 (MM 231)

Lagaš
[]

Medidas originales aprox. 200 x 200 y seis columnas por cada cara

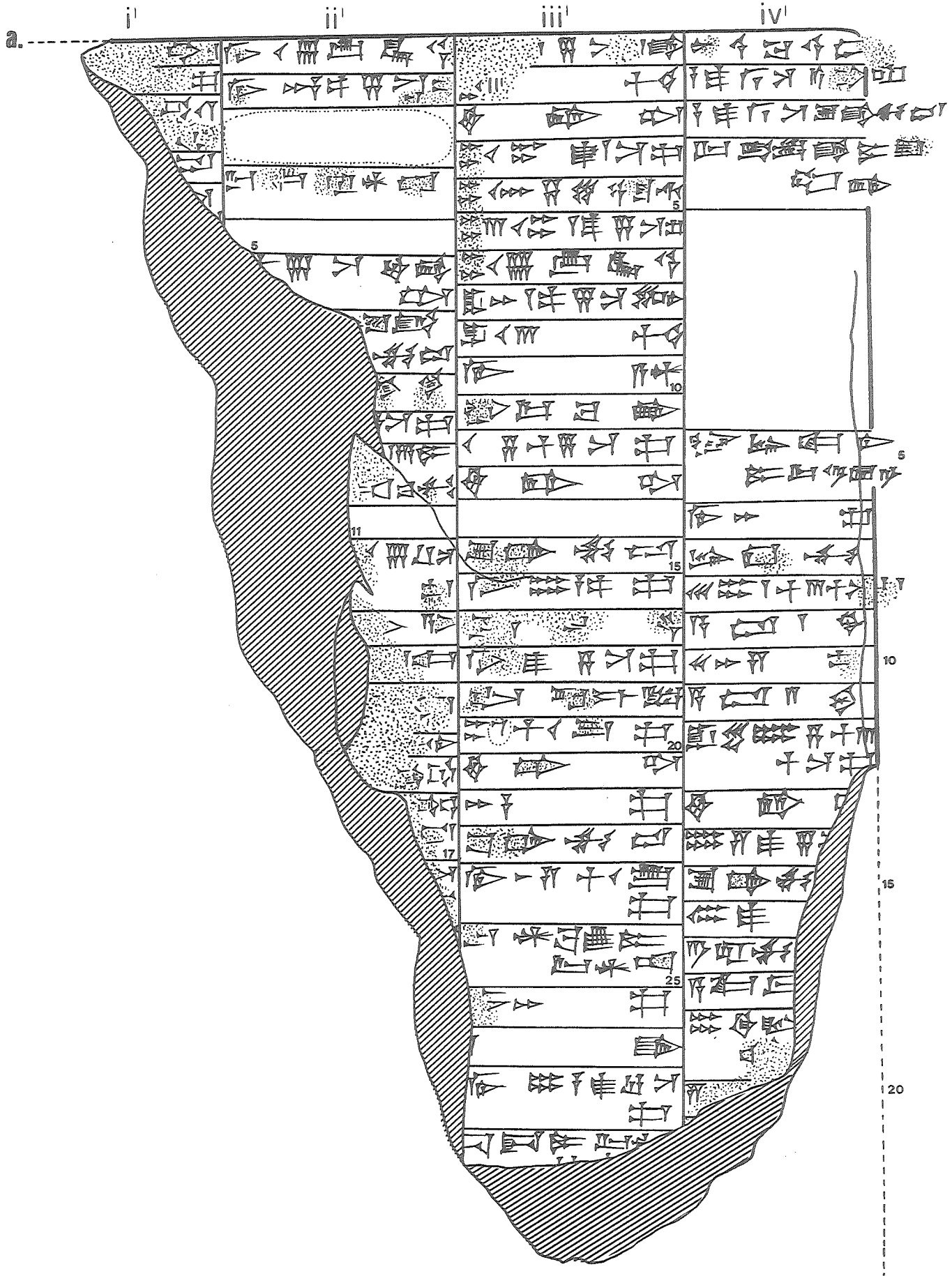

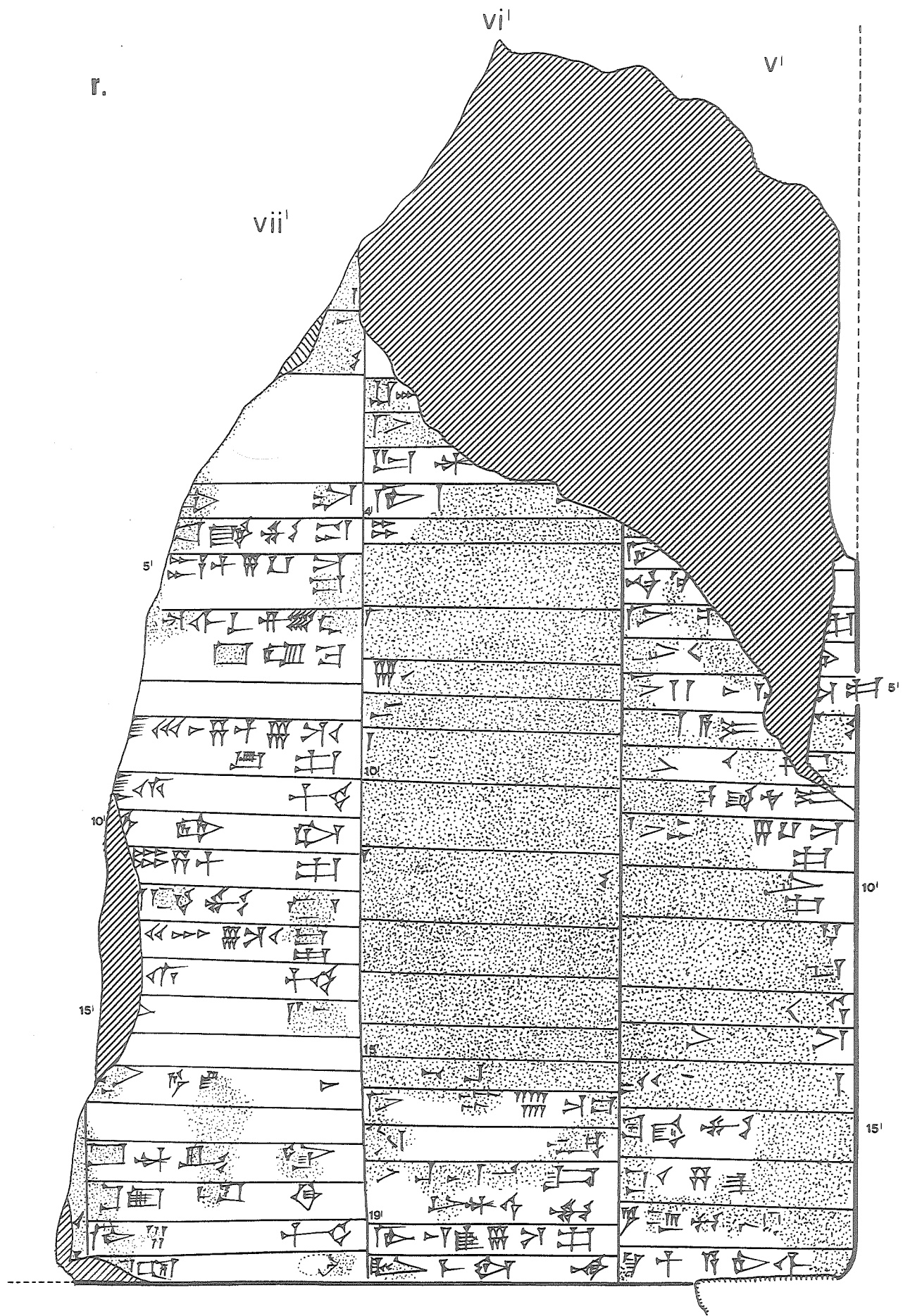

389 (MM 353)

Lagaš
[]

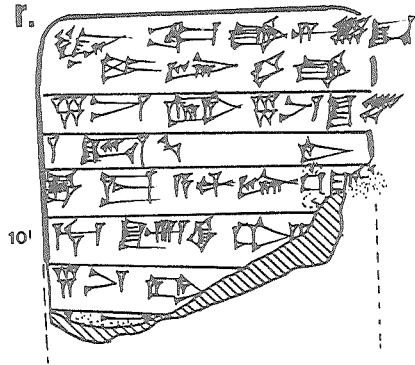
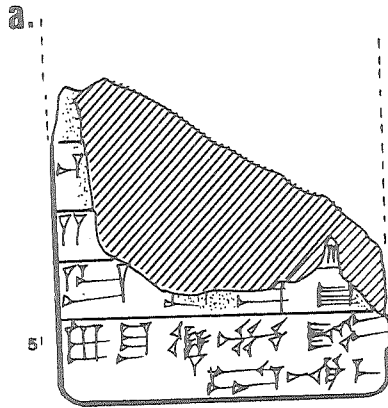

390 (MM 362)

Umma
šš7/[]

390. Sello:

Ur-e₂-maš
dub-sar
dumu Ur-TAR.SUKKAL

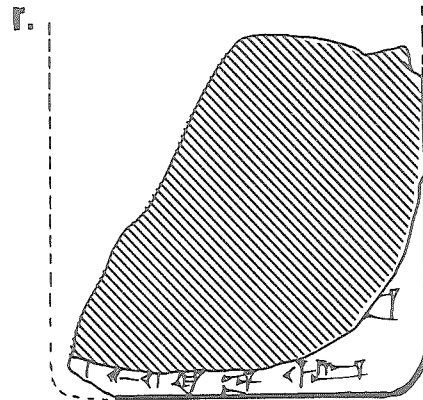
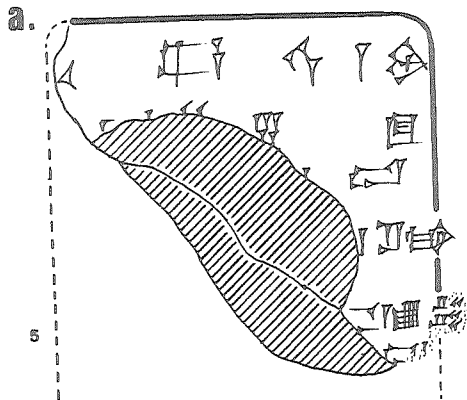

391 (MM 404)

Lagaš
-viii/-

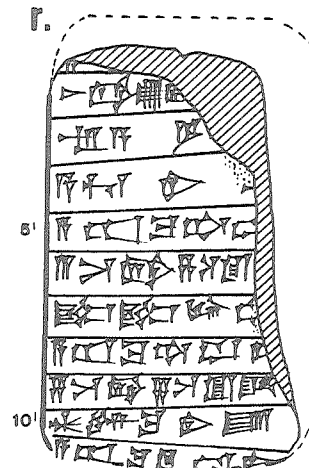
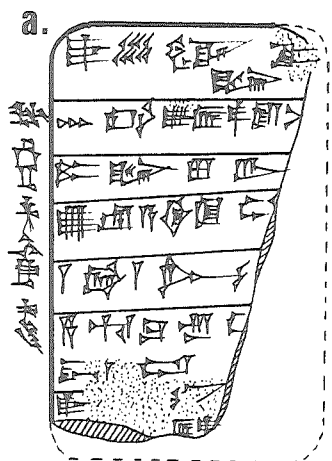

392 (MM 413)

Umma
[]

Anverso destruido

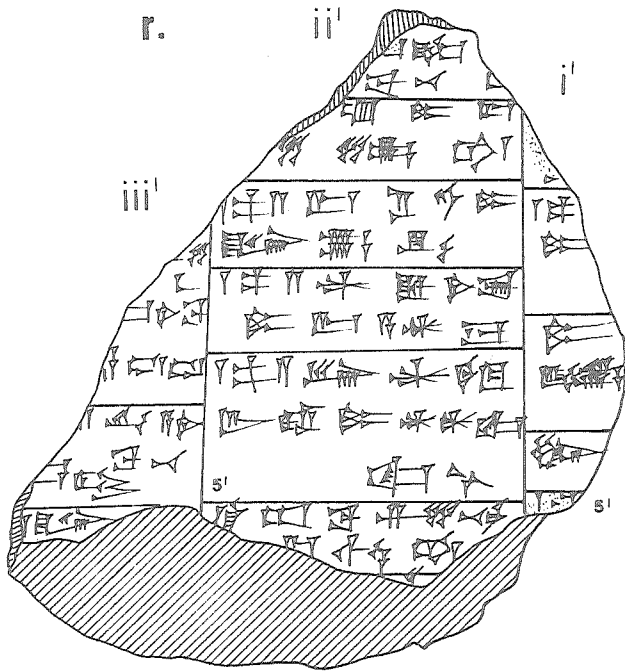

393 (MM 431)

Lagaš
-vi/10

Perdida aprox. media tablilla

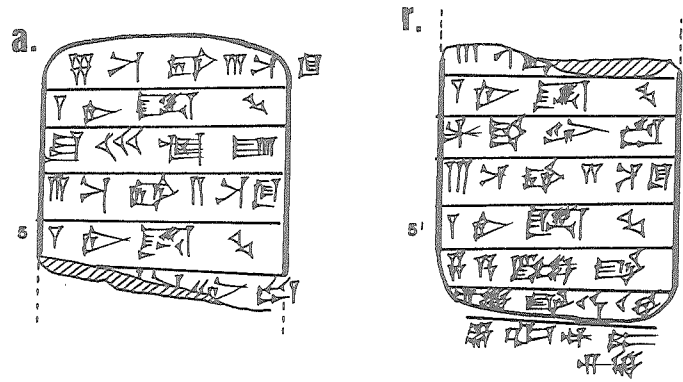

394 (MM 439)

Lagaš
-/-

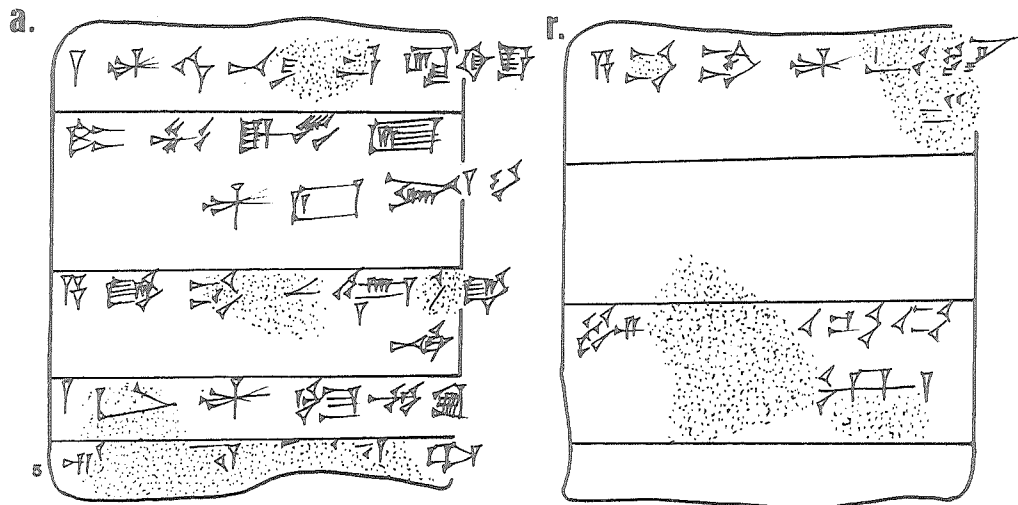

395 (MM 482)

Umma
Š34/x/-

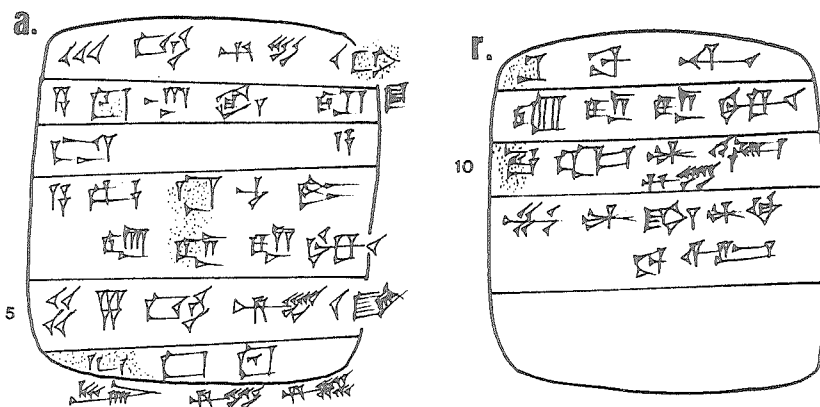

396 (MM 483)

Umma
ŠS3/-/

396. Sello:

Ur-⁴Nun-gal
dub-sar
dumu Ur-⁴Šara₂
ša₁₃-dub-ba-ka

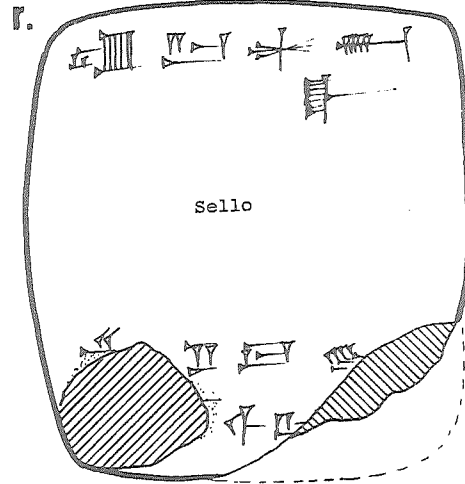
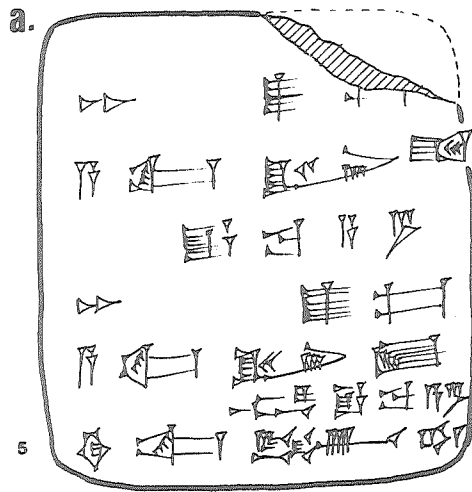

397 (MM 484)

Umma
ŠS2/-/

397. Sello:

Lu₂-gi-na
dub-sar
dumu Ša₃-ku₃-ge

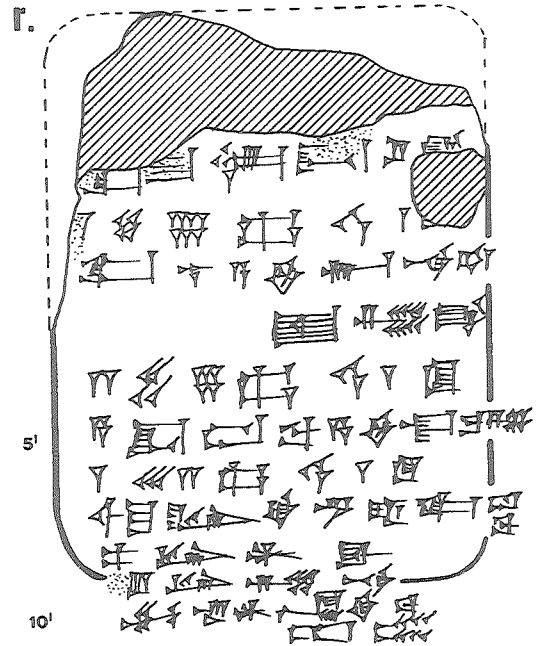
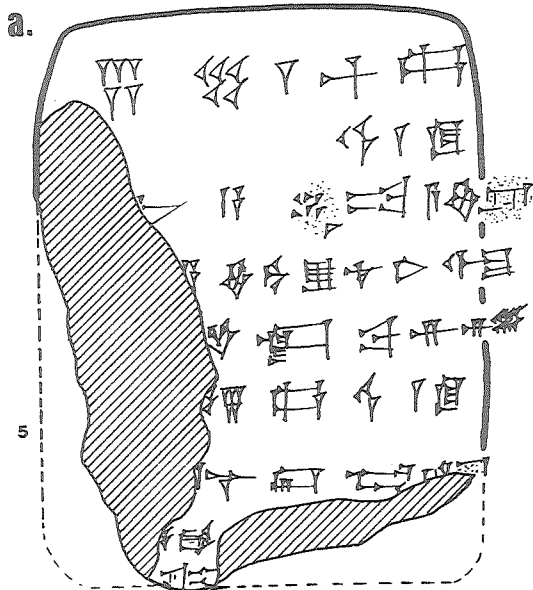

Umma
[]

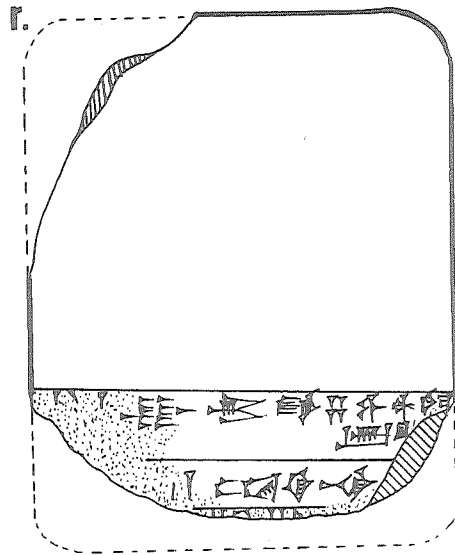
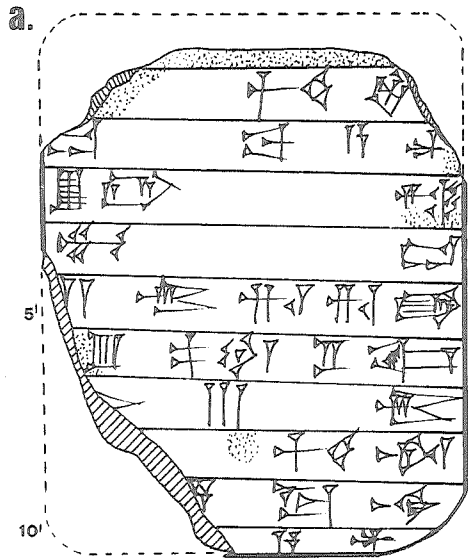

399 (MM 486)

399. Sello:

Umma
ŠS1/-/-

Gu-u₂-gu-a
dub-sar
dumu Ma-an-sum

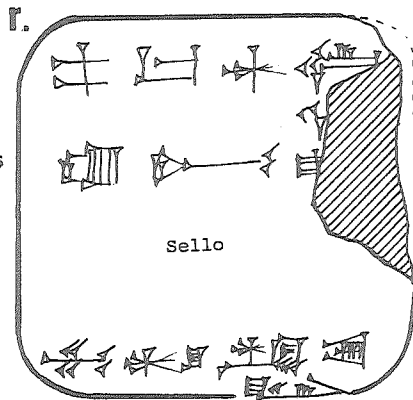
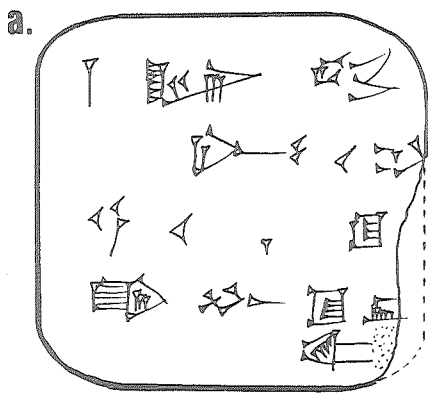

400 (MM 487a)

400. Sello:

Umma
Š44/viii/-

Ur-⁴Nisaba]
dub-[sar]
dumu Ur-⁷ni,⁷-[gar]

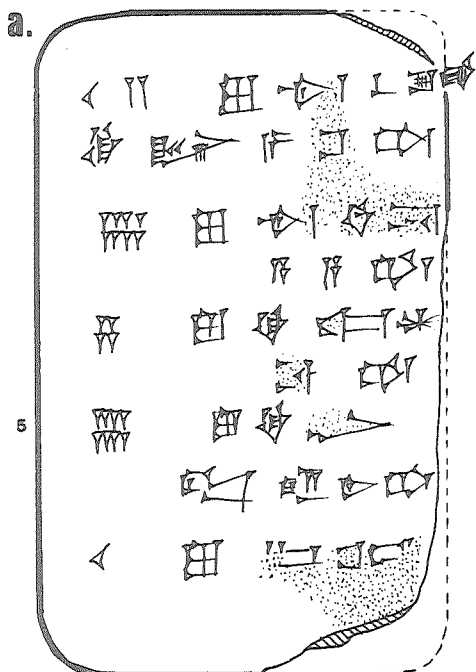

a.

r.

8

10

15

401 (MM 489)

Umma
ŠS2/v/-

401. Sello:

Inim-^dŠara,
dub-sar
dumu Lugal-^{iti}-d[a]

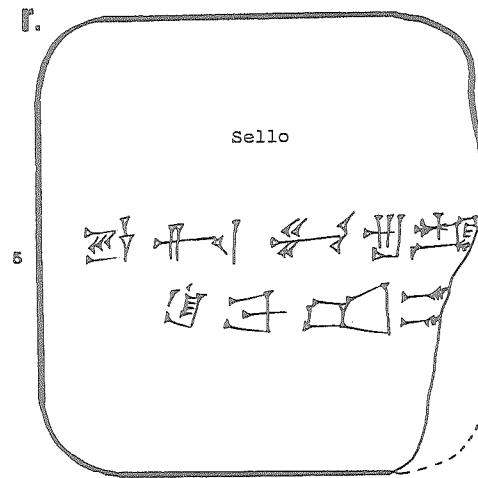
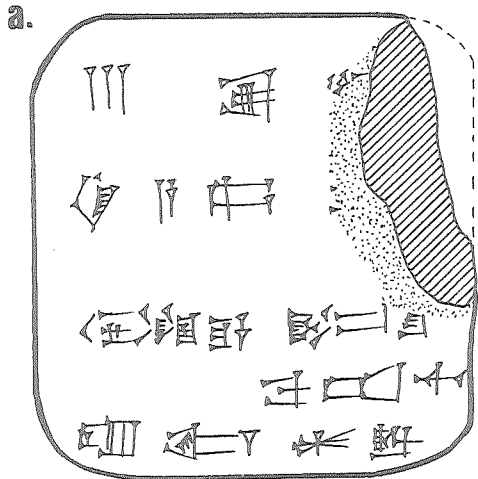

404 (MM 532)

Umma
[]

404. Sello:

Lu₂-^dHa-ia,
dub-sar
dumu Ur-e₁₁-e kuš,

Quizás misma tablilla que n° 403 y/o n° 465

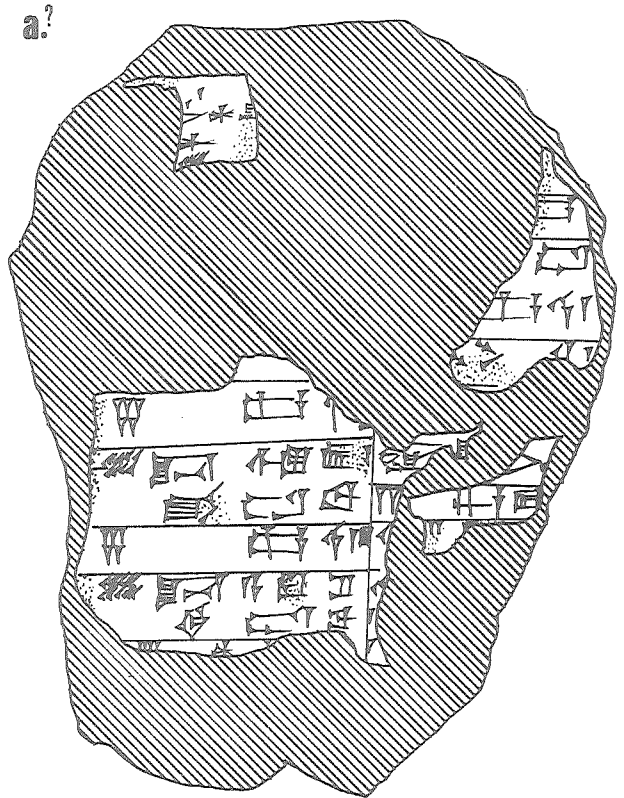

402 (MM 515)

Lagaš
-xii/-

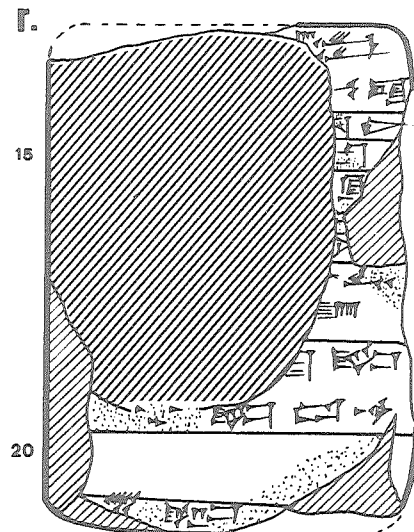
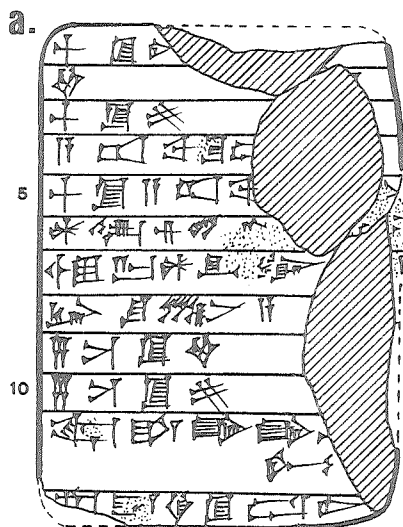

403 (MM 525+611b)

Umma
[]/vii 6 x/-

403. Sello:

Lu₂-^dHa-ia₃
dub-sar
dumu Ur-e₁₁-e kuš₇

Quizás misma tablilla que n° 404 y/o n° 465

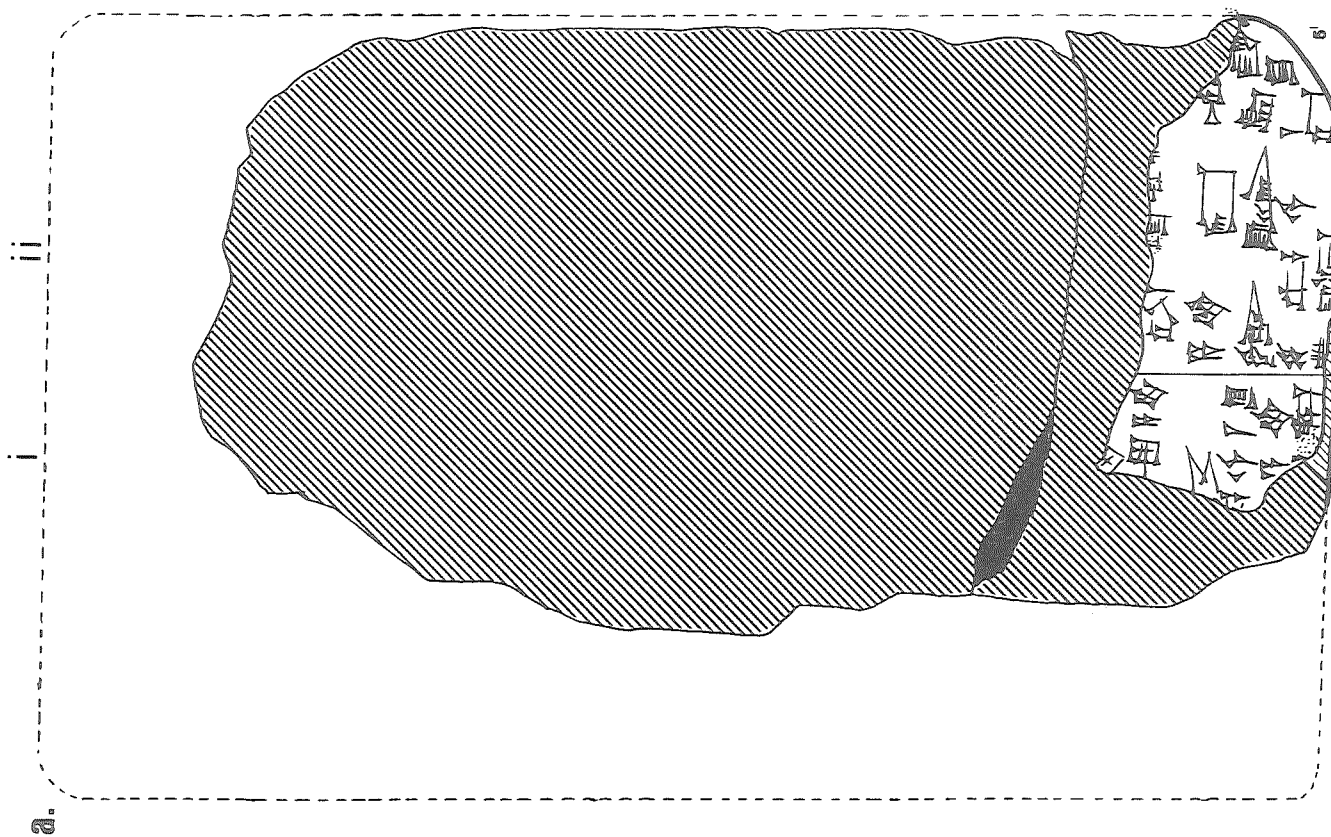
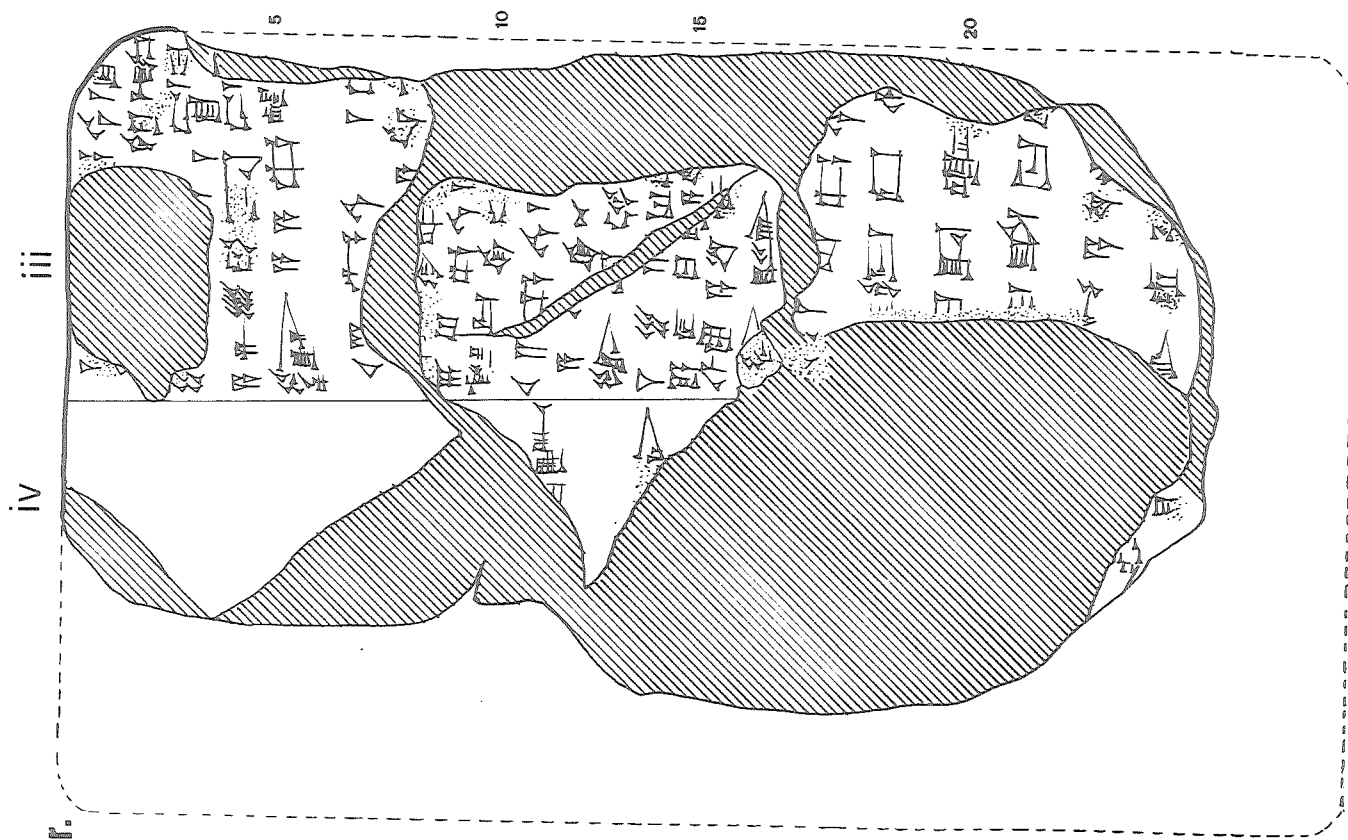

405 (MM 580)

Umma?
[]

Reverso destruido

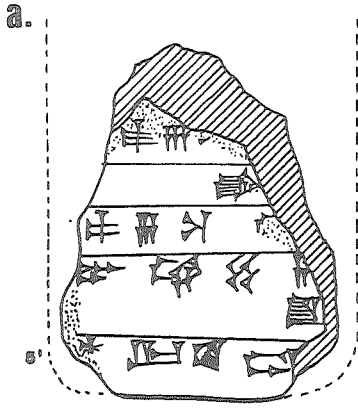

408 (MM 601)

?
Š39/vii 6 x/[?]

Anverso destruido

408. Sello ilegible

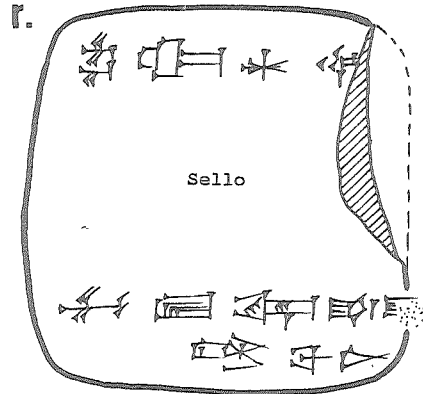

406 (MM 585)

Umma
Š44/vii/-

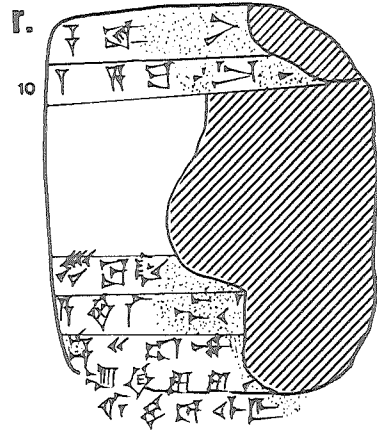
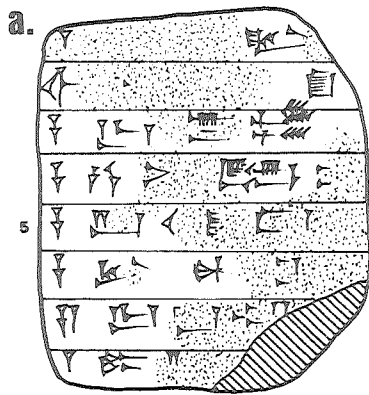

407 (MM 586+587)

Umma
ŠS4/-/-

407. Sello:

[^dŠara₂-kam]
[dub-sar]
[dumu Lugal]-ⁿⁱkir[₂]

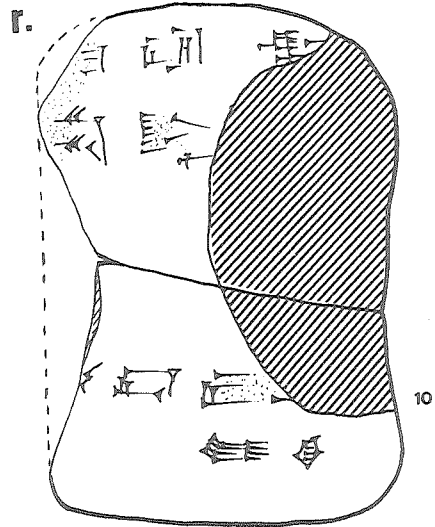
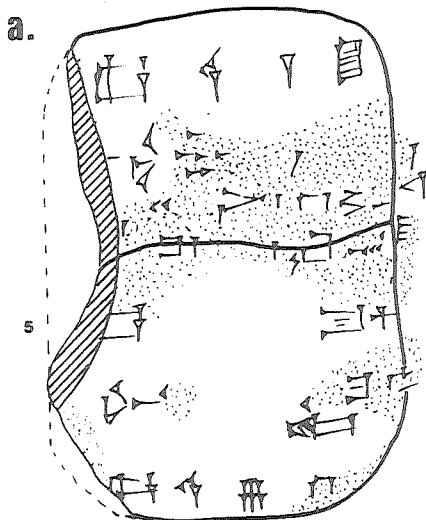

409 (MM 602b)

Umma
[]

Reverso anepigráfico

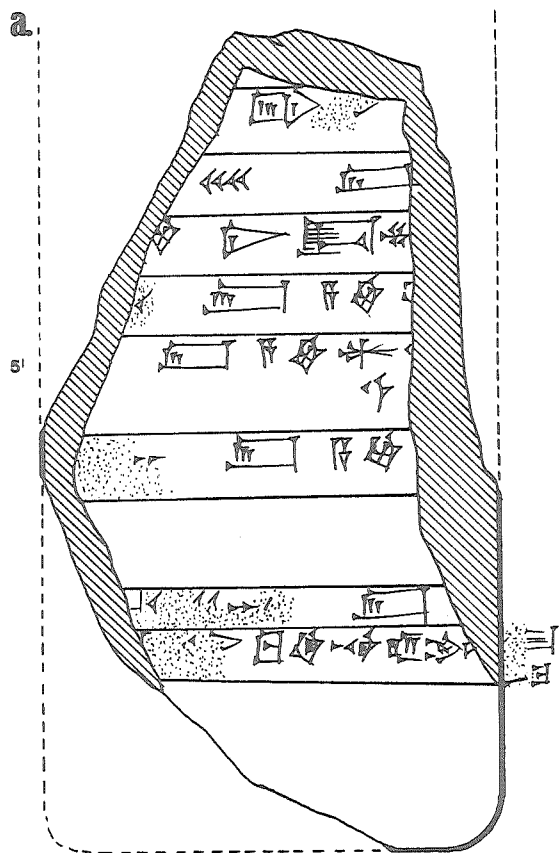

410 (MM 603)

Umma?
[]

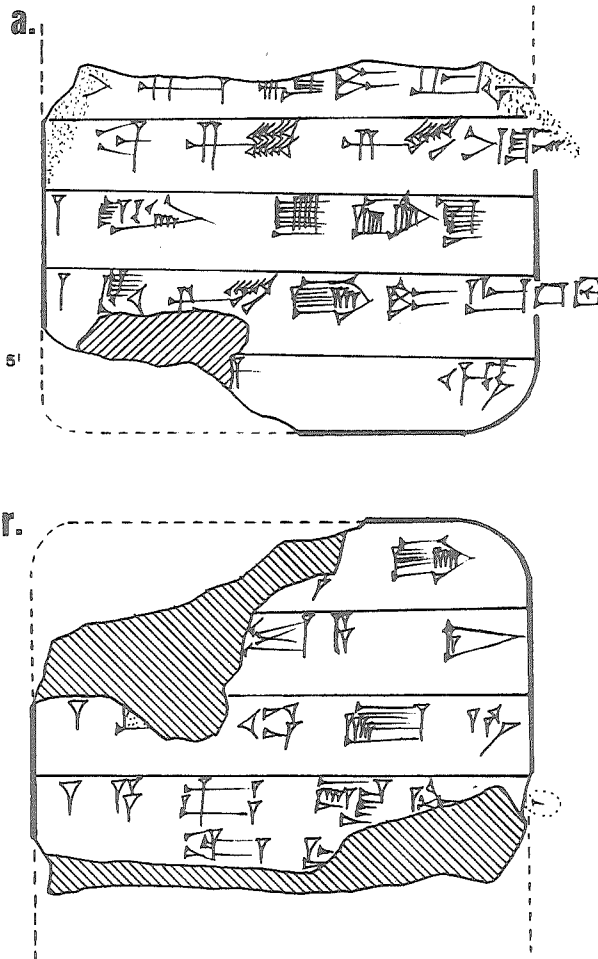

411 (MM 604)

Umma
Š46 ó AS3/viii/-

411. Sello:

[A]-kal-la
dub-sar
dumu [...]

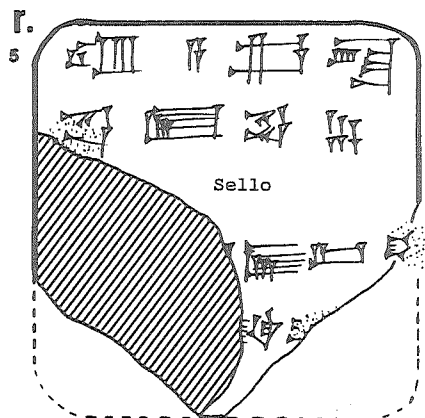
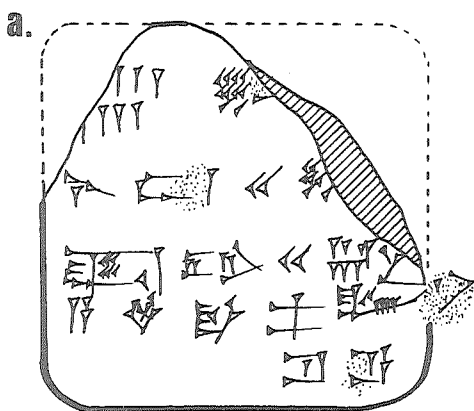

412 (MM 605b)

Umma
AS4 6 5/[]

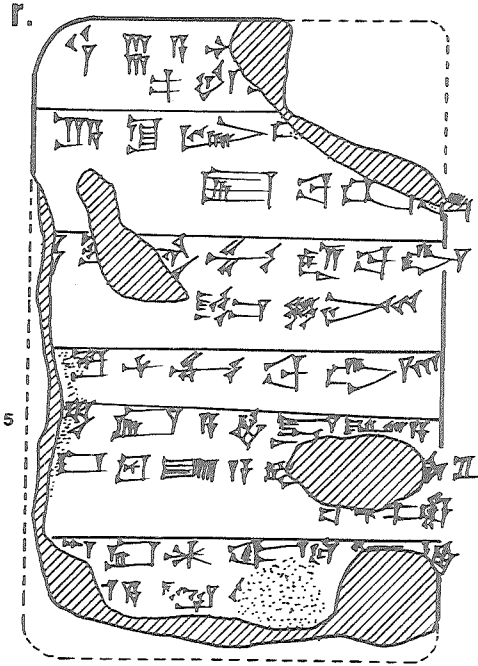
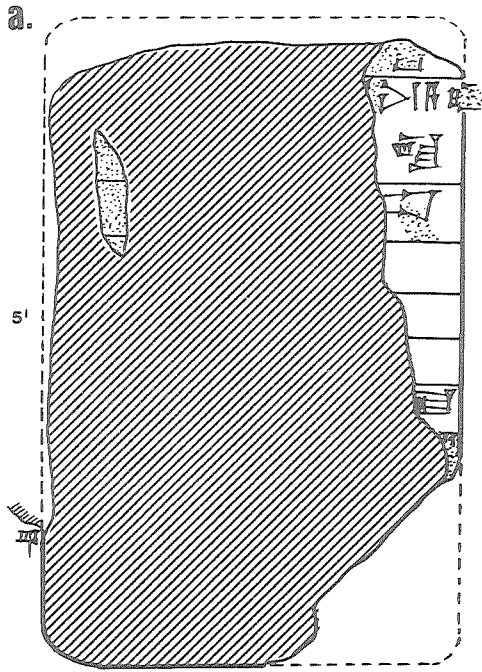

413 (MM 606)

Umma
[]

413. Sello ilegible

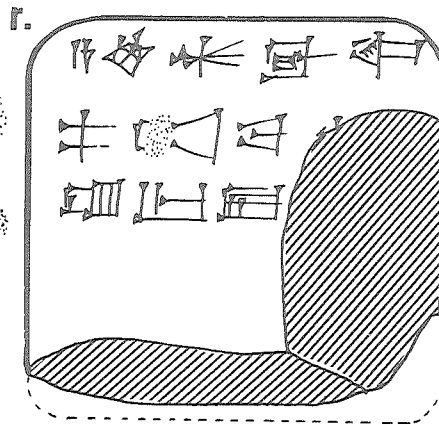
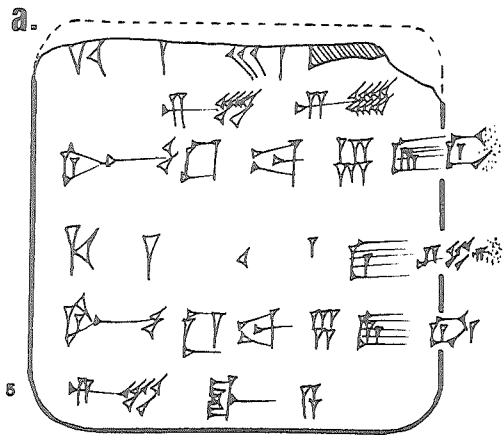

414 (MM 607)

414. Sello:

Umma
[]

Ur-am₃-ma²
dub-[sar]
dumu Na-[di]

Perdido aprox. 1/4 de la tablilla

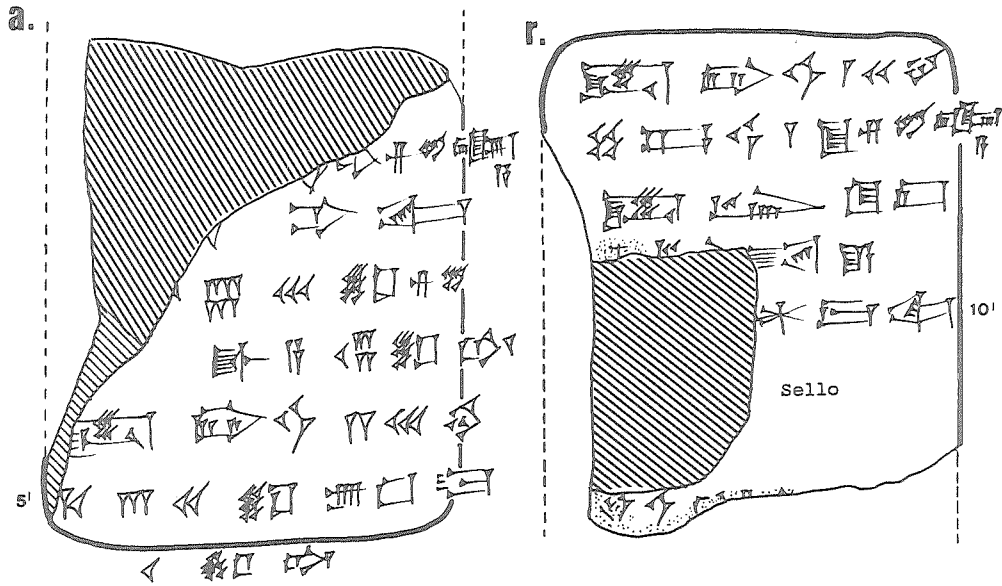

415 (MM 608 (+) 831)

Umma
[]

A. (MM 608)
Reverso destruido

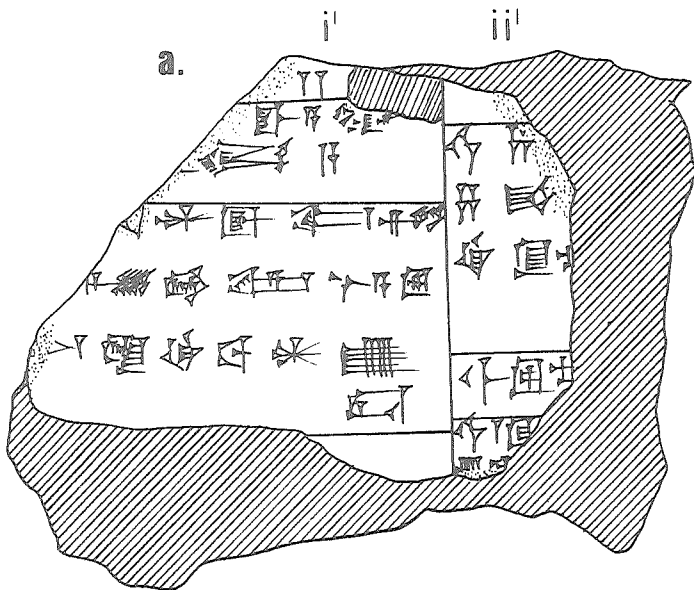

B. (MM 831)
Reverso destruido

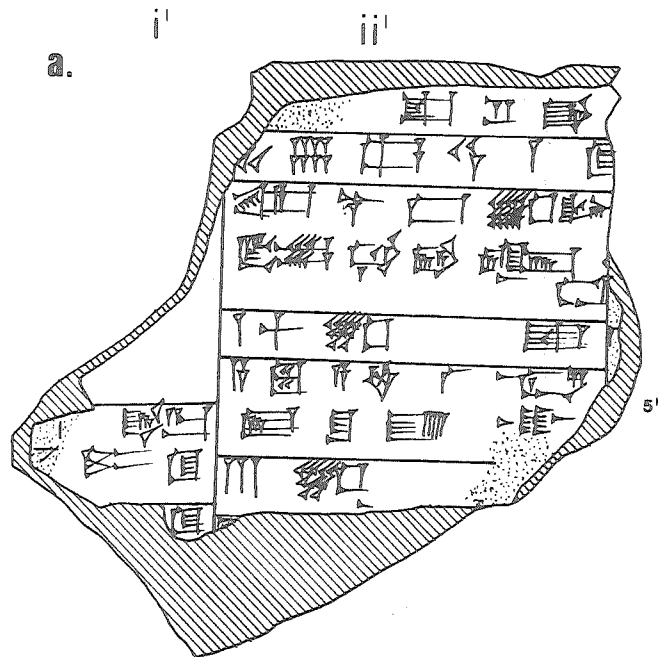

416 (MM 610)

?
[]

Perdido aprox. 1/4 de la tablilla
(serrada con fines comerciales)
Reverso anepigráfico

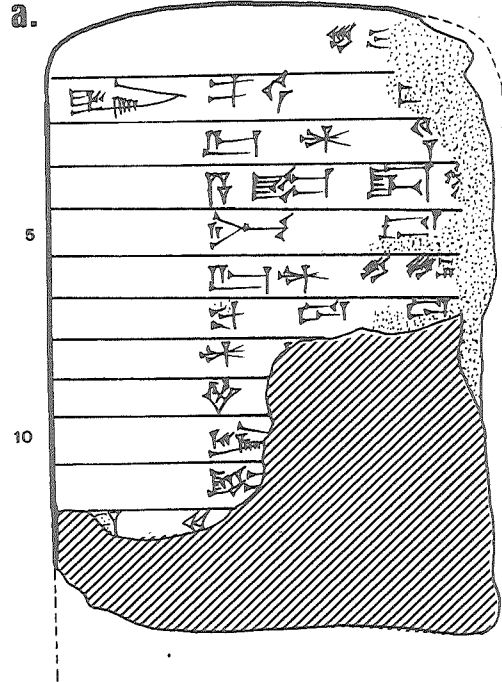

417 (MM 611)

Civil JCS 32 (1980) 169
Umma
Š34/-/-

417. Sello:

Ur-TAR.SUKKAL
dumu Ur-ŠE.E[Š₂']/.NIR.DA

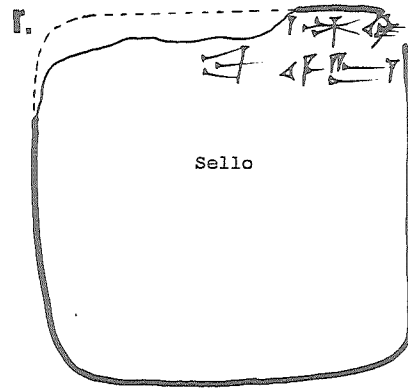
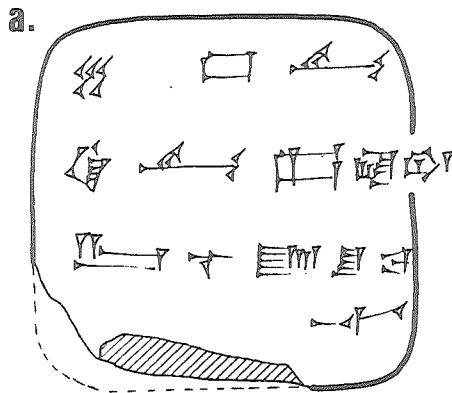

418 (MM 612)

Umma'
AS9/-/-

418. Sello:

Ur-En-li[l₂-la₂]
dub-sar
dumu Ur-En-k[i']

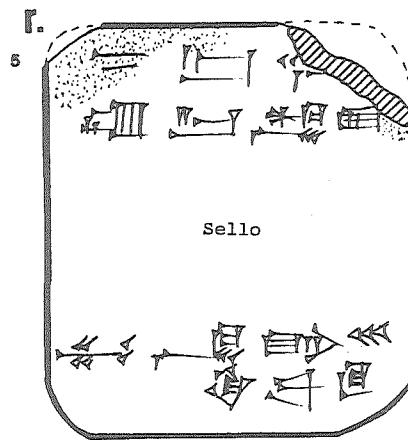
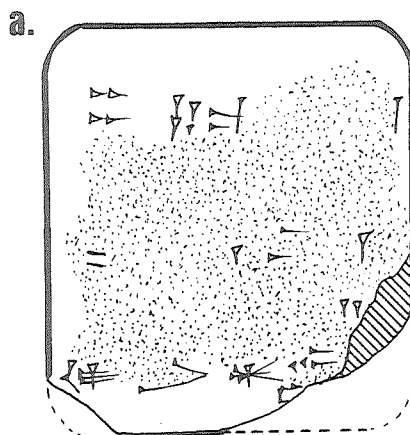

419 (MM 613)

Umma
ŠS9/-/-

419. Sello:

Ur₄-ša₃-ta-lu₂
dub-sar
dumu Ur-šu-ku₃-ga₃ "gudu₄"

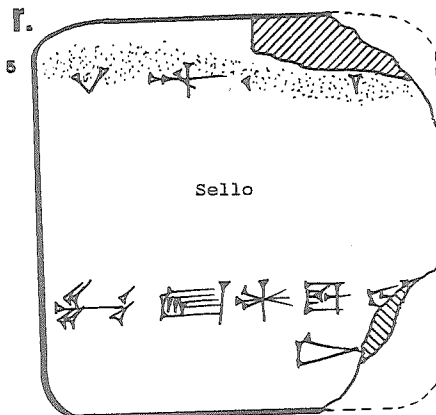
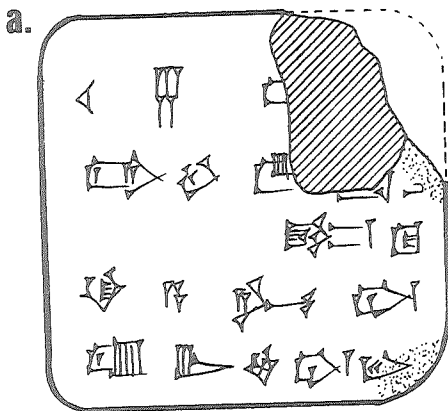

420 (MM 614)

Umma
ŠS7/-/-

420. Sello:

Šara₂-[kam]
dub-[sar]
dumu Lugal-ⁿⁱ[kiri₆]

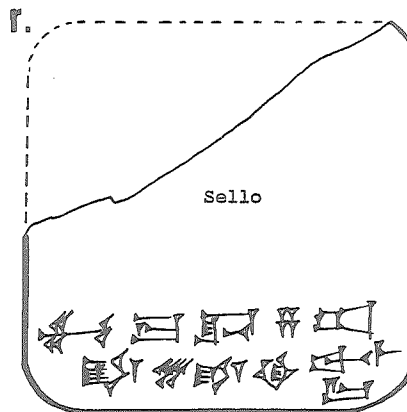
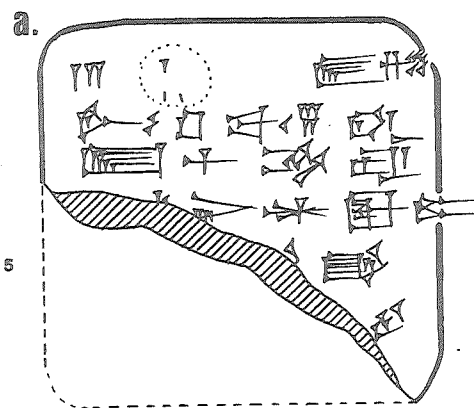

421 (MM 615)

Umma
ŠS.../-/-

421. Sello:

Lugal-nir
dub-sar
dumu [Ur-Šara₂]
"ša₁₃-dub-ba-ka"

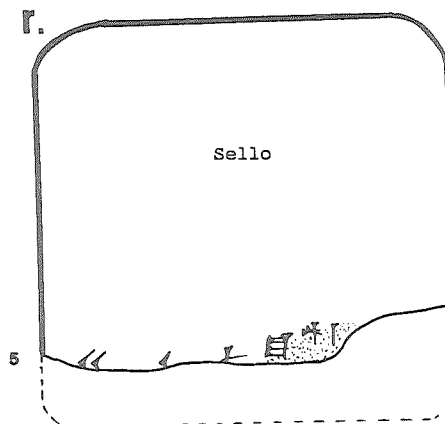
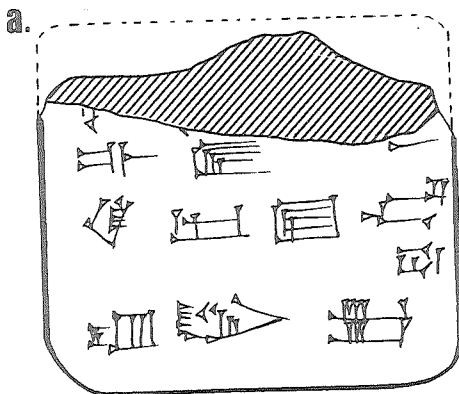

422 (MM 616)

Umma⁷
ŠS4/i/-

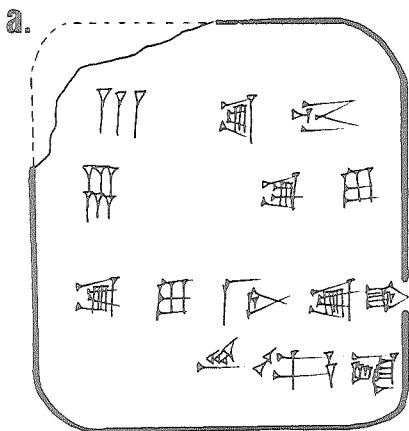

422. Sello:

Ur-d^r-Suen^r
dub-[sar]
dumu Lu₂-[...]

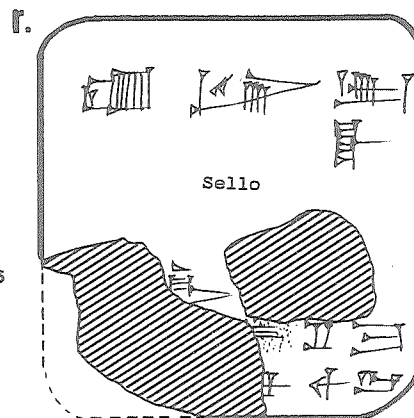

423 (MM 617)

Umma
ŠS3/-/-

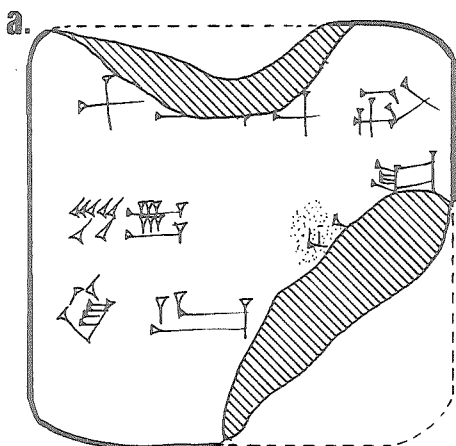

423. Sello:

Ur-ša₆-ga
dub-[sar]
dumu Lu₂-^{d^r}-[...]

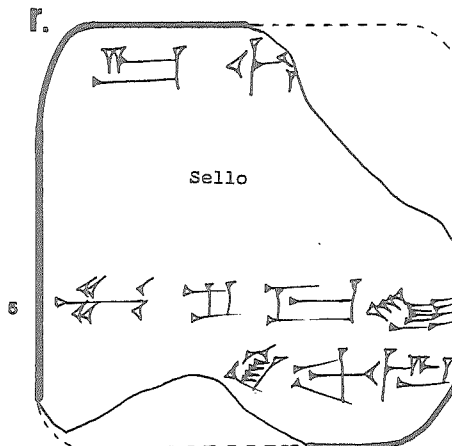

424 (MM 618)

Umma
AS2/[]/-

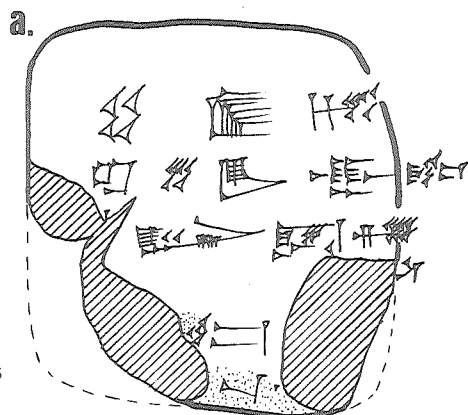

424. Sello:

Lu₂-kal-la
dub-sar
dumu Ur-e₁₁-[e kuš₇]

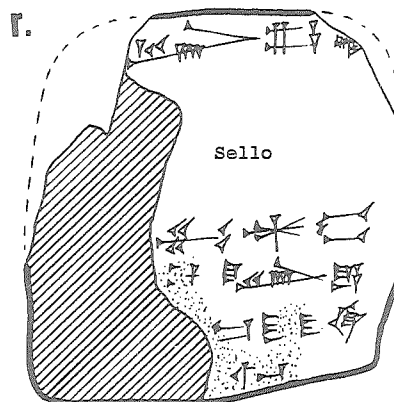

425 (MM 619)

Umma
Š43/-/-

425. Sello:

Ur-^o[Li₉-si₄]
en[si₂ Umma^{ki}]
A-tu^r dub-sar^r
[dumu Lu]gal-^rša₆-[ga]
[arad₂-zu]

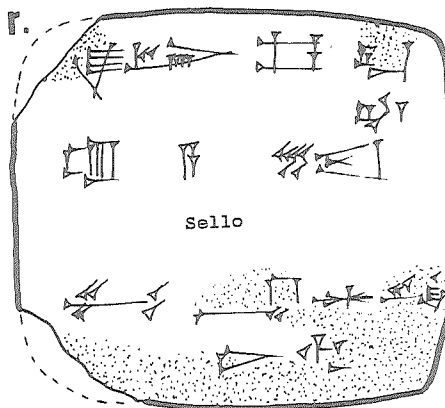
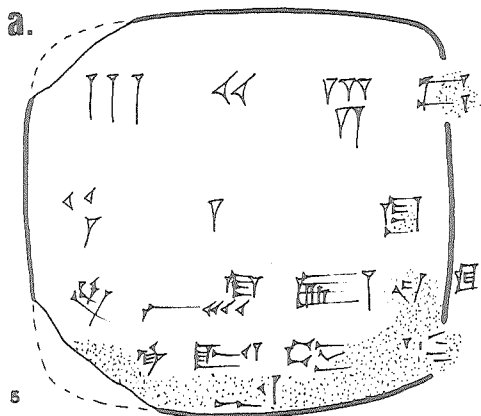

426 (MM 620)

Umma
ŠS8/-/-

426. Sello:

Lugal-nir
dub-[sar]
dumu [U]r-^o[Šara₂]
ša₁₃-[du]b-ba-[ka]

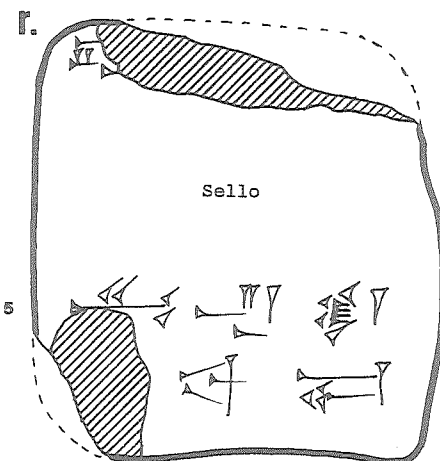
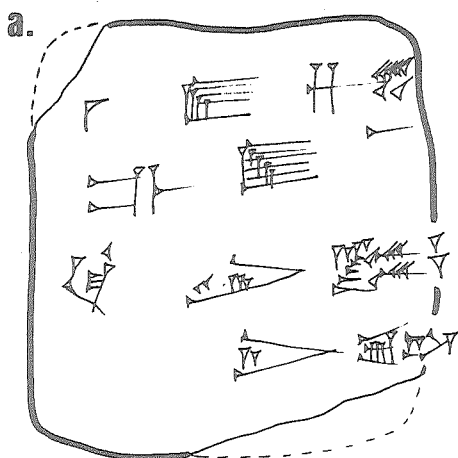

427 (MM 621)

Umma
AS8/-/-

427. Sello:

Lu₂-du₁₀-g[a]
dub-sar
dumu He₂-ma-^rDU^r

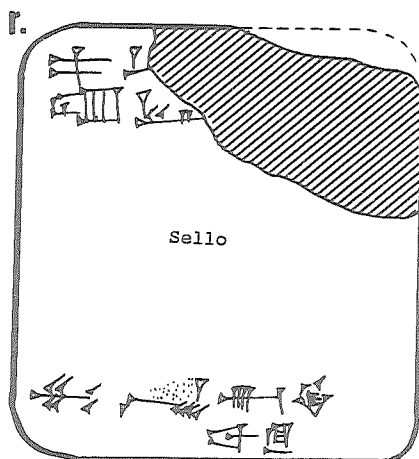
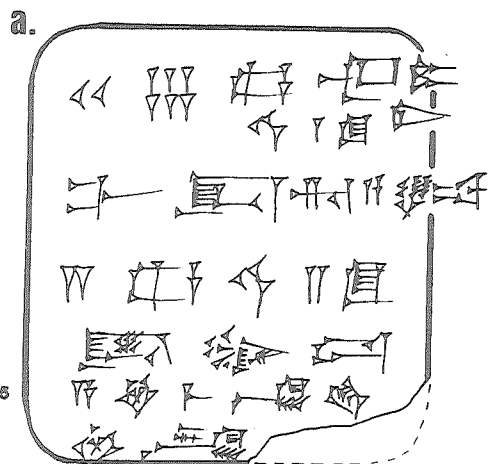

428 (MM 622)

Umma
Š44/-/-

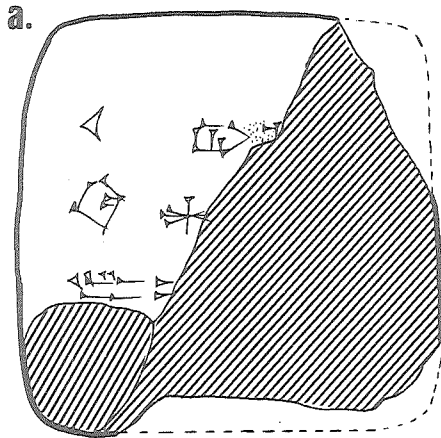

428. Sello:

[...]
dumu Lu₂[...]
gudu₂ Šara₂

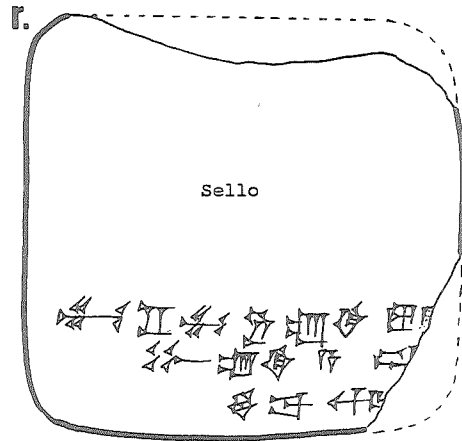

429 (MM 623)

Umma
Š33/vi/-

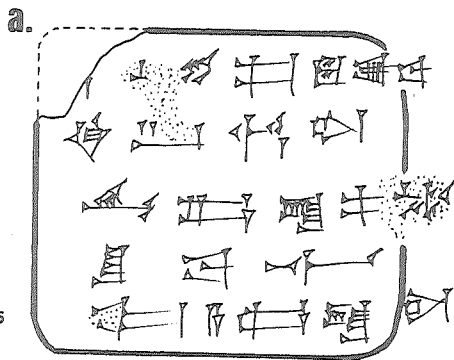

429. Sello:

Šeš-kal-la
[...]-da
arad₂ Ša₂ra

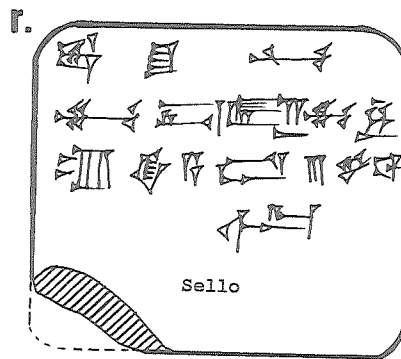

430 (MM 624)

Umma
Š38/ii/-

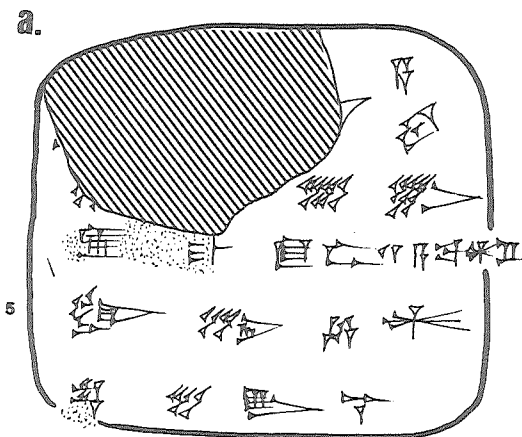

430. Sello:

i Ur⁴-Li₂-si₄
ensi₂ Umma^{ki}
Lu₂-kal-la
ii dub-sar
arad₂-zu

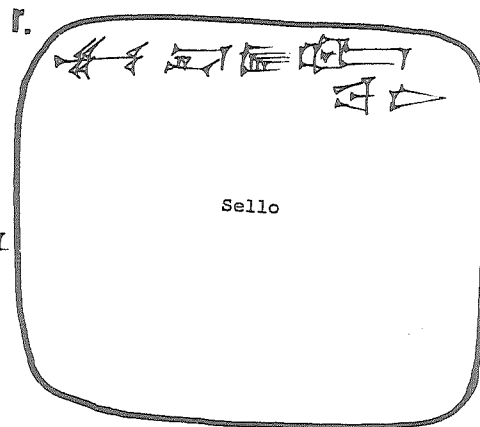

431 (MM 625)

Umma
Š45 6 AS2/xii/-

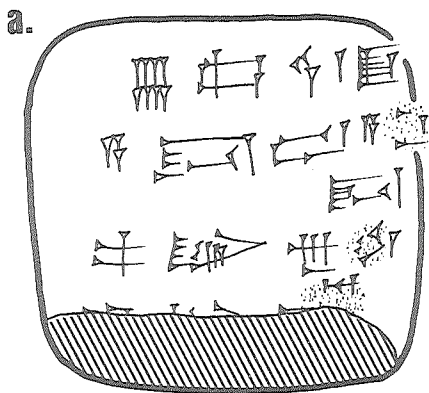

431. Sello:

Lugal-e₂-mah-e
dub-[sar]
dumu [Lu]g[al-ku₃]-ga-ni

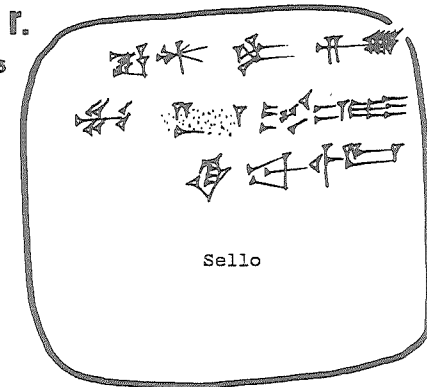

432 (MM 626)

Drehem
ŠS3/ix/-

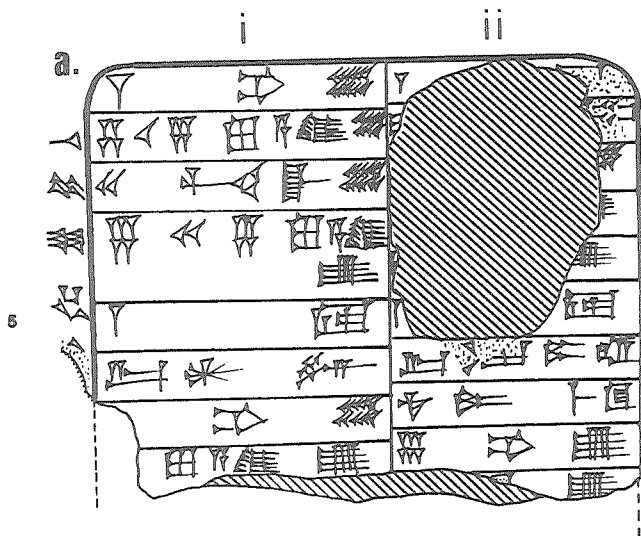

Perdido algo más de media tablilla



433 (MM 627)

Umma
AS9/-

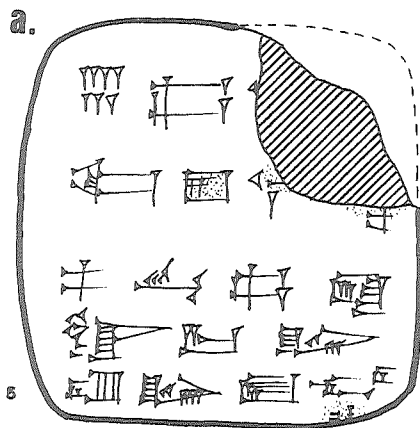

433. Sello:

Lugal-e₂-mah-e
dub-sar
dumu Lugal-ku₃-ga-ni

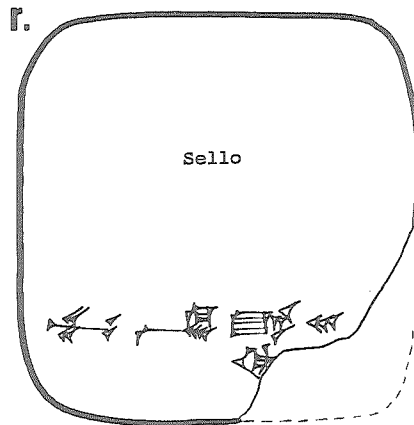

434 (MM 628)

Umma
AS9/-/-

434. Sello:

Ur-²Sama[n₃] (ŠE.EŠ₂.NU[N.BU])
dub-sar
dumu ʾLu₂-gi-na

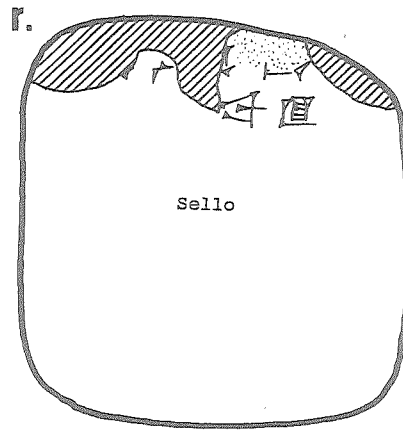
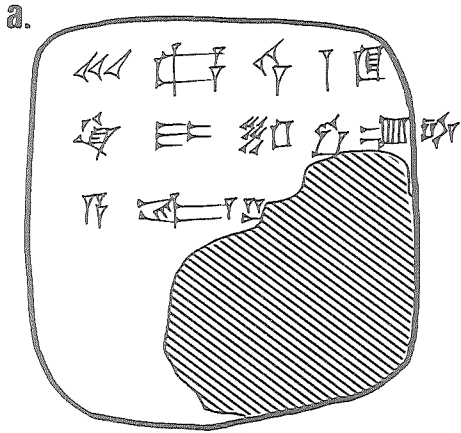

435 (MM 629+948)

Umma
[]

435. Sello:

Ur-TAR.[SUKKAL]
dumu Inim-²Sara₂
sa₁₂-du₃

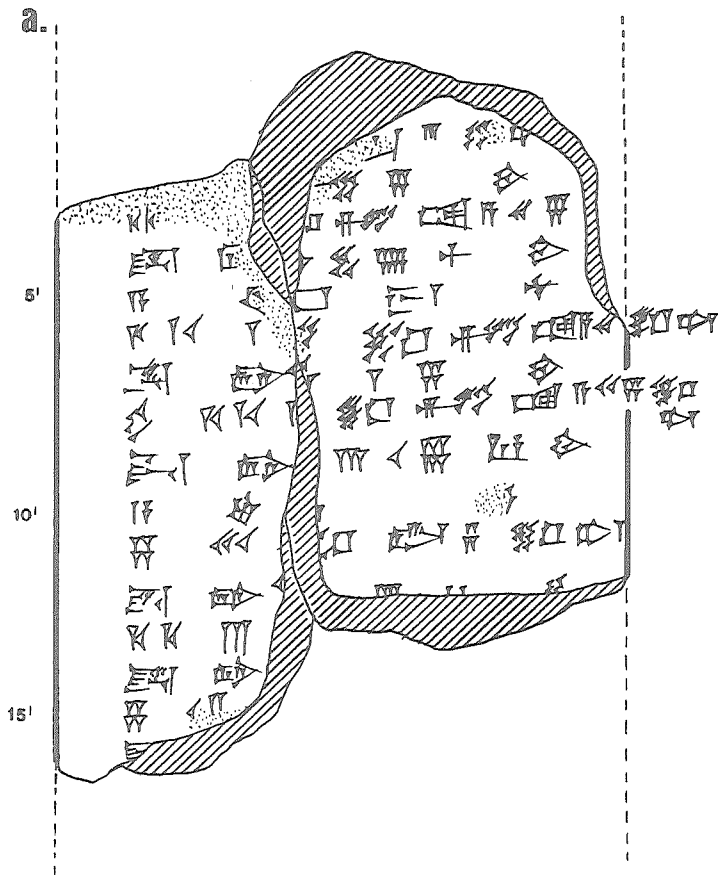

436 (MM 630+653)

Umma
ŠS.../!/-

436. Sello:

Lugal-si-NE-e
dub-sar
dumu Ur-e₂-nun-na

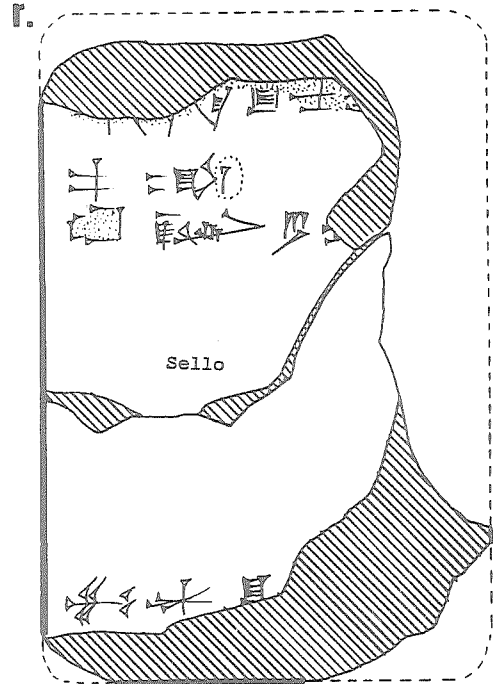
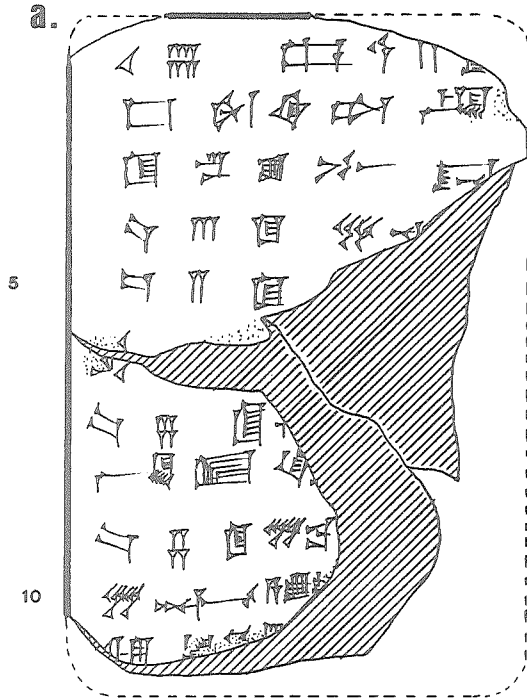

437 (MM 631)

Umima'
[]

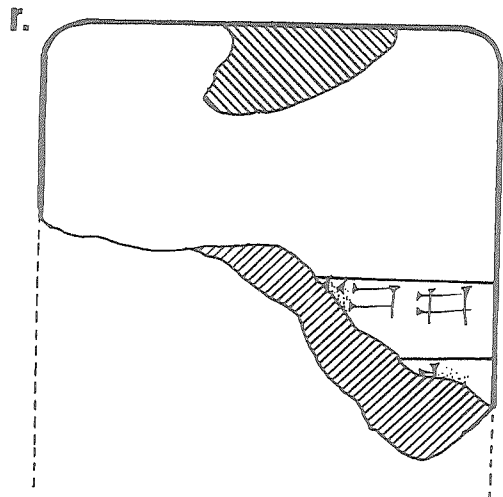
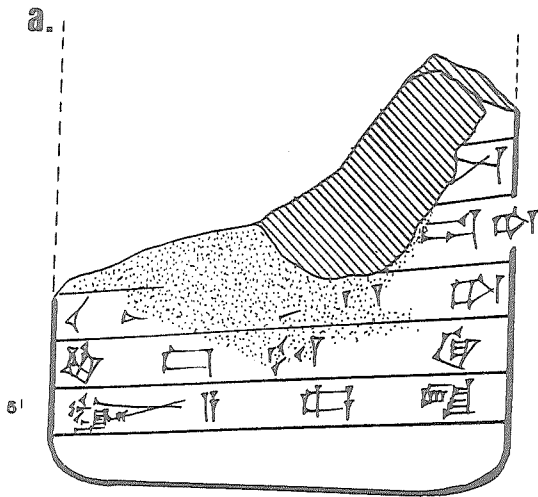

438 (MM 632)

Umma
Š47/x/-

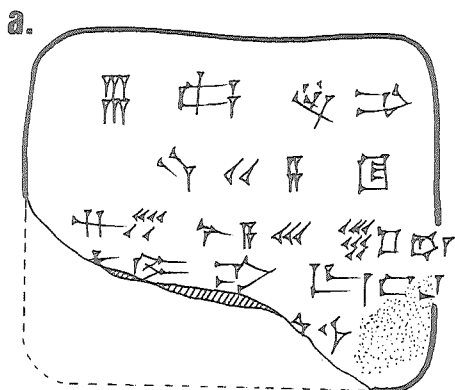

438. Sello:

Lugal-nesag₂-e
dub-sar
dumu Lu₂-ban₃-da

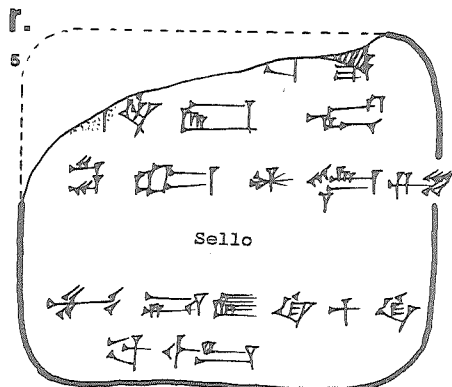

439 (MM 633)

Umma
[]/-

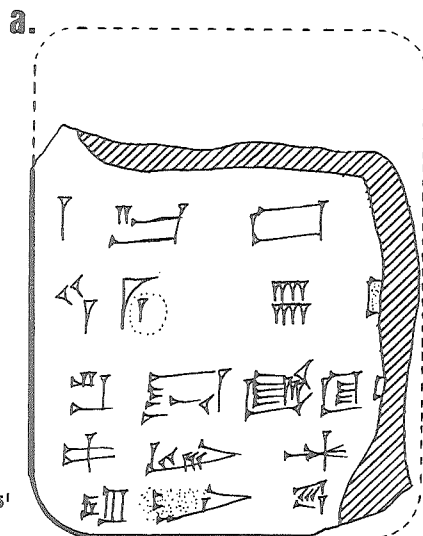

439. Sello:

Lugal-i[ū]-da
nu-banda₃ gu₄
dumu Giri₃-nē₂

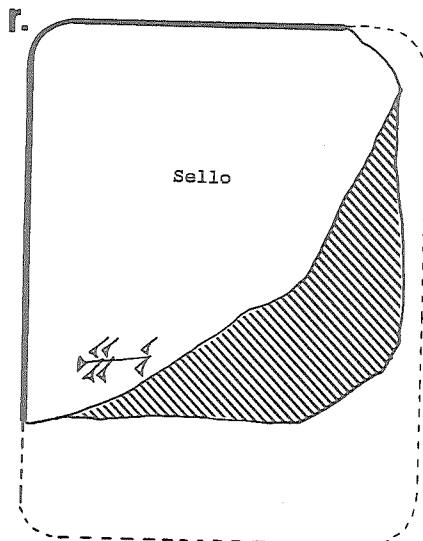

440 (MM 634)

Umma
IS3/- (i-iii)

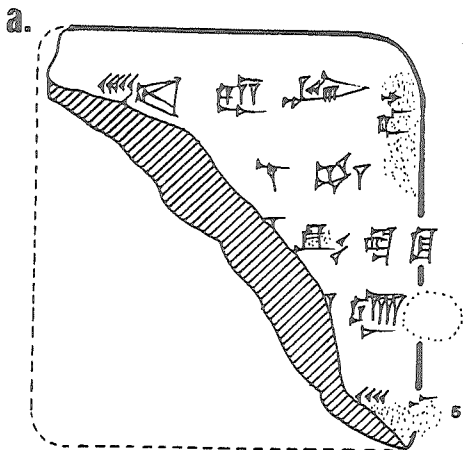

440. Sello:

- i Šu⁴-Suen
lugal-kal-ga
[lugal Ur]i₅-ma
lugal Ub-/[da limmu₂]-ba
- ii Lu₂-Šul-/[gi-ra⁷
[dub-sar]
[dumu Da-da-ga]
ar[ad₂-zu]

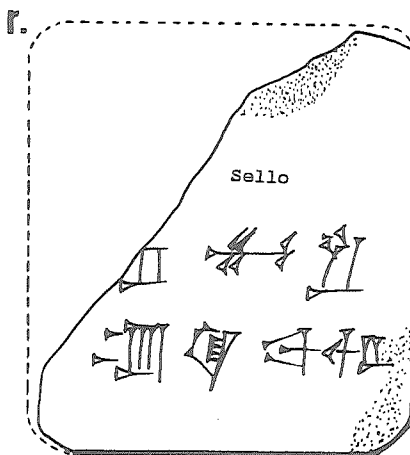

441 (MM 635)

Umma
AS3/v/1

441. Sello:

Da-a-^rgi^r
dub-sar
Línea en blanco

Perdido aprox. 1/3 de la tablilla

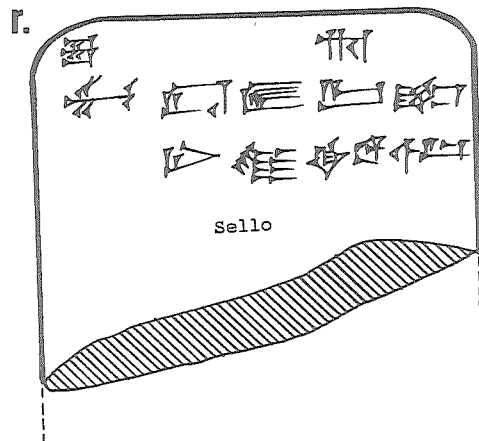
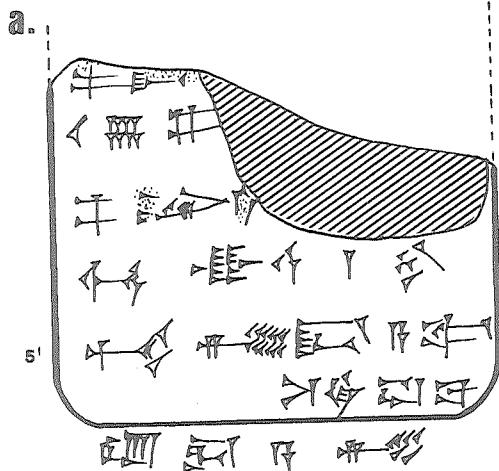

442 (MM 636)

Umma
ŠS1/-/

442. Sello:

[Šeš-kal-la]
^rdub^r-[sar]
dumu A.KA.[DUL]

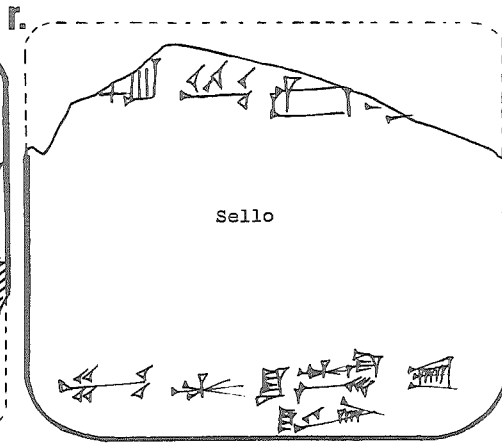
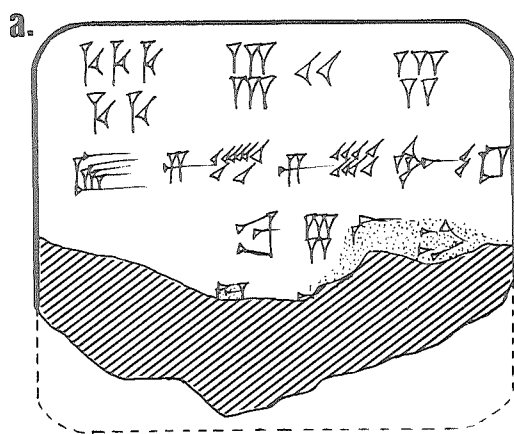

443 (MM 637)

Umma
[]

Perdida aprox. media tablilla

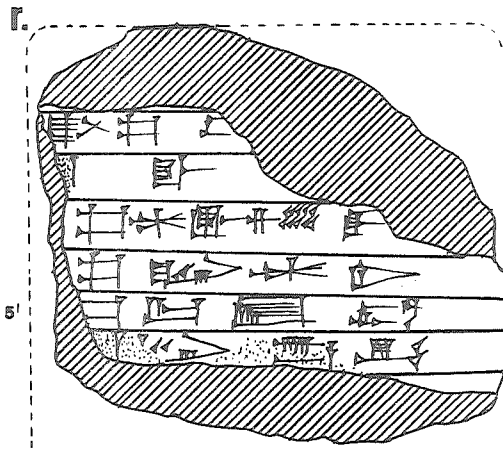
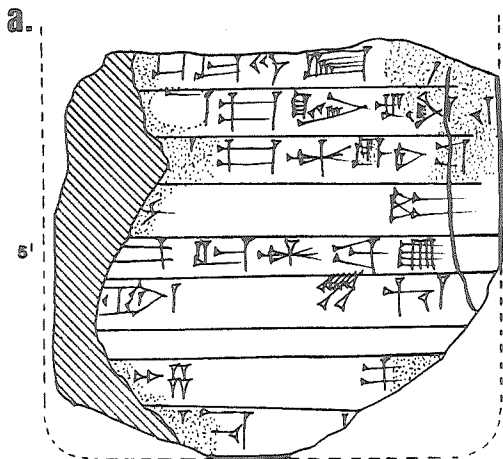

444 (MM 638)

Umma
ŠS1/ix/-

444. Sello:

Ur-²En⁻-[il₂-la₂]
dub-[sar]
dumu Lugal-ku₃-ga-[ni]

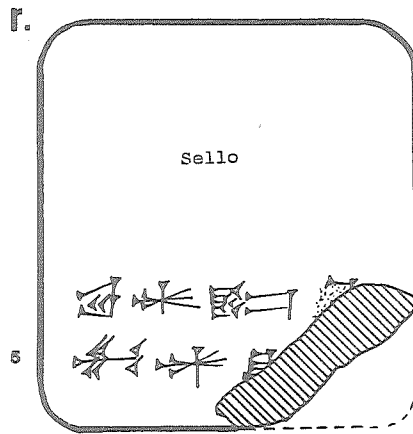
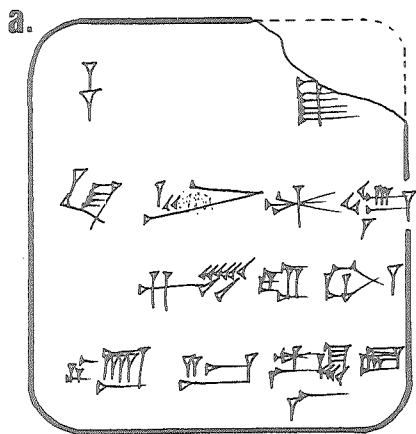

445 (MM 639)

Umma
Š32/ii 6 iii/-

445. Sello:

U²-sag-[il₂-la]
dumu Lu₂-²[nanna]
nu-ban₃-²da⁻ [nin³]

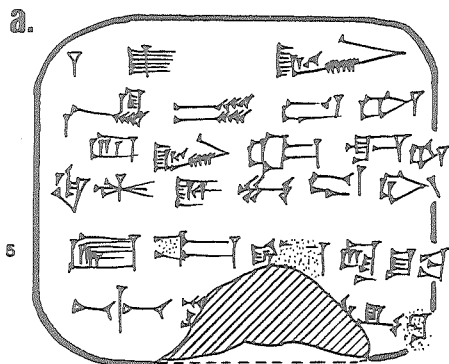

446 (MM 640)

Umma
AS1/viii/-

446. Sello:

Ur-²TUG₂.NUN-[ka]
dub-sar
dumu Ur-²Nin-[tu]
sa₁₂-du₂-ka

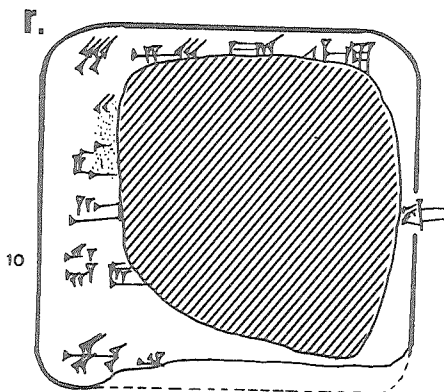
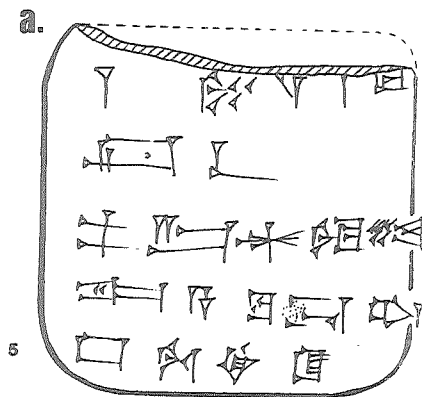

447 (MM 641)

Umma
ŠS8/-/-

447. Sello:

- i Šu-Šuen
lugal kal-ga
lugal Uri²-ma
lugal Šub-da limmu₂-ba
- ii G[u-du-du]
dub-sar
[dumu] Da⁻{da-ga}
[arad₂-zu]

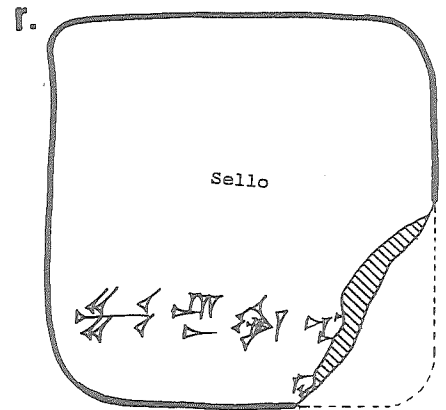
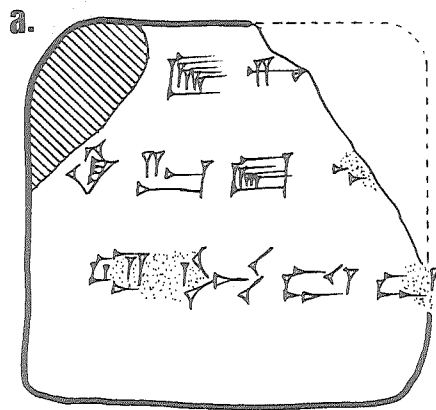

448 (MM 642)

Umma
Š43/-/-

448. Sello:

Ur-Šuen
[dub-sar]
[dumu] Ur-Š²gigir

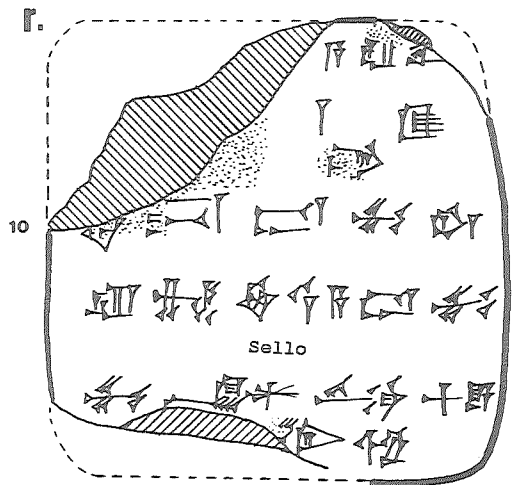
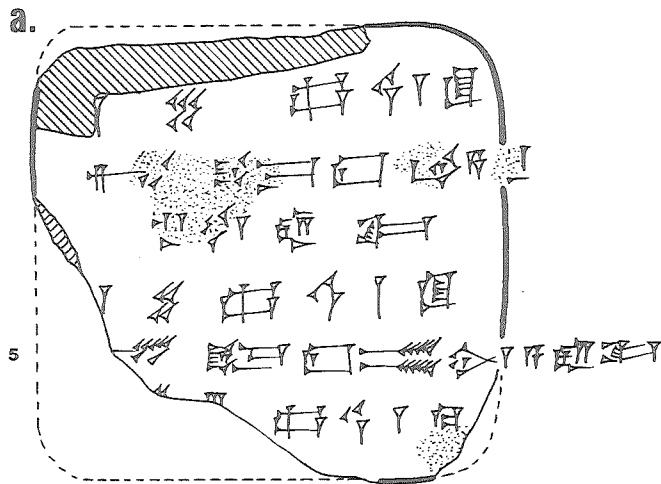

449 (MM 643)

Umma
ŠS1/i/-

Reverso anepigráfico sellado

449. Sello:

E₂-gal-e-si
dub-sar
dumu Ur-[ku₃]

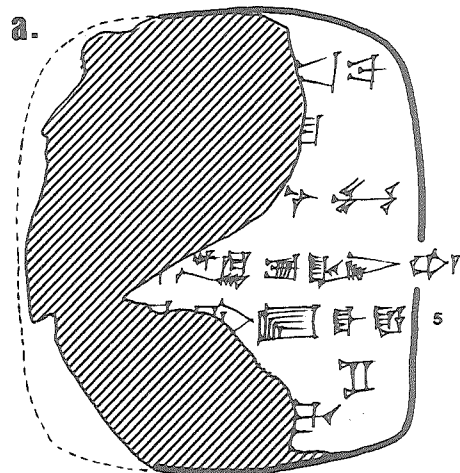

450 (MM 644)

Umma
ŠS4/-/18

450. Sello:

Ša[ra₂-he₂-ga₂]
dub-[sar]
dumu "Ur"-[mes]

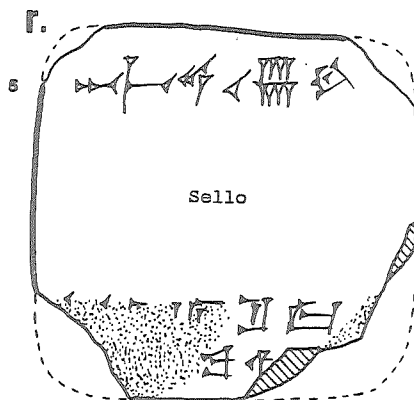
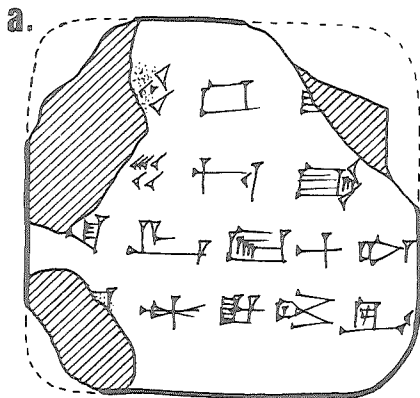

451 (MM 645)

Umma
Š41/xi/-

451. Sello:

Ur-d "[Inanna-Unu^u-ga²]"
dumu [...]
nu-banda₃ [...]

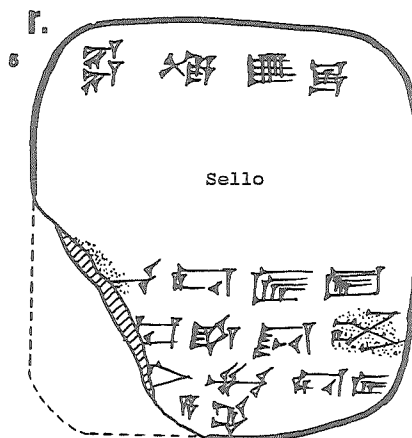
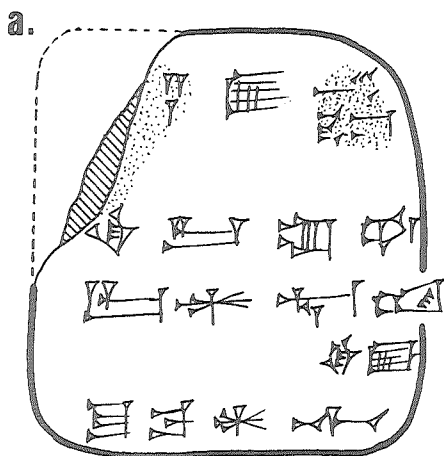

452 (MM 646)

Umma
[entre Š42-Š48]

Anverso destruido
Reverso anepigráfico sellado

452. Sello:

Lu₂-du₁₀-ga
dub-sar
dumu Ur-ni₉-gar

453 (MM 647)

Umma
ŠS1/[]

453. Sello:

Lugal-^re₂-[mah-e]
[dub-sar]
[dumu] Inim-²[Šara₂]
sa₁₂-^rdu₅-[ka]

Perdida aprox. media tablilla

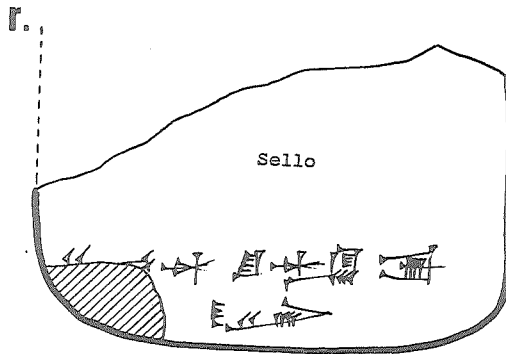
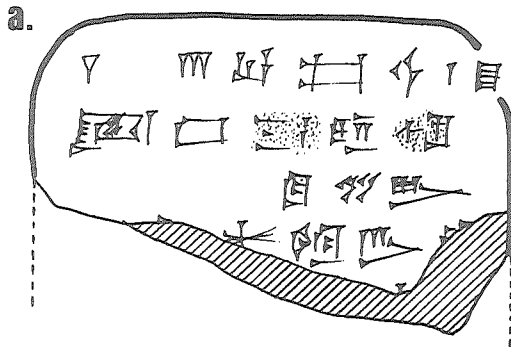

455 (MM 649)

Umma
Š35/v/-

Reverso anepigráfico sellado

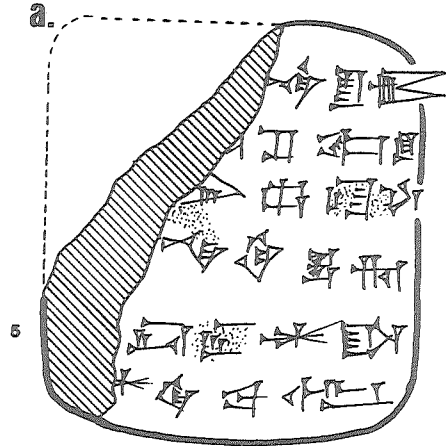

455. Sello:

Ur-²Suen
dub-[sar]
dumu Na-di

454 (MM 648)

Umma
ŠS.../-

454. Sello:

Ur-²Ša[ra]
dub-sar
dumu Lu₂-lu₅-[ni]

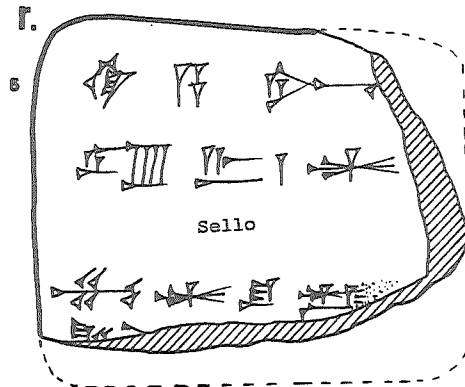
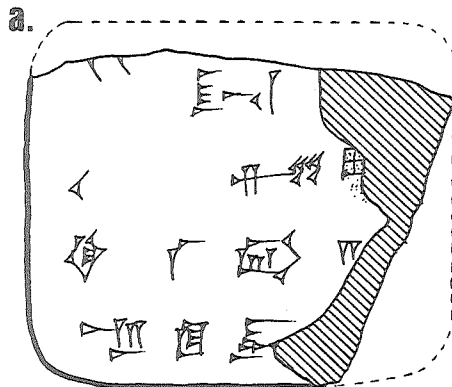

456 (MM 650)

456. Sello ilegible

Umma
[]/-/

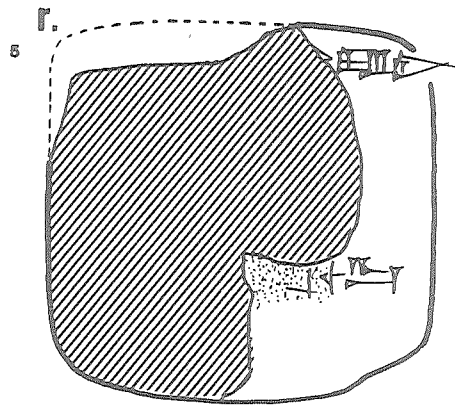
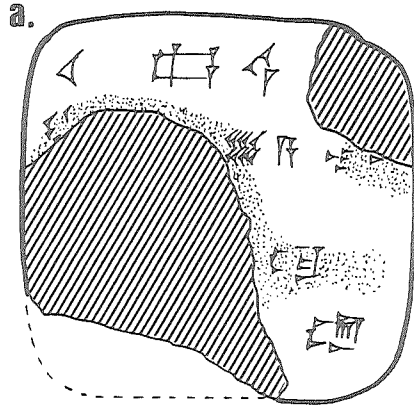

457 (MM 651)

457. Sello: /

Umma
Š36/viii/-

[D]a-du
"dumu" Ma-an-ba
aga₃-us₂ ens[i₂]

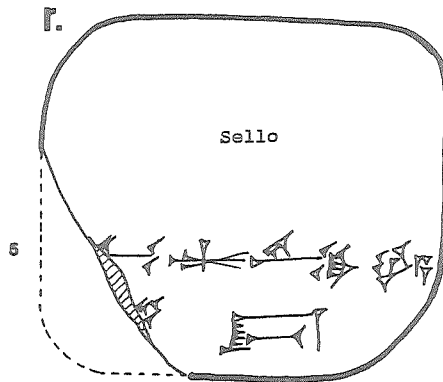
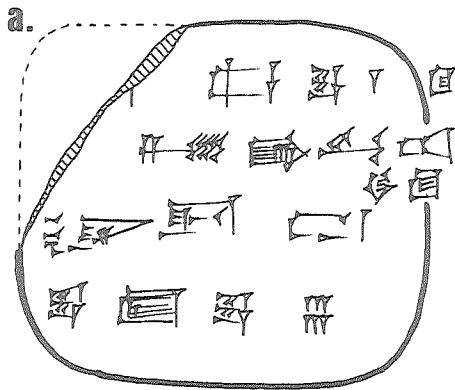

458 (MM 652)

458. Sello:

Umma
ŠS9/-/

Lugal-a₂-zi-da
dub-"sar"
dumu Da-[da]

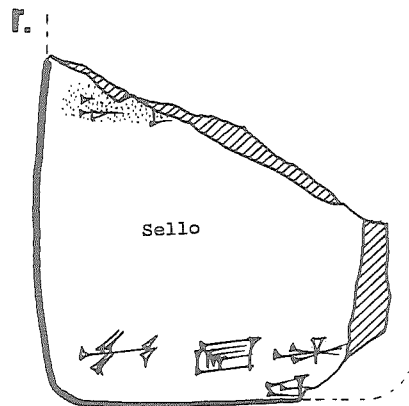
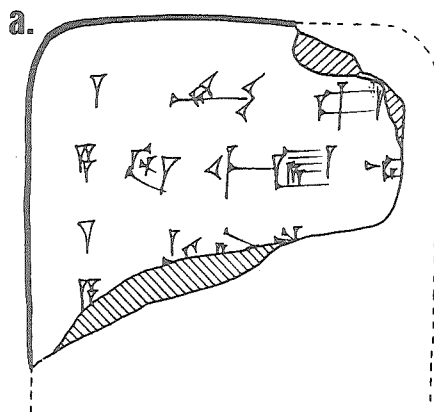

459 (MM 654)

459. Sello ilegible

Umma
ŠS9/-/-

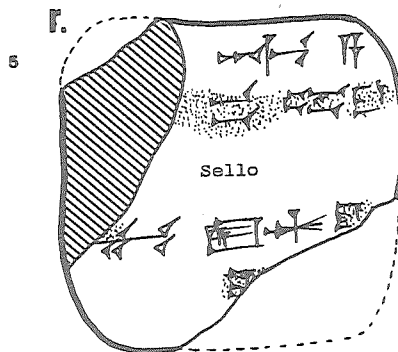
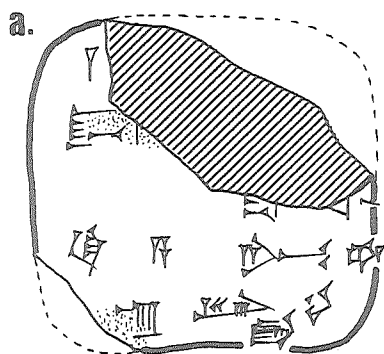

460 (MM 655)

460. Sello:

Umma
[]/iii/-

[Lu₂-he₂]-gal₂
dumu Ur.²ⁱgigir
m[u-sar] ⁴Sara₂

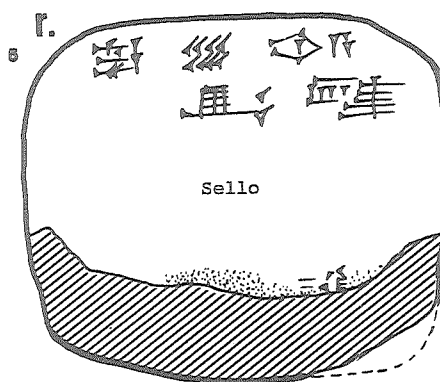
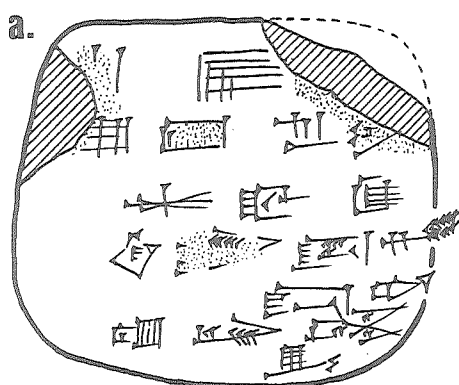

461 (MM 656)

Umma
AS8⁷/viii/-

461. Sello:

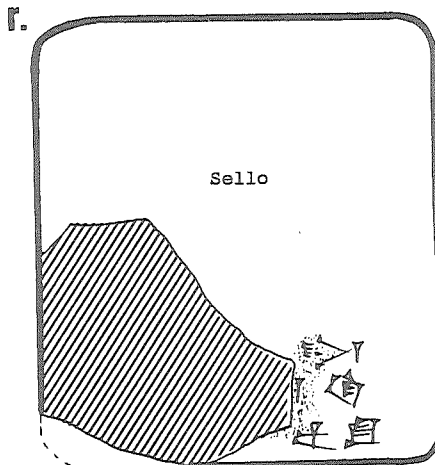
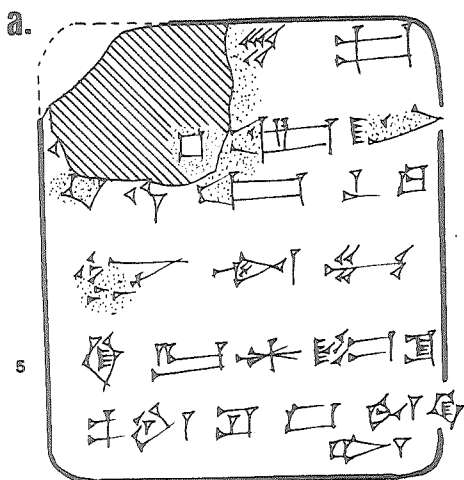

i ⁴Amar-⁴Suen
nita kal-ga
lugal Uri₂/⁴ⁱ-ma
lugal ⁴Ub-/da limmu₂-ba
ii Ba-ba-ti
dub-sar
arad₂-zu

462 (MM 657)

Umma
Š38/ix/[?]

462. Sello:

Ur-²Nisaba
dub-sar
dumu Ur-ni₉-gar

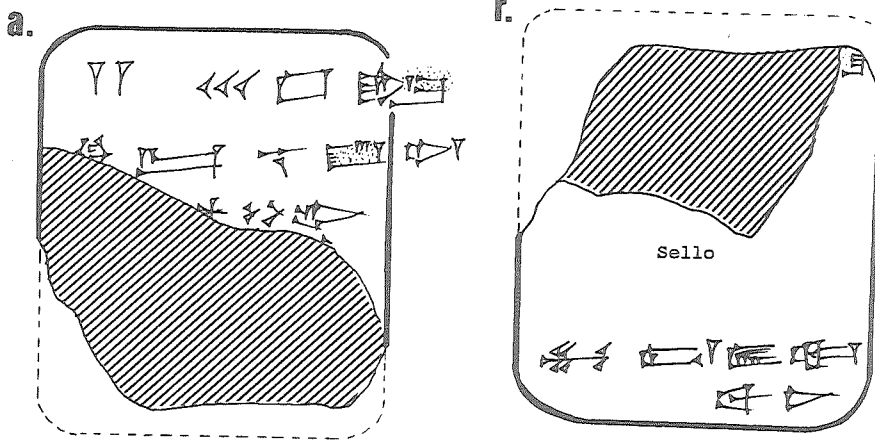

463 (MM 659)

Umma
ŠS1/-/

463. Sello:

Ur-²Sul-pa-e₃
dub-sar
dumu Lugal-ku₃-ga-ni

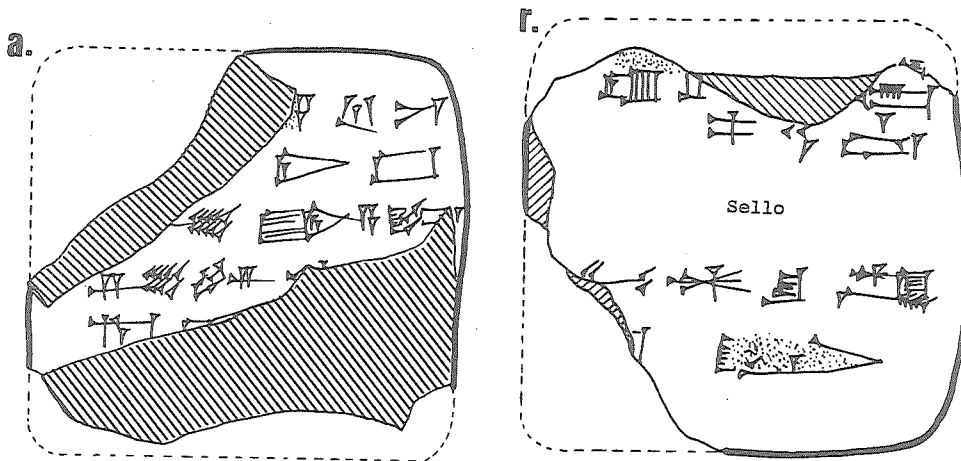

464 (MM 660)

Umma
AS9/[]

464. Sello:

Lugal-e-ba-an-š[a₆]
dub-[sar]
dumu Ur-²Iš[taran]

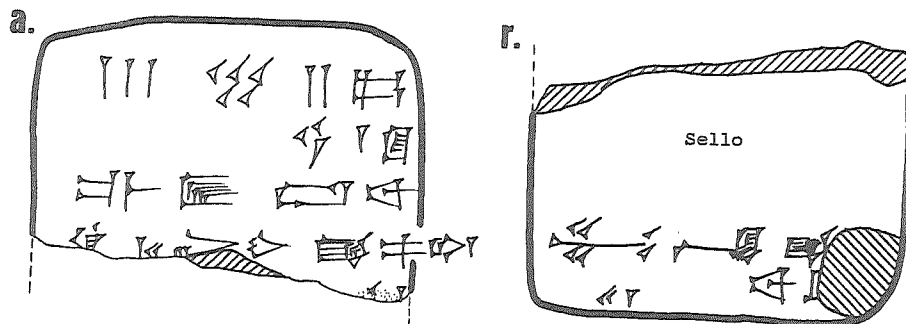

465 (MM 661)

Umma
[]

Quizás misma tablilla que n° 403 y/o n° 404
Reverso destruido

465. Sello:

Lu₂-^dH[a]-i[a₃]
dub-[sar]
dumu Ur-e₁₁-e kuš,

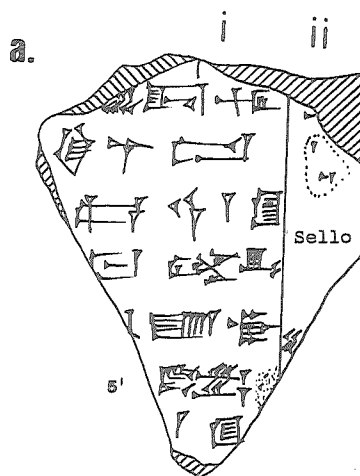

466 (MM 662)

Umma
?/xiii/-

466. Sello:

[In]im-^dInanna
dumu Lugal-i[ti-da]

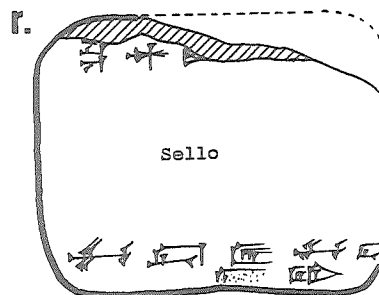
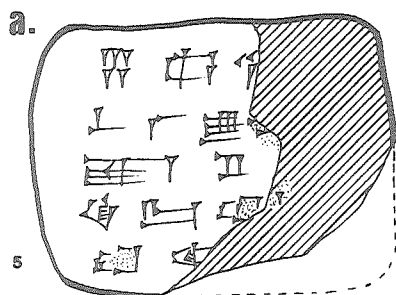

467 (MM 663)

Umma
ŠS1/viii/-

467. Sello:

Nin₉-^rhi₂-[li₂-a]
dam A-a-kal-la
dumu Ur-^dDa-mu

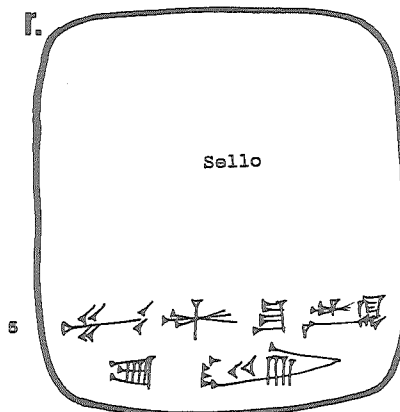
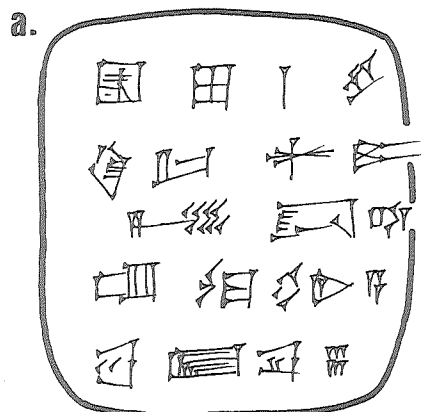

468 (MM 664+1138)

Umma
AS7/-/-

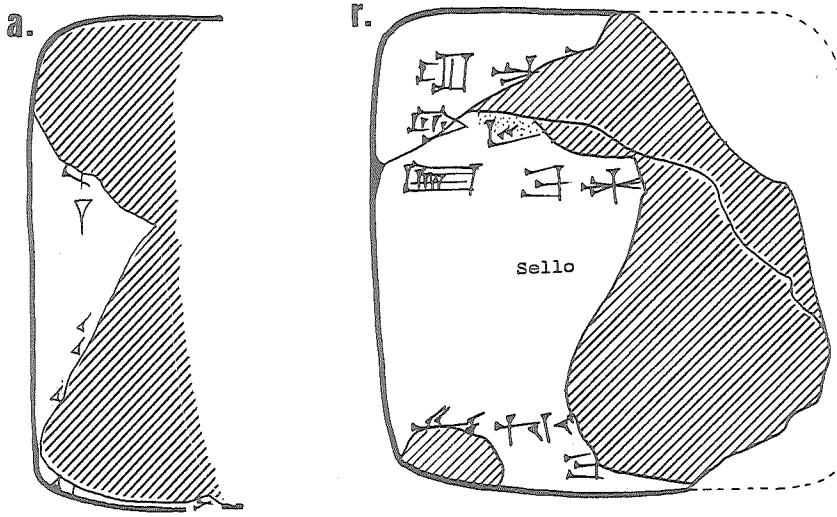

468. Sello:

Lu₂-^dTUG₂.AN-ka
dub-s[ar]
dumu Lu₂-^d[Šara₂]
sa₁₂-[du₅-ka]

469 (MM 665)

Umma
?/-/-

469. Sello:

[Lu₂-^dŠara₂]
[dub]-sar
dumu Uru-bar-r[a']

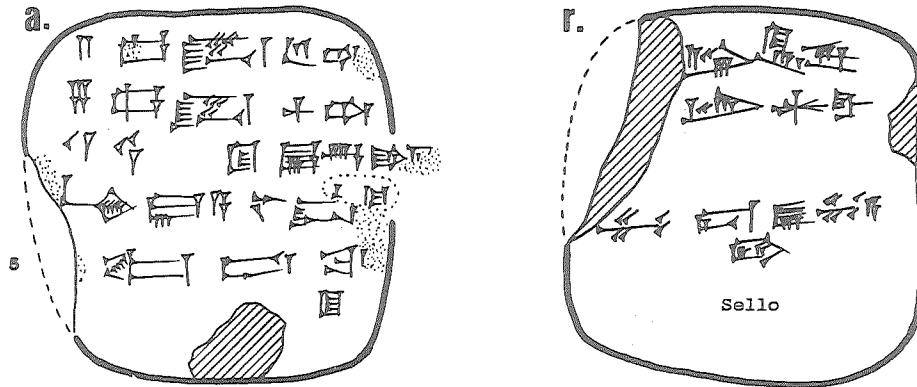

470 (MM 666)

Umma
AS9/-/-

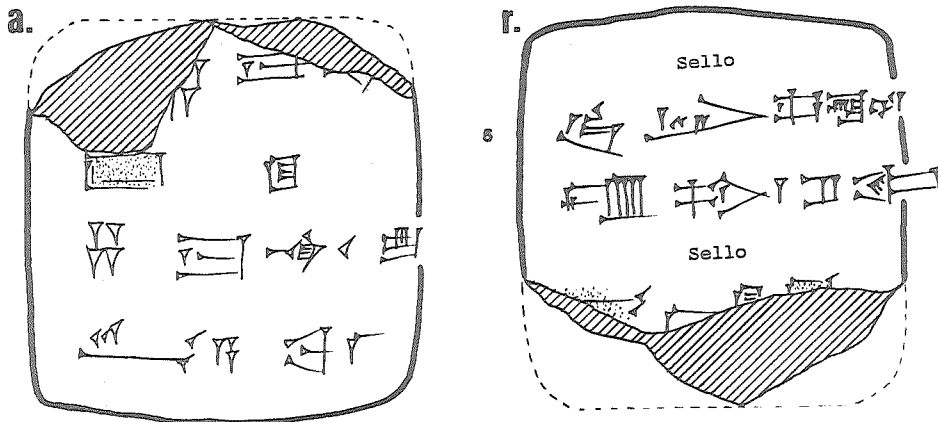

470. Sello:

i ^dSu-^dSuen
lugal kal-ga
lugal Uri₅/^{ki}-ma
lugal ^dUb-/da limmu₂-ba
ii A-a-[kal-la]
ensi₂
Umma^{ki} /arad₂-zu

471 (MM 667)

Umma
AS5/x/-

471. Sello:

Arad₂-m[u]
dub-[sar]
dumu Ur-ni₂-[gar kuš₂]

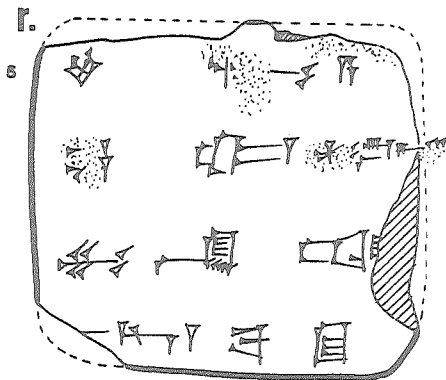
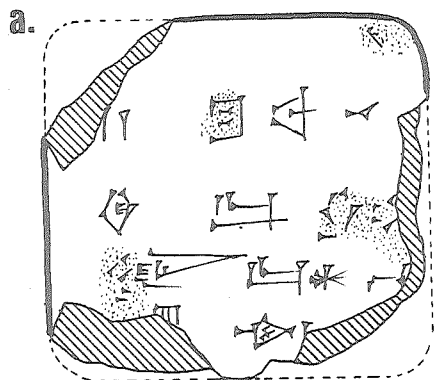

472 (MM 668)

Umma
ŠS.../i 6 iii/-

472. Sello:

Al-[la]
agrig^d[...]
dumu Ba-š[a₆]

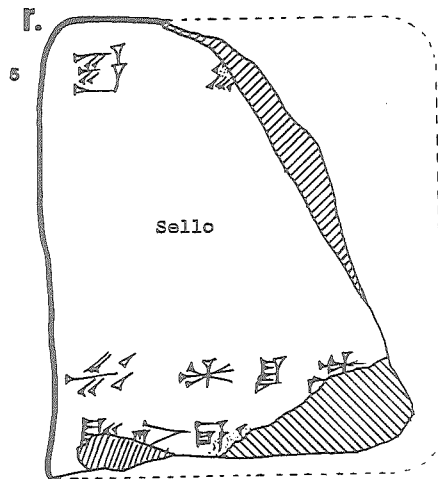
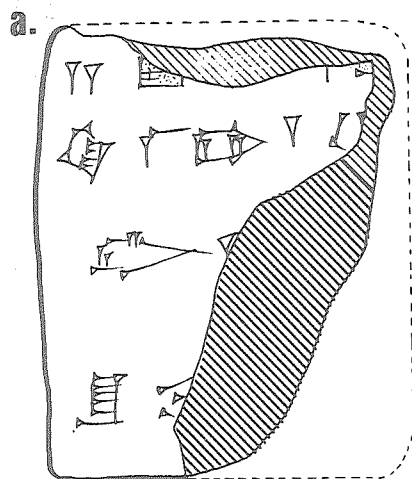

473 (MM 669)

Umma
ŠS2/-/-

473. Sello:

Šeš^h-kal-[la]
dub-[sar]
dumu Ur-^eEn-lil₂-[la₂]

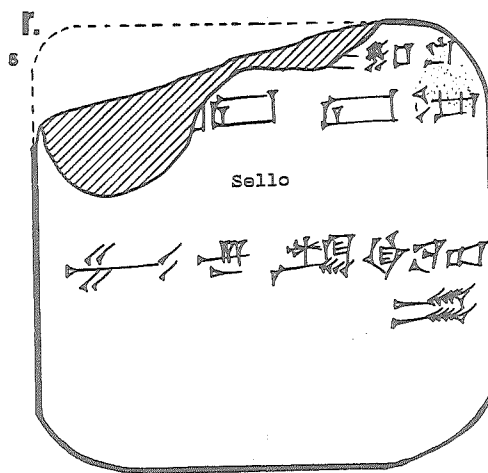
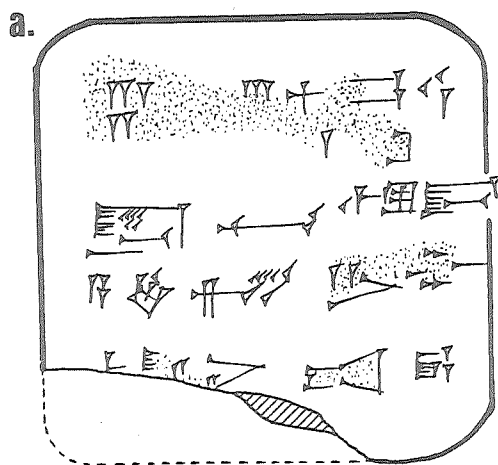

474 (MM 670)

Umma
AS5/x/-

474. Sello:

Arad₂-mu
dub-[sar]
dumu Ur-ni₉-gar k[uš₇]

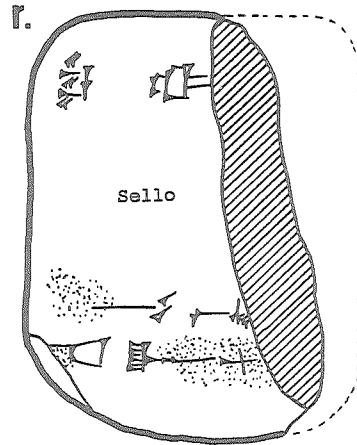
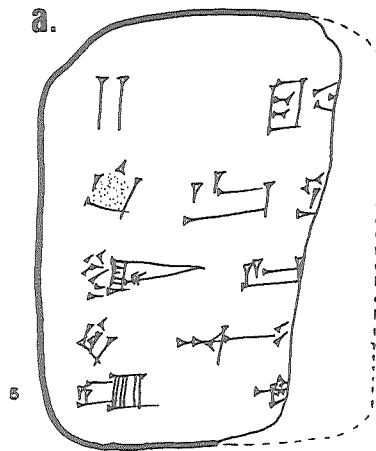

475 (MM 671)

Umma
AS4/-/-

475. Sello:

Gu-u₂-gu-a
dub-sar
dumu Ma-an-sum

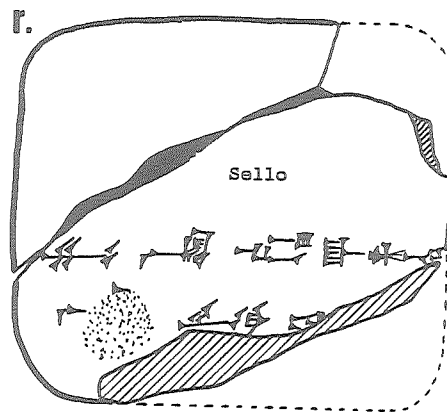
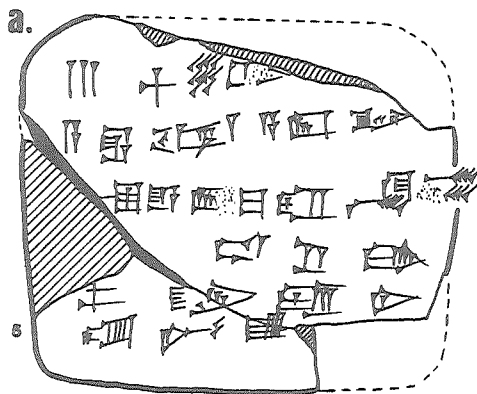

476 (MM 672)

Umma
[]

Perdida aprox. media tablilla

476. Sello:

Lugal-e₂-[mah-e]
dub-[sar]
dumu Inim-Ša[ra₂]
sa₁₂-du₅-[ka]

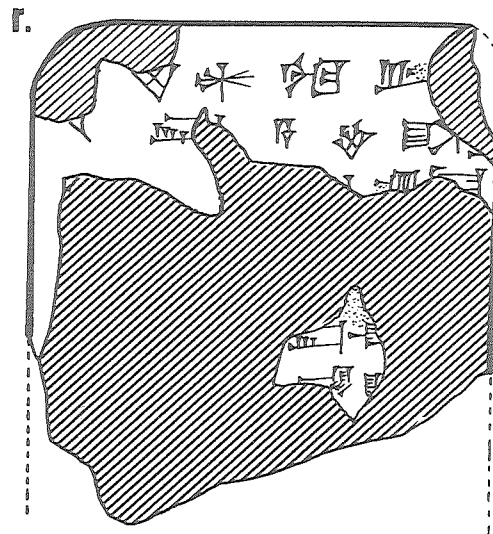
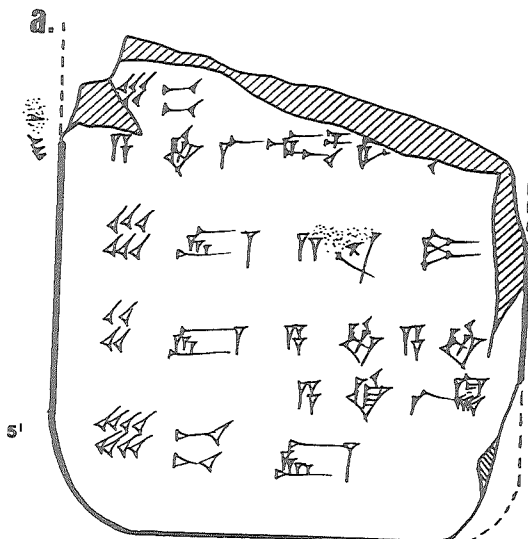

477 (MM 673)

Umma
 ŠS... 6 IS.../-/

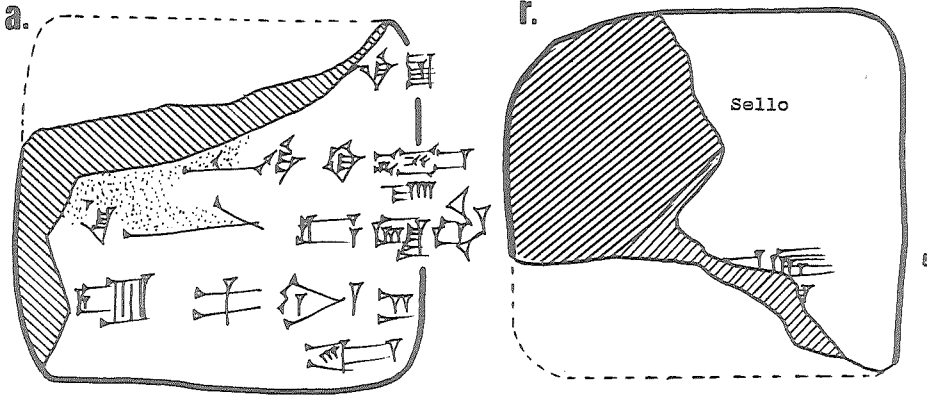

477. Sello:

- i [Šu-Šuen]
 lugal kal-ga
 lugal Uri₅^{ti}-ma
 lugal Ub-/da limmu₂-ba
- ii [A]-a-kal-la
 [ensi₂]
 [Umma^{ki}]
 arad₂-[zu]

478 (MM 674)

Umma
 Š38/vi/-

478. Sello:

Giri₃-ne₂-i₃-ša₆
 dub-sar
 dumu Ur-e₁₁-[e']

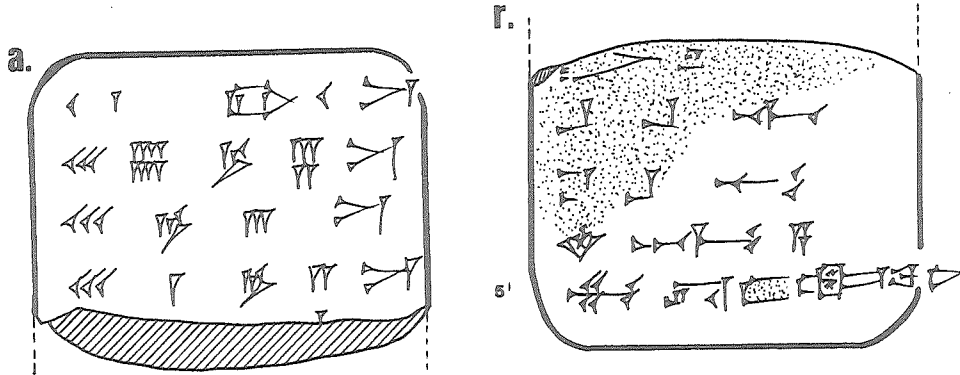

479 (MM 675)

Umma
 AS9/-/ ([]-xii)

479. Sello:

[Šeš]-kal-[la]
 [dub-sar]
 [dumu U]r-En-[lil₂-la₂]

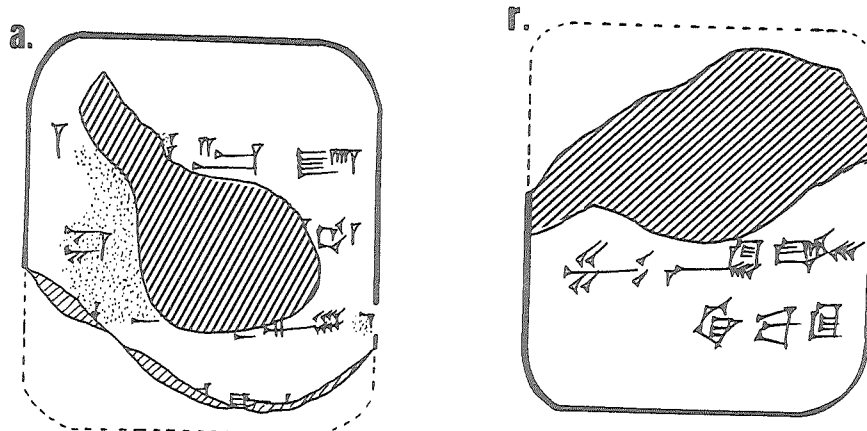

480 (MM 676)

Drehem
ŠS1/vii/24,27,[]

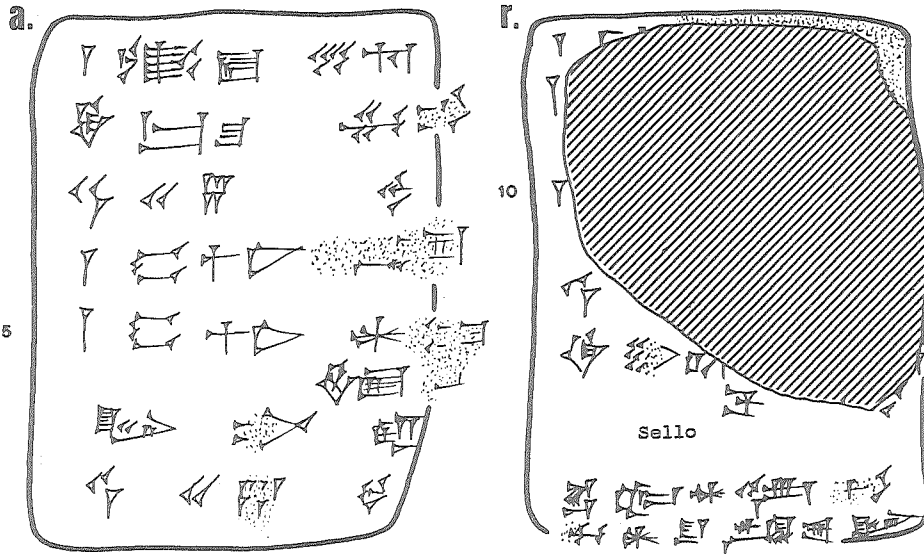

480. Sello:

[²Su-⁴Suen]
lugal Uri₅^{ki}-ma
lugal ⁴Ub-da [limmu₂-ba]
Ur-⁴Sul-pa-[e₃]
dub-sar
dumu Ur-⁴Ha-ia₃
arad₂-z[u]

481 (MM 677)

Umma
ŠS9/-/-

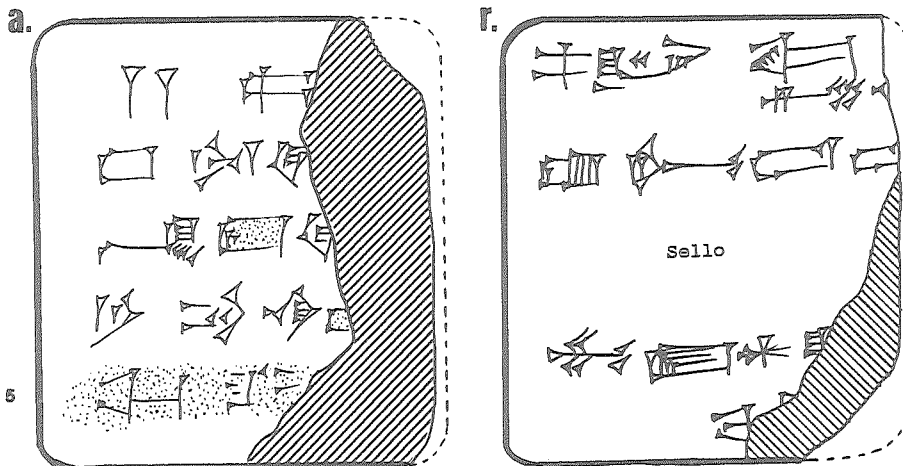

481. Sello:

i ⁴Su-⁴Suen
lugal kal-ga
lugal Uri₅^{ki}-ma
lugal ⁴Ub-/da limmu₂-ba
ii Gu-du-du
dub-sar
dumu Da-da-ga
arad₂-zu

482 (MM 678)

Umma
ŠS1⁷/-/-

482. Sello:

Ur-lugal
dub-sar
dumu Da-a-gi₄

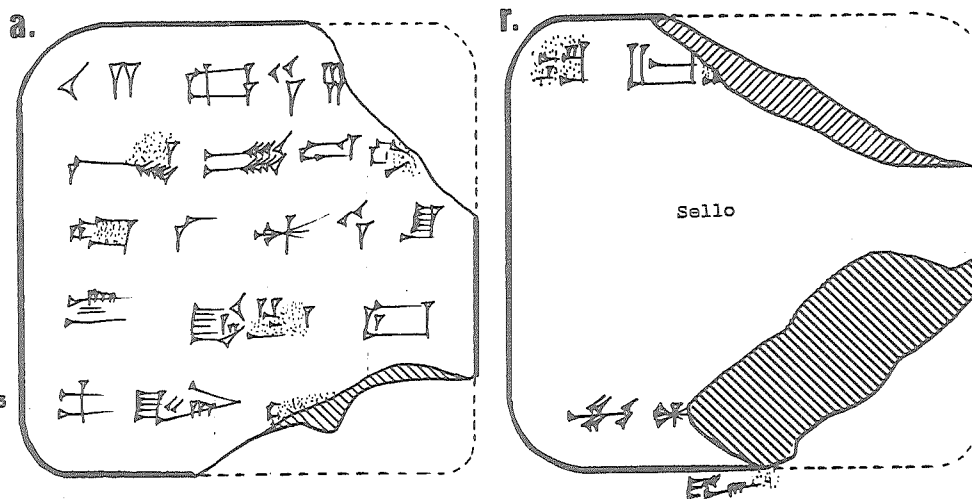

483 (MM 679)

Umma
ŠS1/xi/-

483. Sello:

Nin₉-hi₂-[li₂-a]
dam A-a-kal-la
dumu Ur-^dDa-[mu]

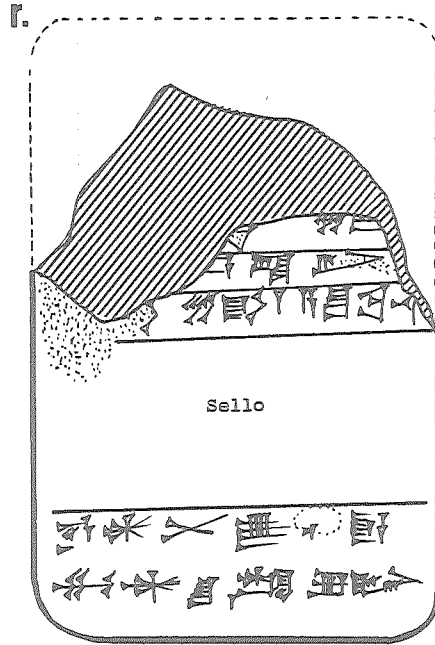
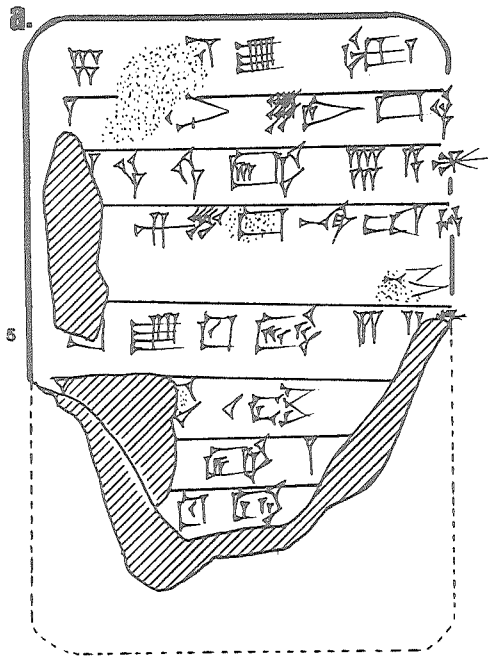

484 (MM 680)

Umma
Š48/-

Reverso anepigráfico sellado

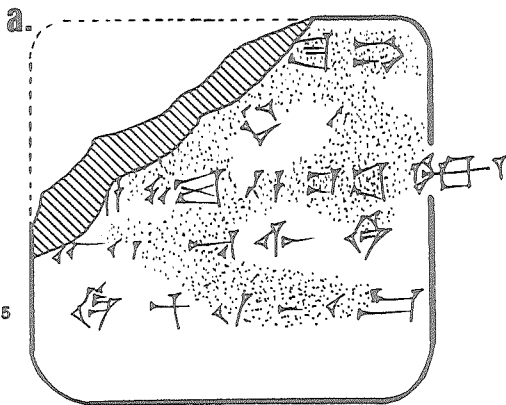

484. Sello:

A-tu
dub-sar
dumu Šeš-kal-la

485 (MM 681)

Umma
ŠS3/-

485. Sello:

^dSara₂-kam
dub-sar
dumu Lugal-^{si}kiri₆

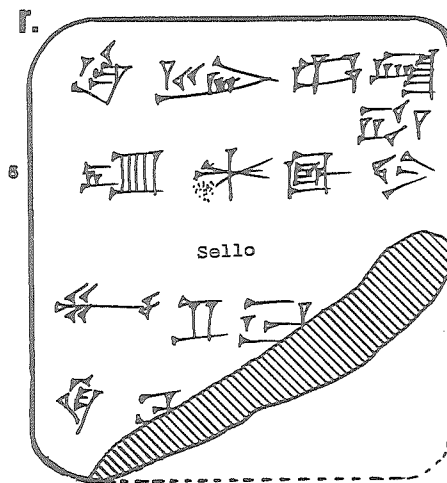
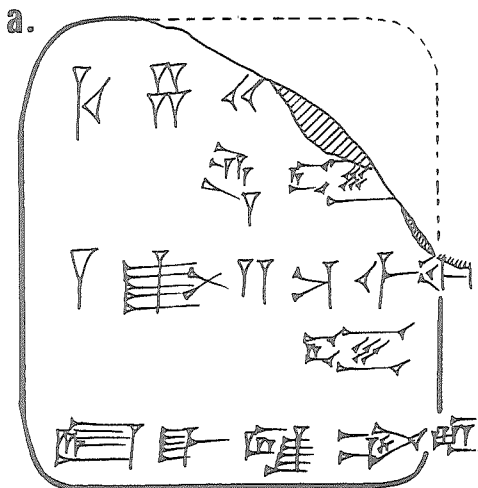

486 (MM 682)

Umma
Š46/-/-

486. Sello:

I₂-kal-[la]
dub-sar
dumu Lu₂-ša₆-ga

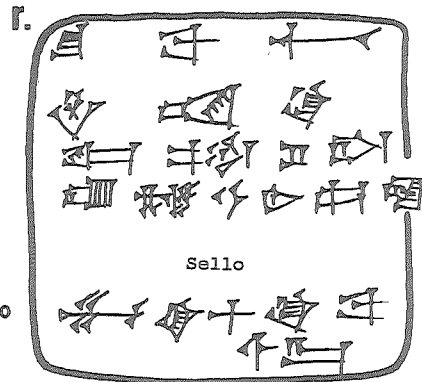
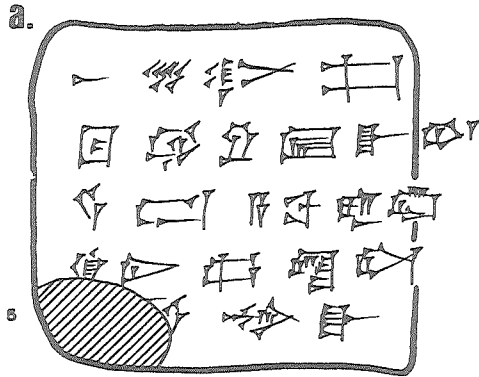

487 (MM 683)

Umma
AS6/-/-

487. Sello:

Lu₂-ša₆-i₃-zu
dub-sar
dumu A-kal-la

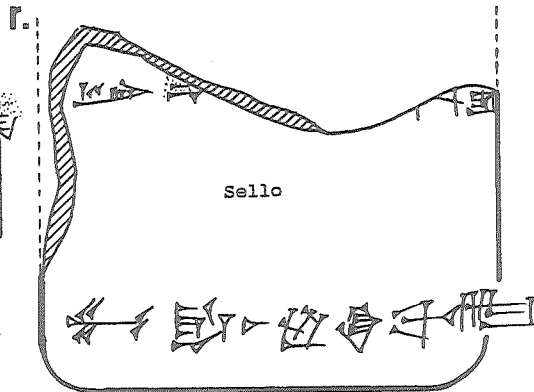
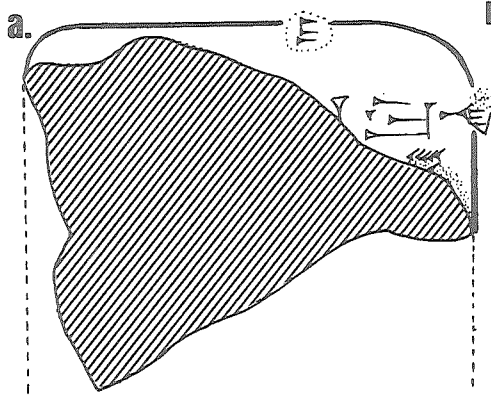

488 (MM 684)

Umma
ŠS6/iv/-

488. Sello:

Lu₂-kal-la
dub-sar
dumu Ur-e₁₁-e kuš,

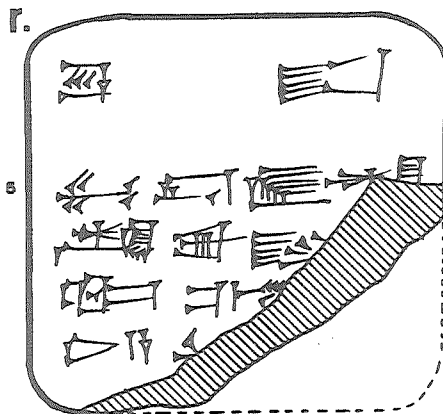
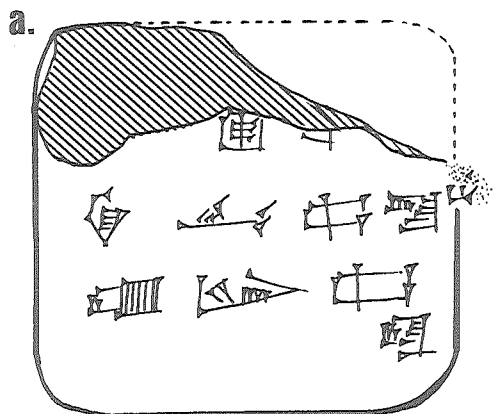

489 (MM 685)

Umma
AS8/-/

489. Sello:

Lu₂-igi-ša₆-ša₆
dub-sar
dumu Ur-²gigir

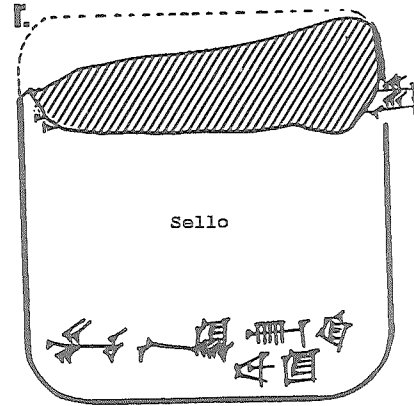
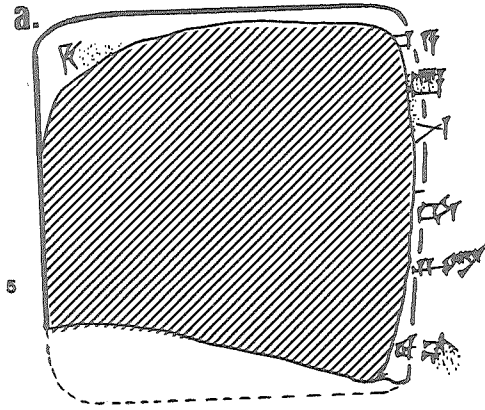

490 (MM 686)

Umma
AS9/-/

490. Sello:

Gu-u₂-gu-a
dub-sar
dumu Ma-an-sum

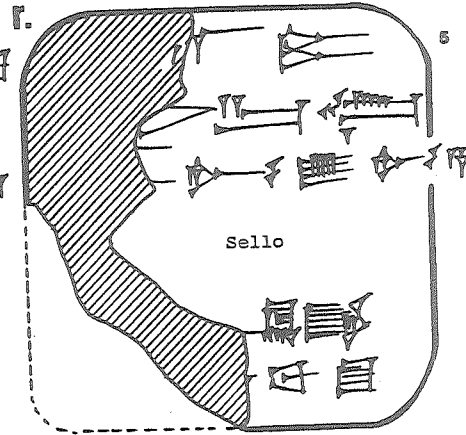
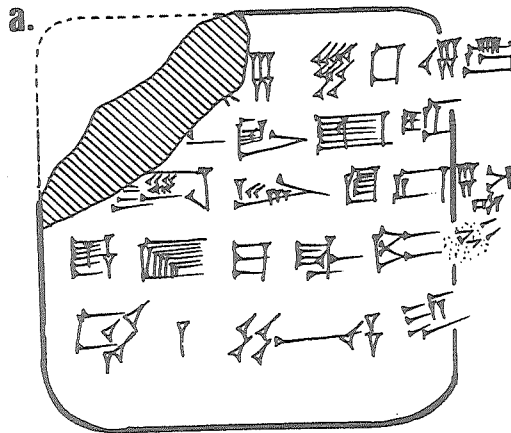

491 (MM 687)

Umma
Š45 6 AS2/-/

491. Sello:

A-kal-la
dub-sar
dumu Lugal-e₂-mah-e

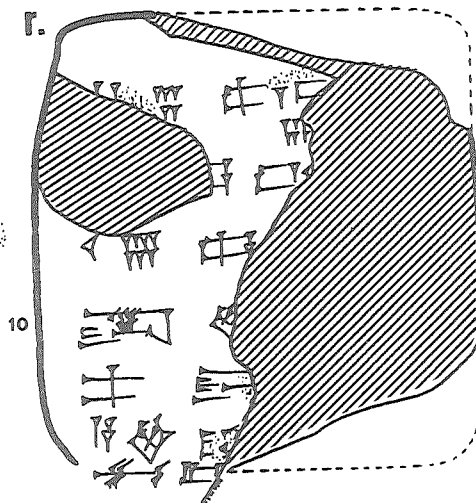
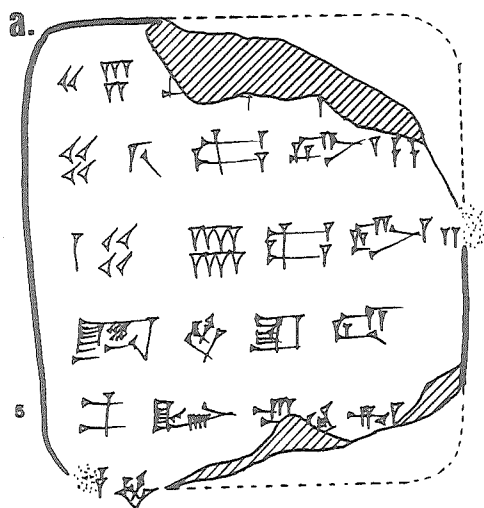

492 (MM 688)

Umma
Š48/-/-

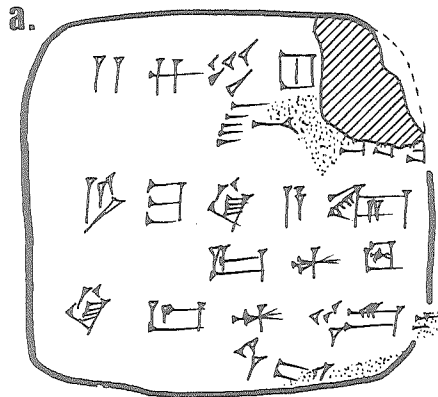

492. Sello:

Lugal-inim-gi-na [dub-sa]r
dumu Lugal-nesag₂[e]

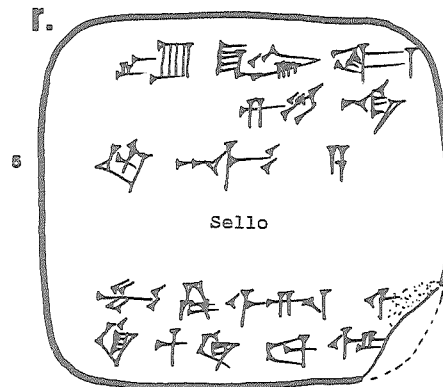

493 (MM 689)

Umma
AS9/-/-

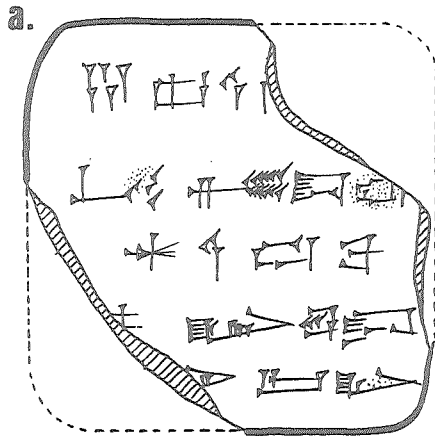

493. Sello:

Da-da-ga
dub-sar
dumu Ur-ni₂/-gar kuš₂

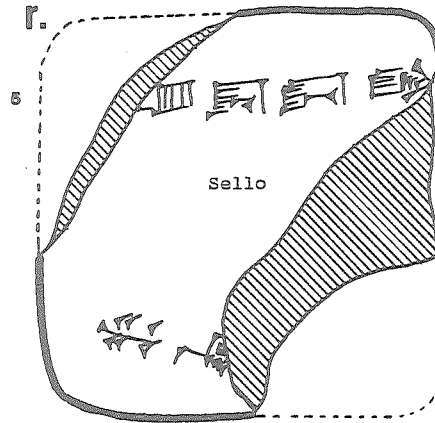

494 (MM 690)

Umma
ŠS3/v/-

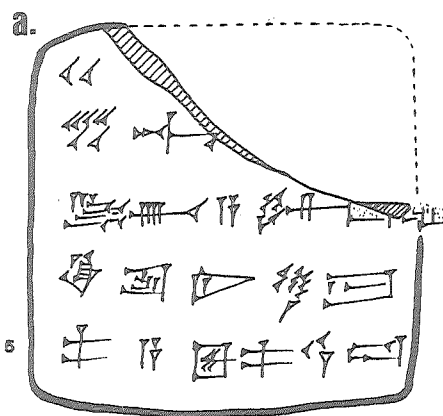

494. Sello:

Šeš-kal-la
dub-sar
dumu Tir-gu

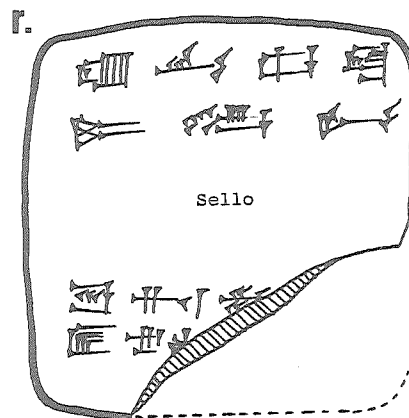

495 (MM 691)

Umma
ŠS.../xiii/2

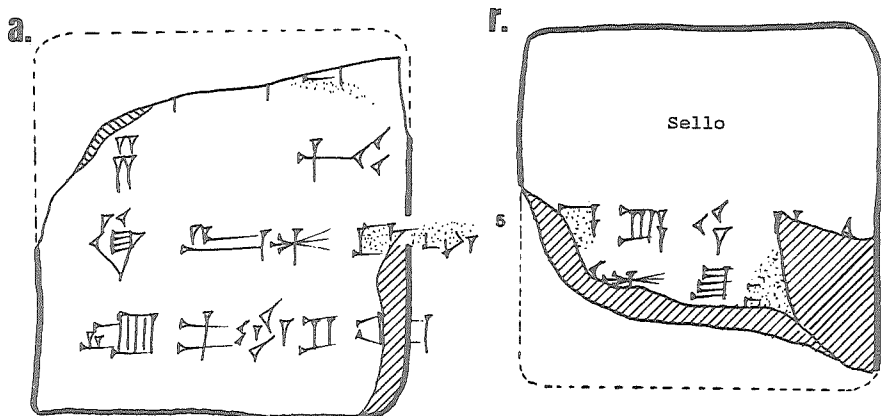

495. Sello:

- i Šu-Šuen
lugal kal-ga
lugal Uri₂/^{ki}-ma
lugal Ub-/da limmu₂-ba
- ii A-a-kal-la
ensi₂
Umma^{ki}
arad₂-zu

496 (MM 692)

Umma
AS1/v/-

496. Sello:

Ab-ba-gi-na
dub-sar
dumu Lugal-ma₂-gur₂-re

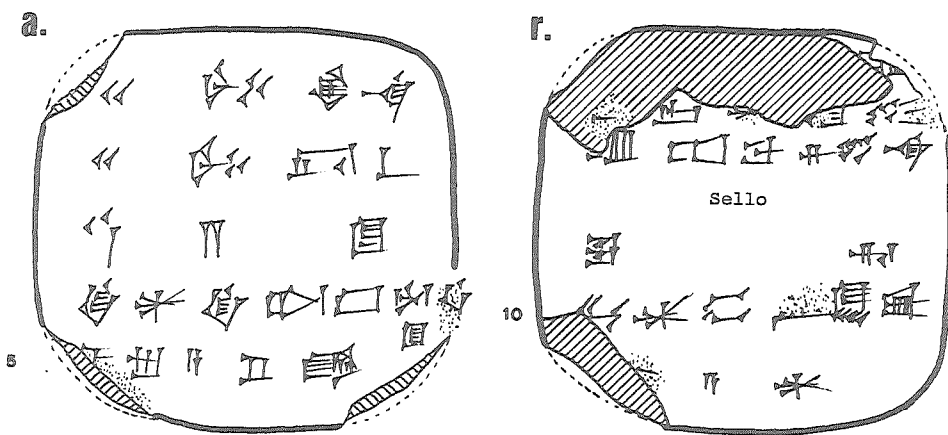

497 (MM 693)

Umma
ŠS.../-/-

497. Sello:

Šeš-a-ni
dub-sar
dumu Da-da

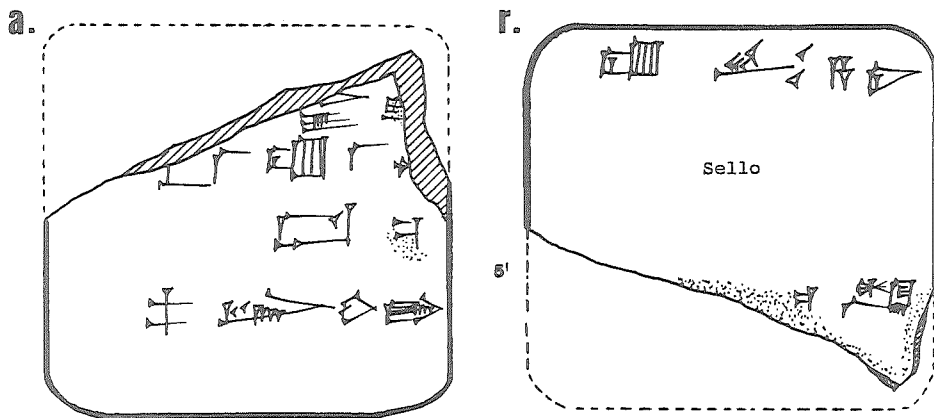

498 (MM 694)

Umma
Š35/-/-

498. Sello:

Dingir-ra
dub-sar
dumu Lu₂-ga

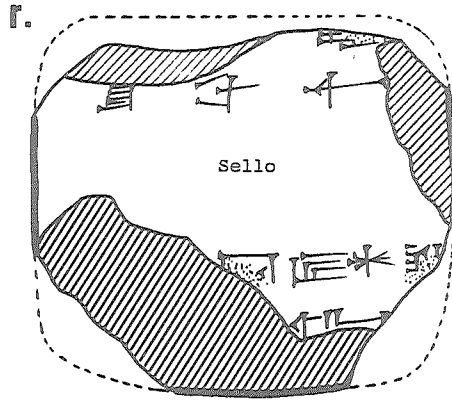
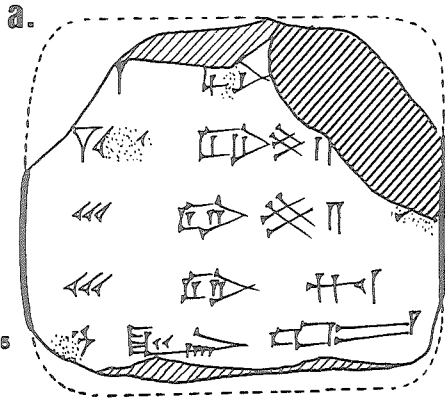

499 (MM 695)

Umma
AS2/-/-

499. Sello:

Lugal-si-NE-[e]
dub-sar
dumu Lugal-bad₃

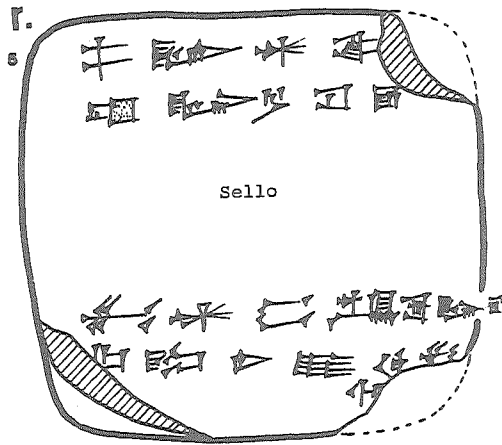
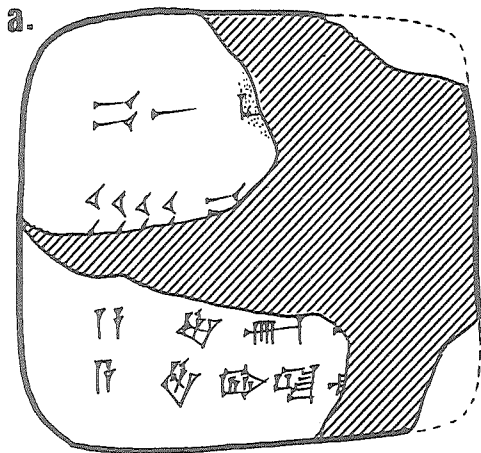

500 (MM 696)

Umma
Š35/-/-

500. Sello:

Ur-⁴Šara₂
dub-sar
dumu Lugal-na[nga]
nu-banda₃ gu₄ ⁴Šara₂

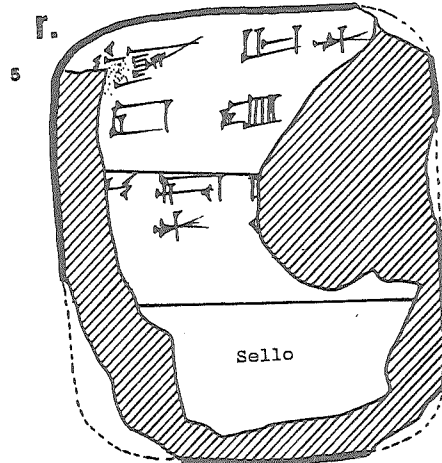
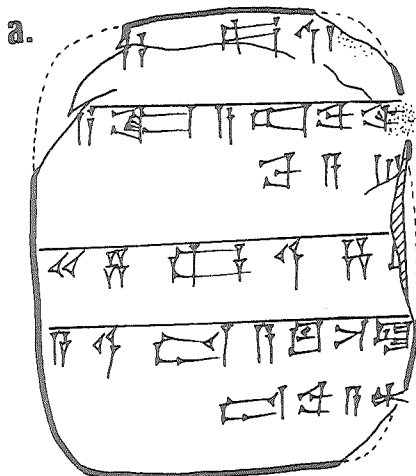

501 (MM 697b)

Umma
[]/iii/-

501. Sello:

Unken-ne₂
dub-sar
dumu Ur-^{III}gigir

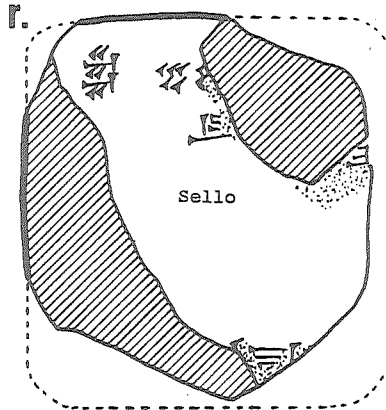
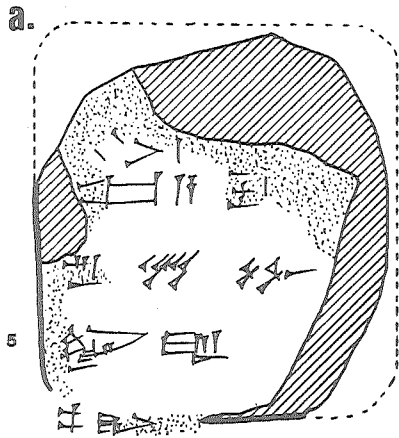

502 (MM 698)

Umma
AS7/- (ix-xii,ix-xi)

502. Sello:

Ku₂-^rga-ni^r
dub-[sar]
dumu A-g[ub-ba]

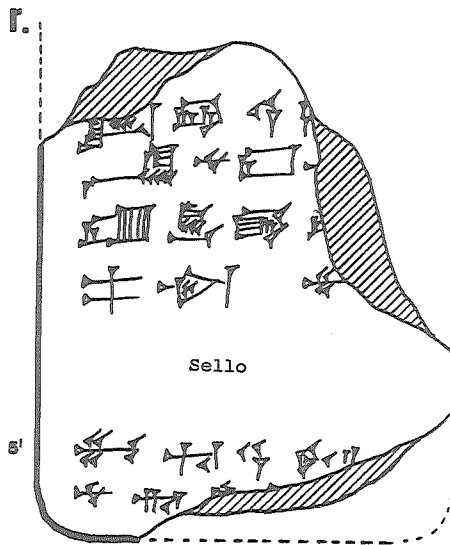
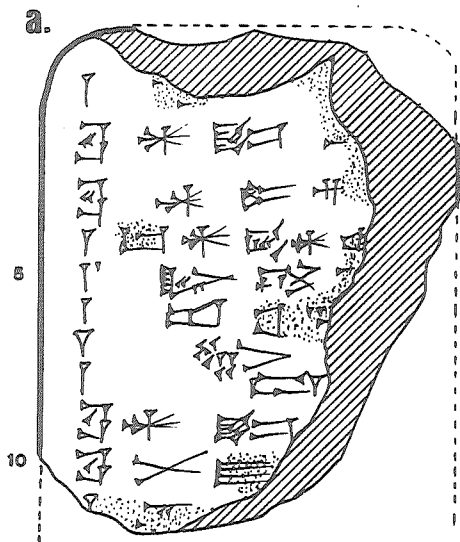

503 (MM 699)

Umma
ŠS7/xii/-

Perdido aprox. 1/3 de la tablilla

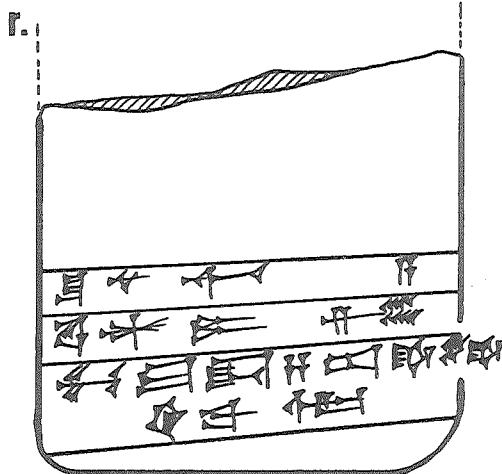
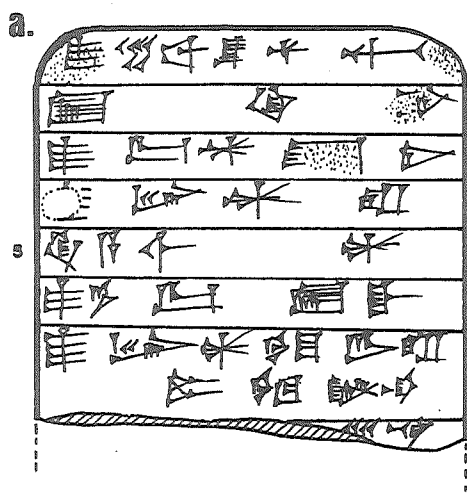

504 (MM 700)

Umma
[]

504. Sello:

Lu₂-^d[Šara₂]
dub-[sar]
dumu Ur-^{su}gig[ir]

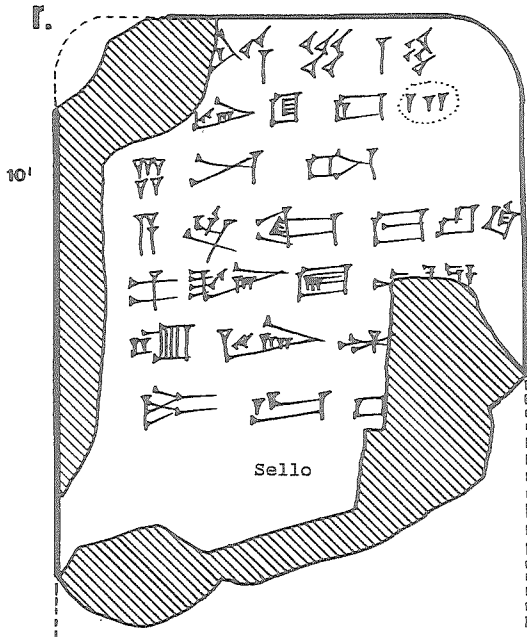
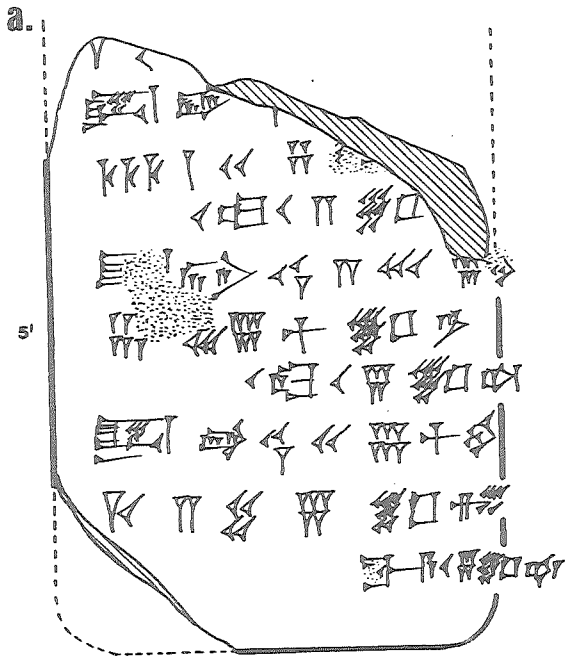

505 (MM 701)

Umma
[]/iii/- (iv)

505. Sello:

Ur-^dBa-^rba₆-^r
dumu Da-da
dub-[sar]

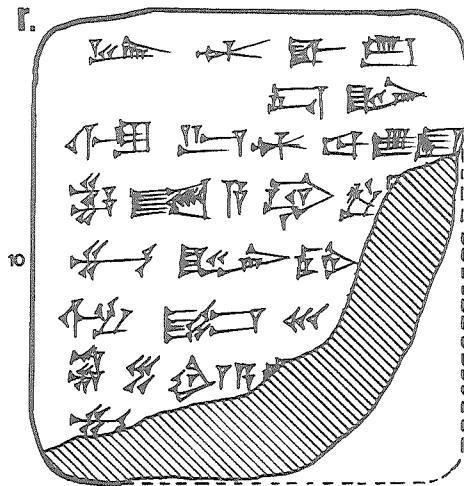
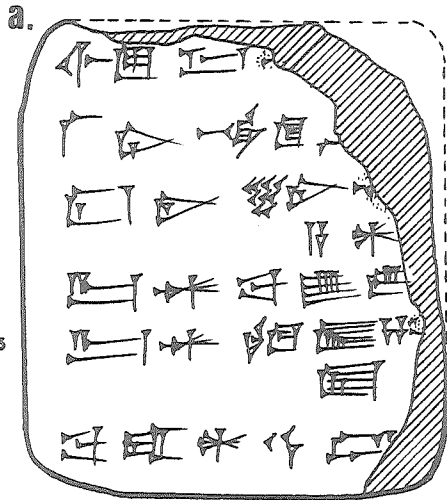

506 (MM 702)

Umma
[]/(iii/15-viii/8)

506. Sello:

Bi₂-du₁₁-[ga]
dub-sar
dumu La-a-ša₆

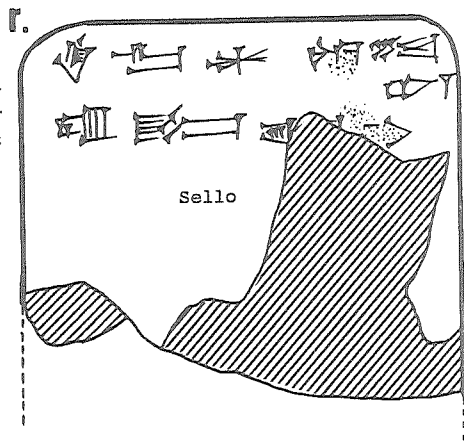
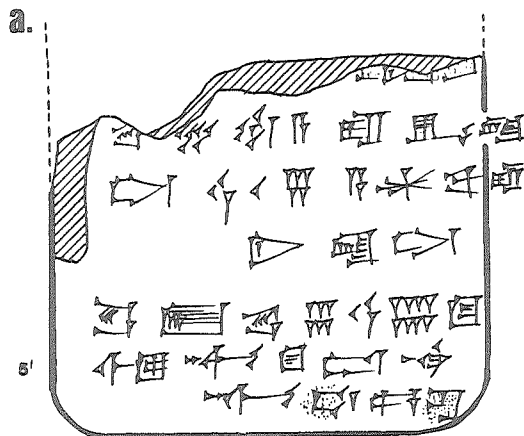

507 (MM 703)

Umma
ŠS41-/

507. Sello:

Arad₂-hul₂-la
dub-sar
dumu Ur-^dUtu

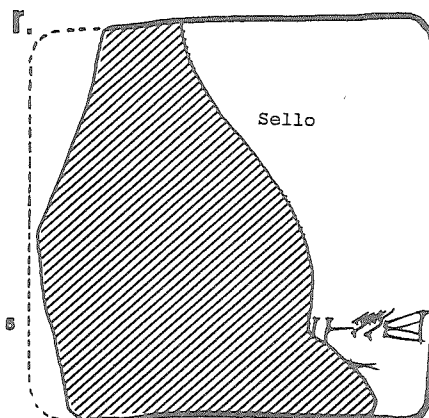
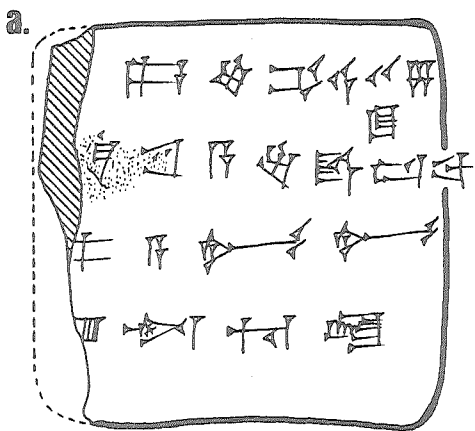

508 (MM 704)

Umma
ŠS1 6 IS1/[]

508. Sello:

- i ^dSu-^dSuen
lugal kal-ga
lugal Uri₂/^{ki}-ma
lugal ^dUb-/da limmu₂-ba
- ii A-a-ka[l-la]
en[si₂]
Umm[a^{ki}] /arad₂-[zu]

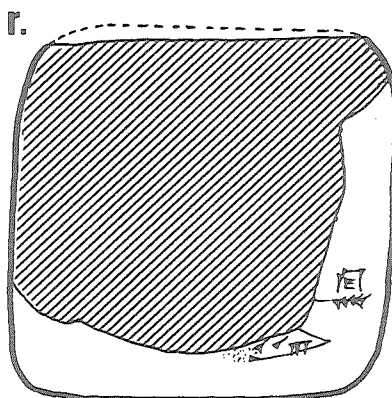
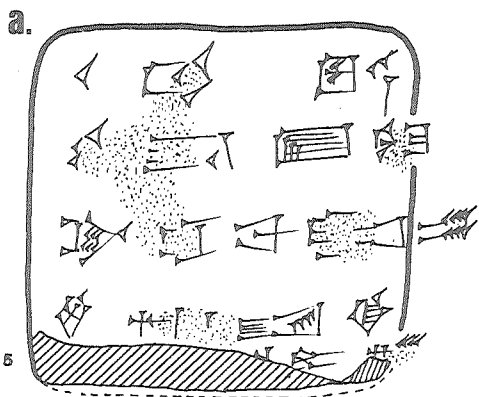

509 (MM 705)

Umma
AS91-/

509. Sello:

Uš-mu
dub-sar
dumu Lugal-ša₆-ga

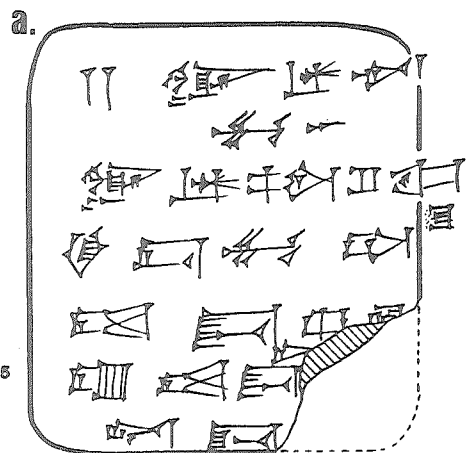

510 (MM 706)

Umma
Š41/vi/-

510. Sello:

Lugal-e₂-mah-[e]
dub-sar
dumu Inim-Šara₂
sa₁₂-du₅-[ka]

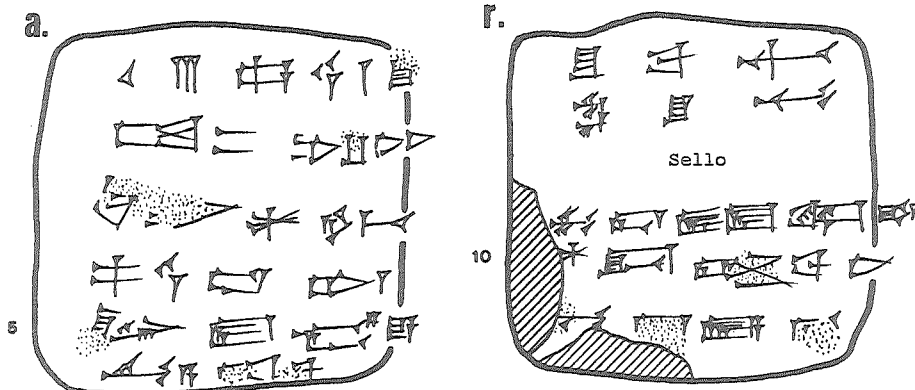

511 (MM 707)

Umma
AS1/-/-

512 (MM 708)

Umma
[]

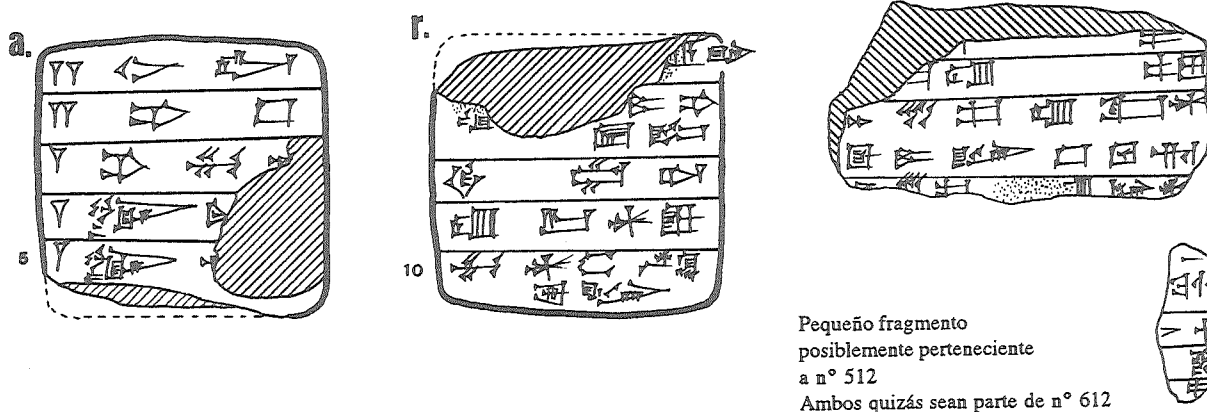

513 (MM 709)

Umma
AS9/-/-

513. Sello:

Lugal-e-ba-an-š[a₆]
dub-[sar]
dumu Ur-Š[arān]

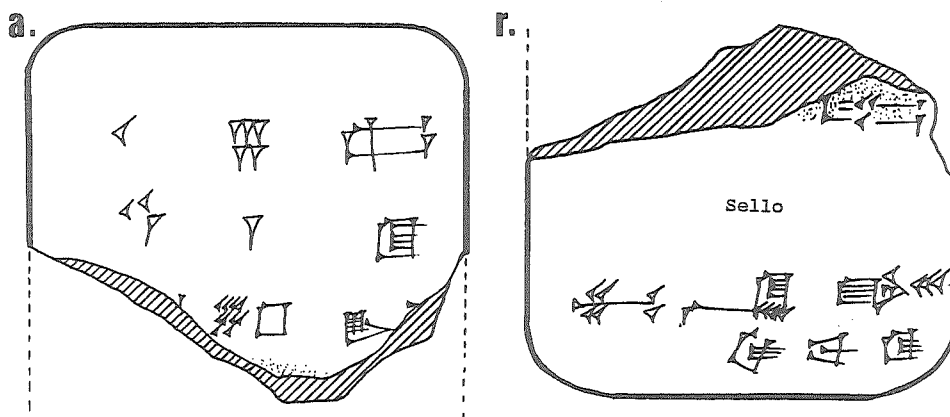

514 (MM 710a)

Umma
S40/xii/-

514. Sello:

[Arad₂-mu]
[dub-sar]
[dumu] ʾUr²-ni₂-[gar (kuš₂)]

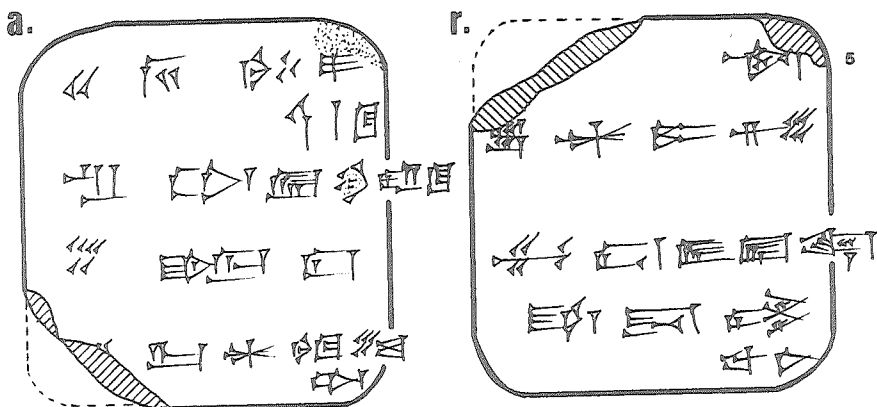

515 (MM 710b)

Umma
AS7/xii/-

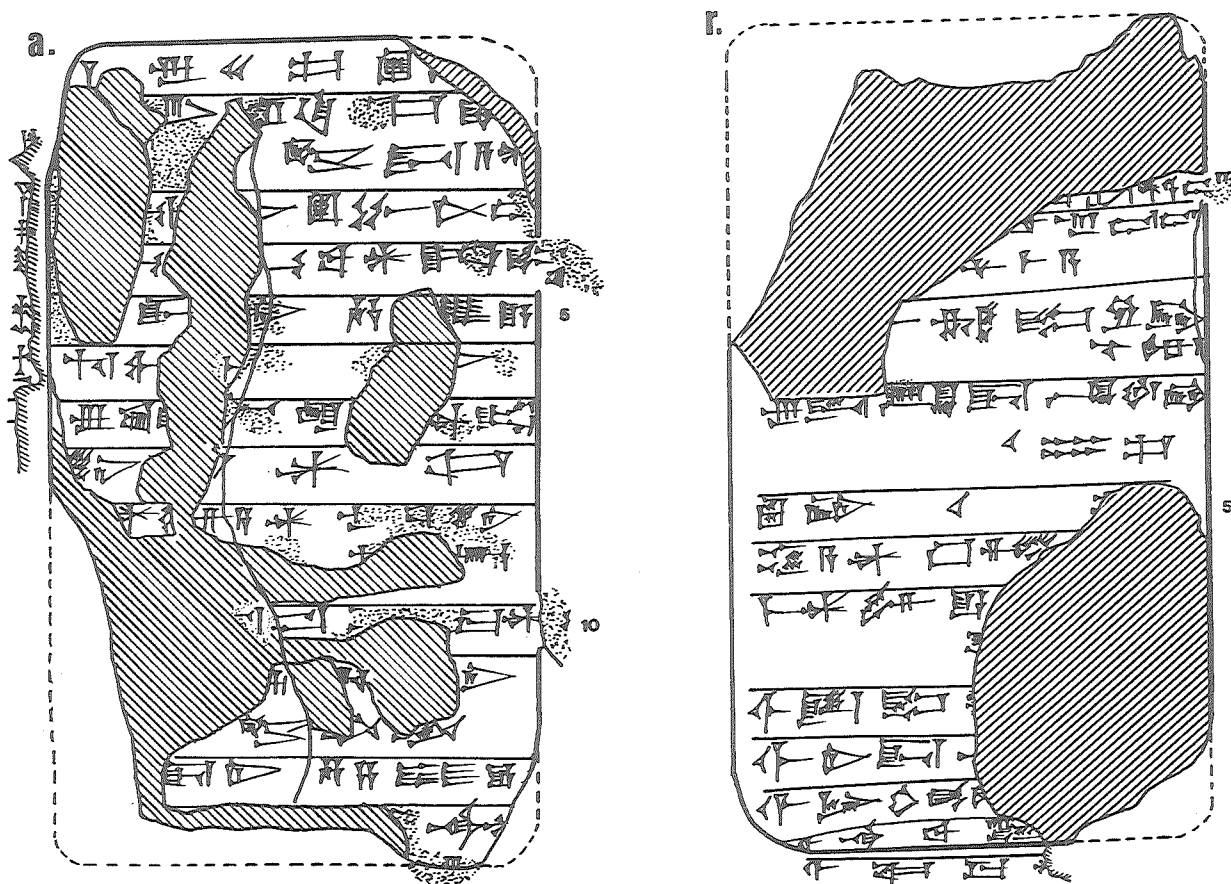

516 (MM 711a)

Umma
SS4/-/-

516. Sello:

Ur-^{sig}gigir
dub-sar
dumu [Bar-r]a-an

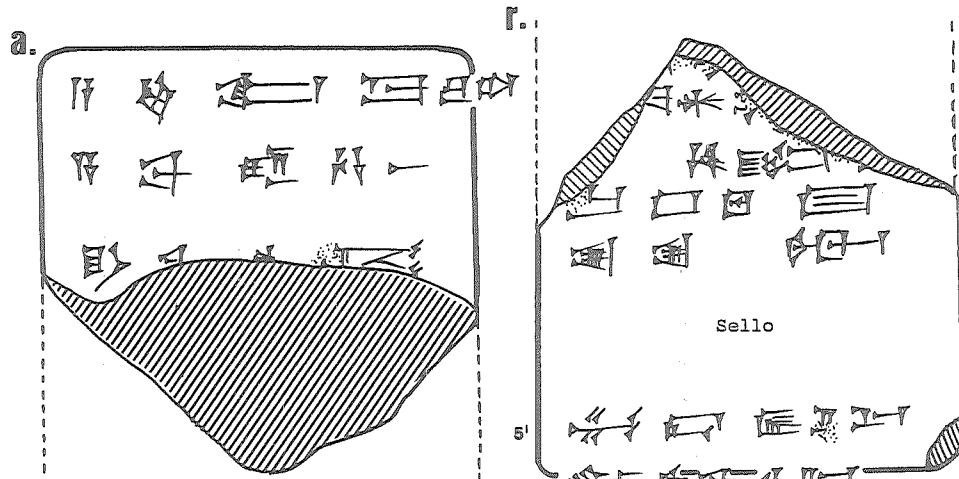

517 (MM 711b)

Umma
AS3/-/-

517. Sello:

Lugal-e₂-mah-e
dub-sar
dumu Lugal-ku₃-ga-ni

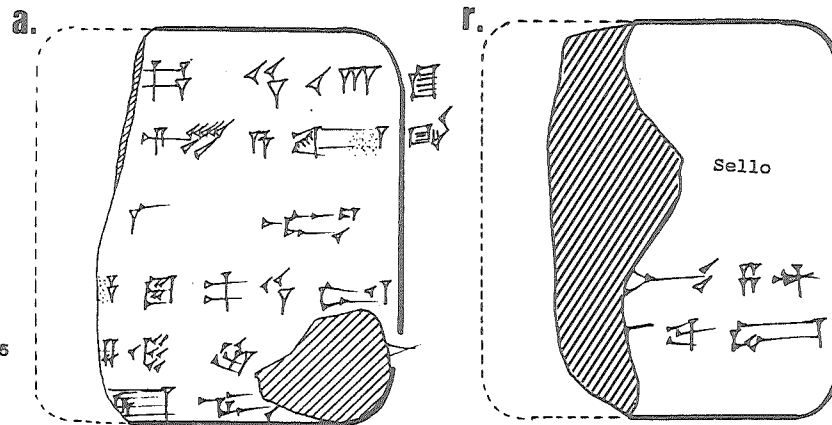

518 (MM 712+731b)

?
[] Reverso destruido

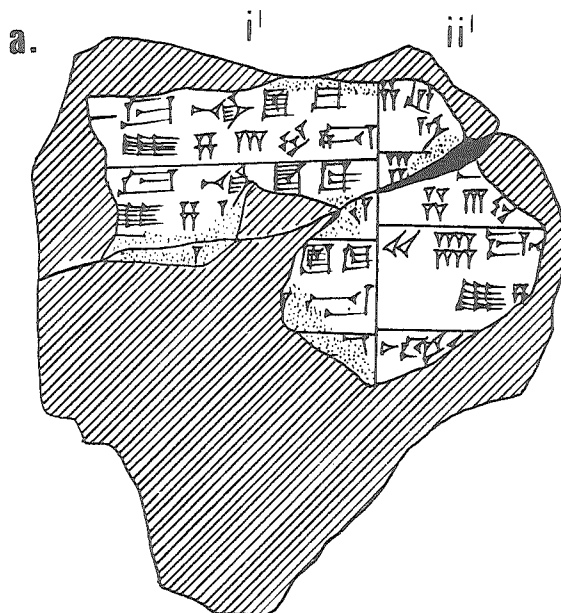

519 (MM 713)

Umma
AS8/xi/17

519. Sello:

[...]
[...]
[arad₂] dSara₂

Anverso destruido

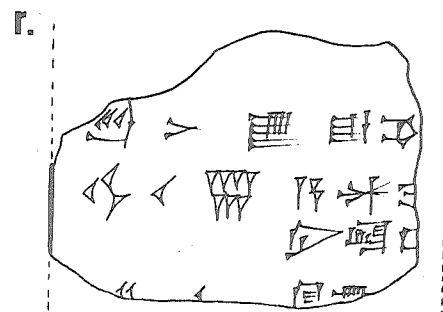

520 (MM 714)

Umma
IS3/-/

Anverso destruido

520. Sello:

- i ^dSu-^dSuen
lugal kal-ga
lugal Uri₅/^{ti}-ma
lugal ^dUb-/da limmu₂-ba
- ii Lu₂-^dSul-/gi-ra
dub-sar
dumu Da-da-ga
arad₂-zu

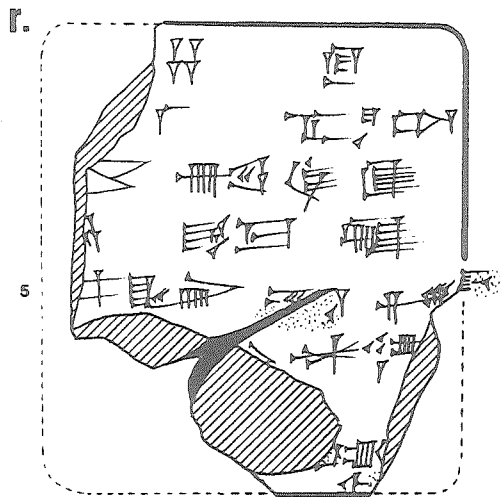

521 (MM 715)

Umma
[]

Reverso destruido

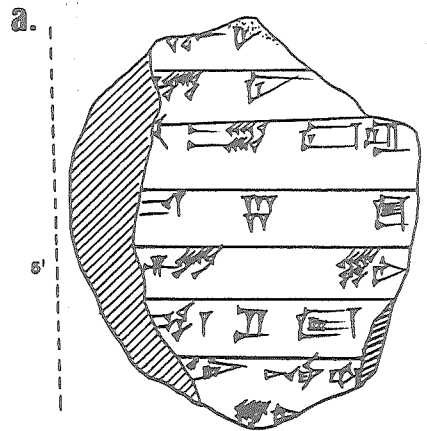

522 (MM 716+910)

Umma
-/-

Rayas de tachadura realizadas
sobre la arcilla aún fresca

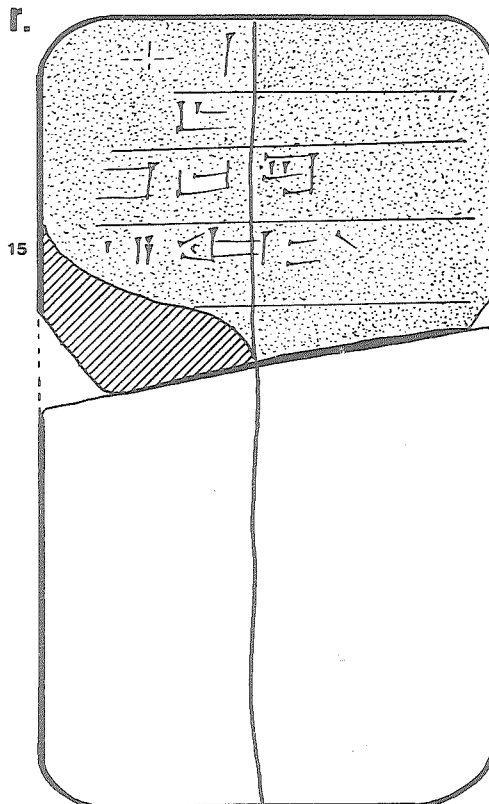
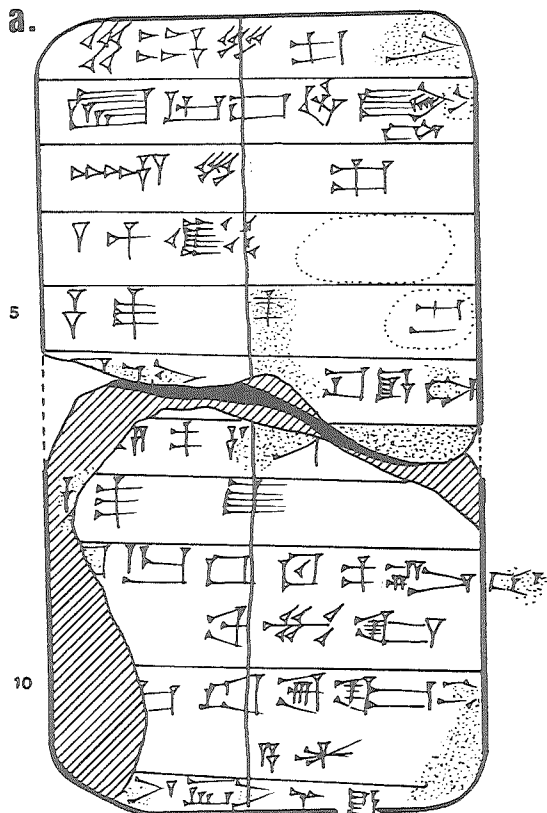

523 (MM 718)

?
ŠS6/[]

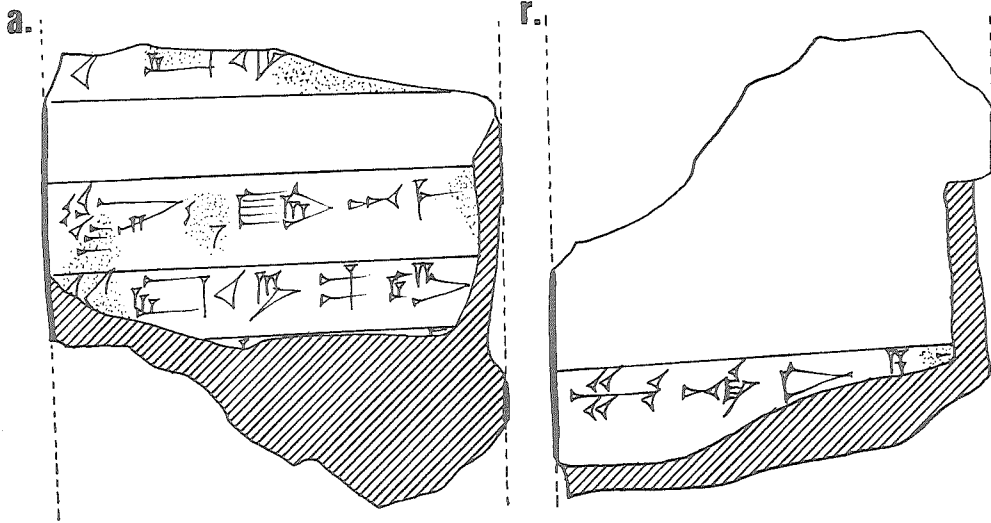

524 (MM 719)

Umma
[]ix/-

526 (MM 721)

?
Š46/[]

526. Sello:

[U]r²-d²[...]
dumu ~Ur²-d²[...]

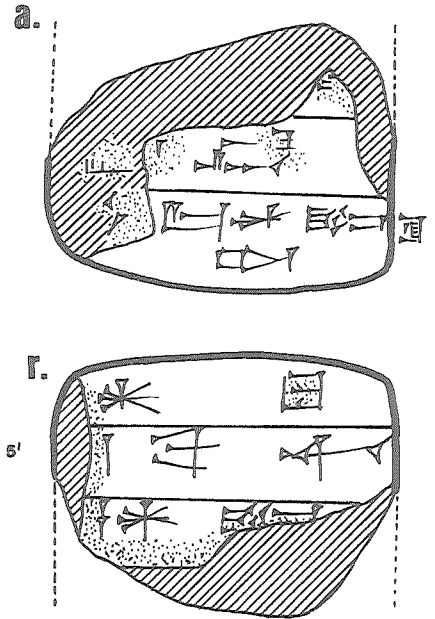
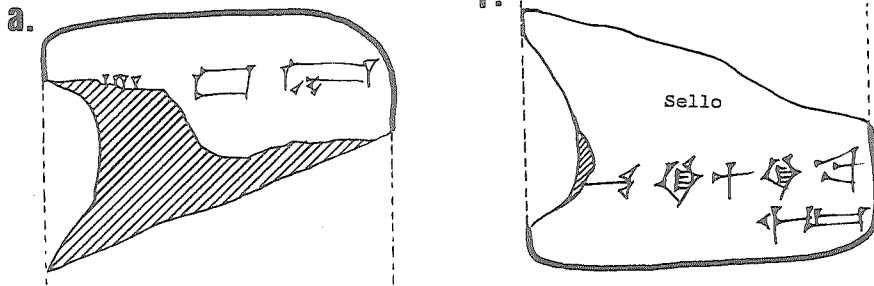

525 (MM 720)

?
[]

Reverso destruido y parte
central anepigráfica

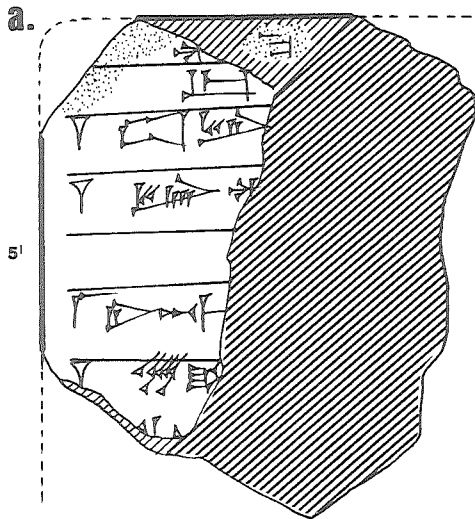

527 (MM 722)

Umma
[]

Reverso destruido

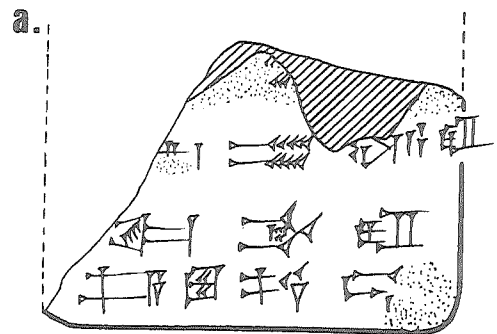

527. Sello ilegible

528 (MM 723)

Umma
-/-

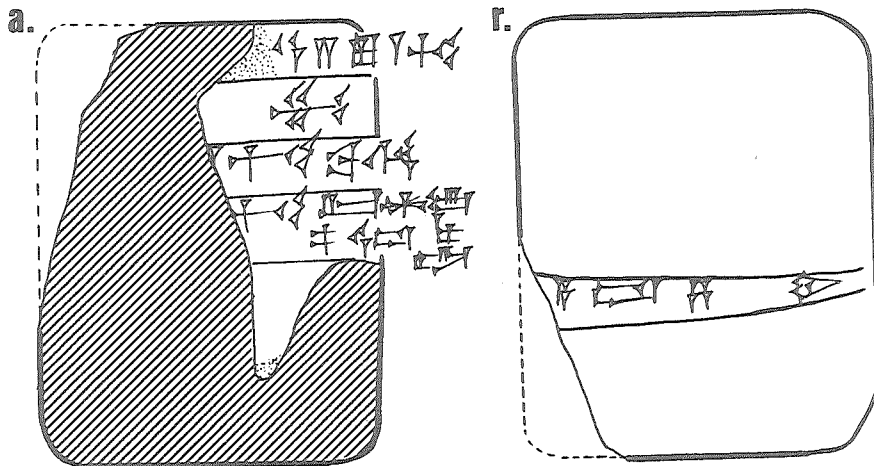

529 (MM 724)

Umma
S46/v/[?]

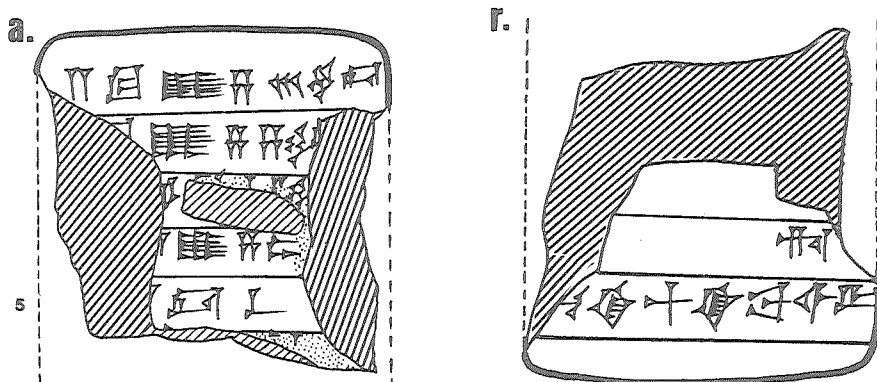

530 (MM 725)

Umma
[]

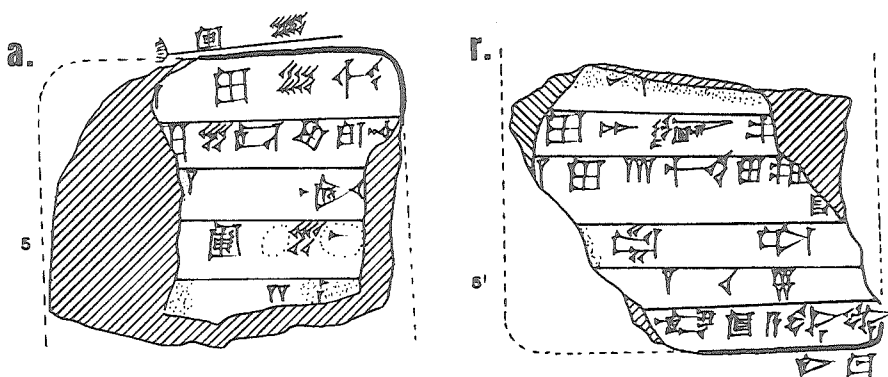

531 (MM 730)

Umma
[]/ii/-

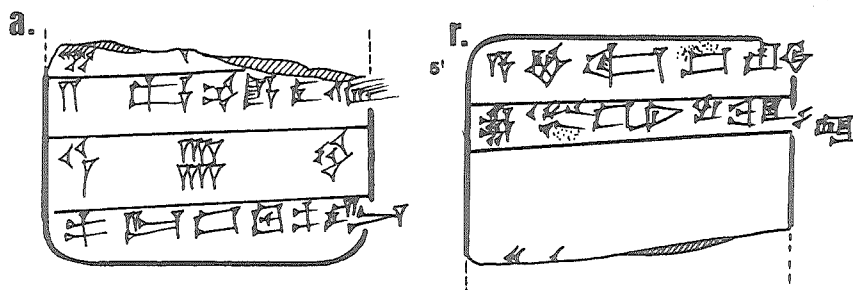

532 (MM 733)

Umma
[]

532. Sello:

Ur-^d[Šara₂]
dub-s[ar]
dumu Š[eš]-kal-[la]

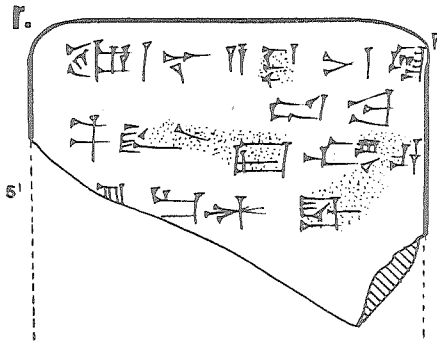
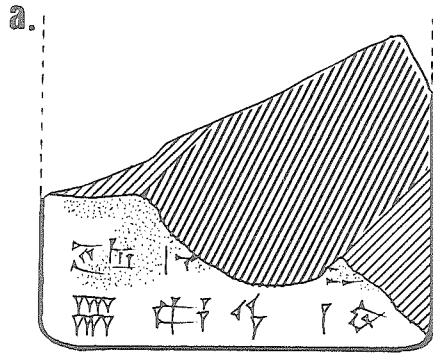

533 (MM 734)

?
AS9/[]

Anverso destruido

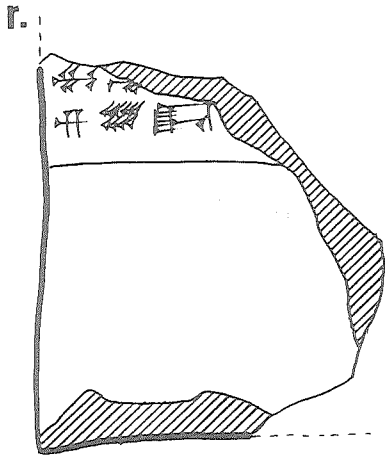

534 (MM 735)

?
[]

Reverso anepigráfico

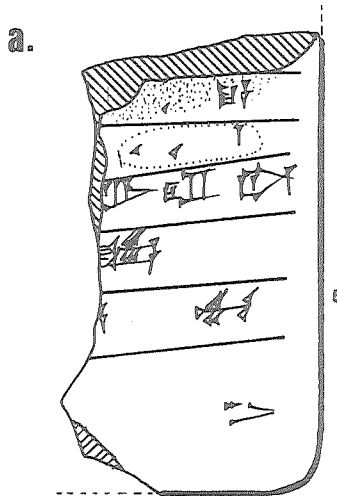

536 (MM 737)

Umma
[]

Reverso destruido

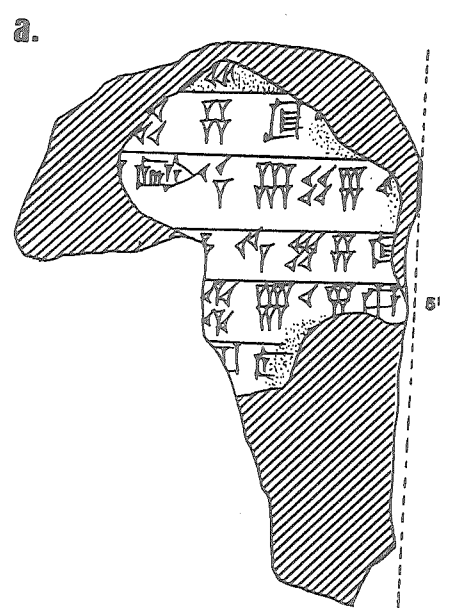

535 (MM 736)

Umma
AS9/viii/-

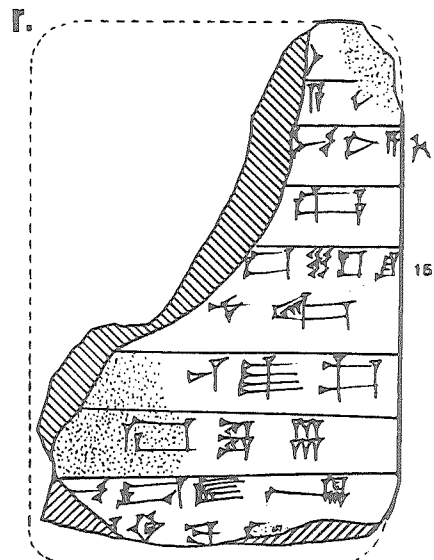
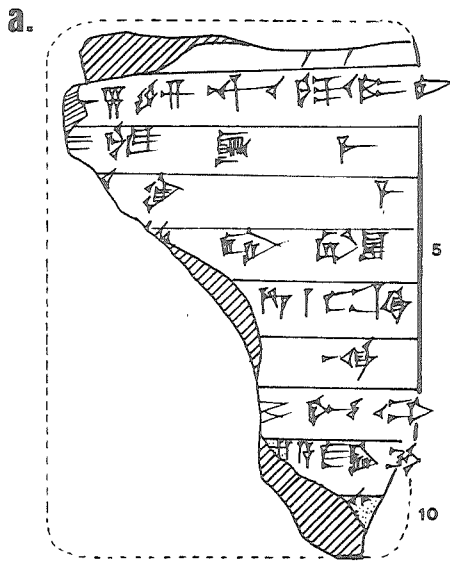

537 (MM 738)

Pl. CCIX

Lagas?
[]

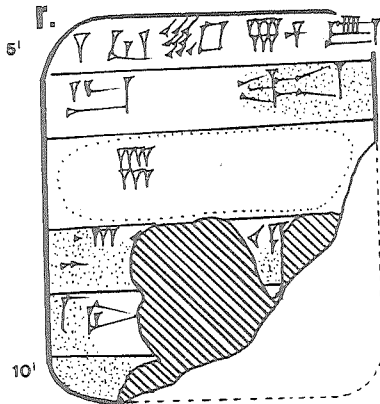
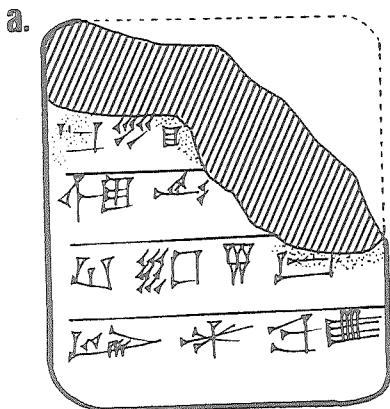

538 (MM 739+1071)

?
[]

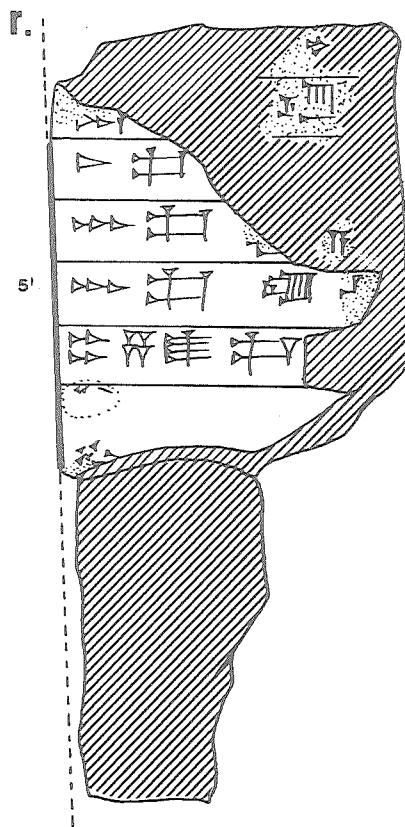
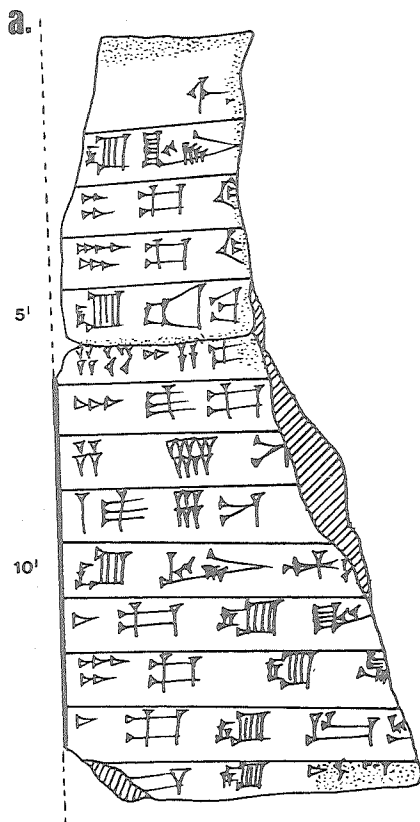

539 (MM 740)

Umma
AS3/-

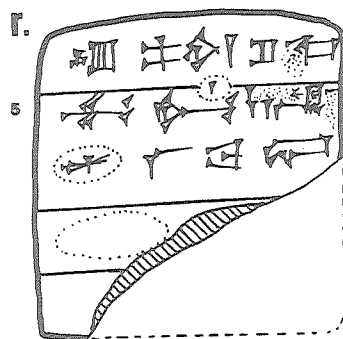
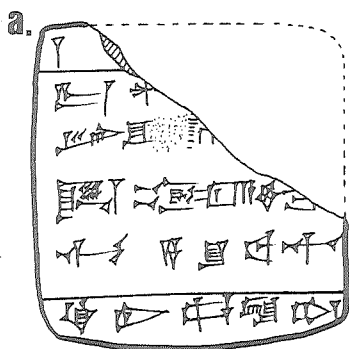

540 (MM 741)

Umma
AS8/[]

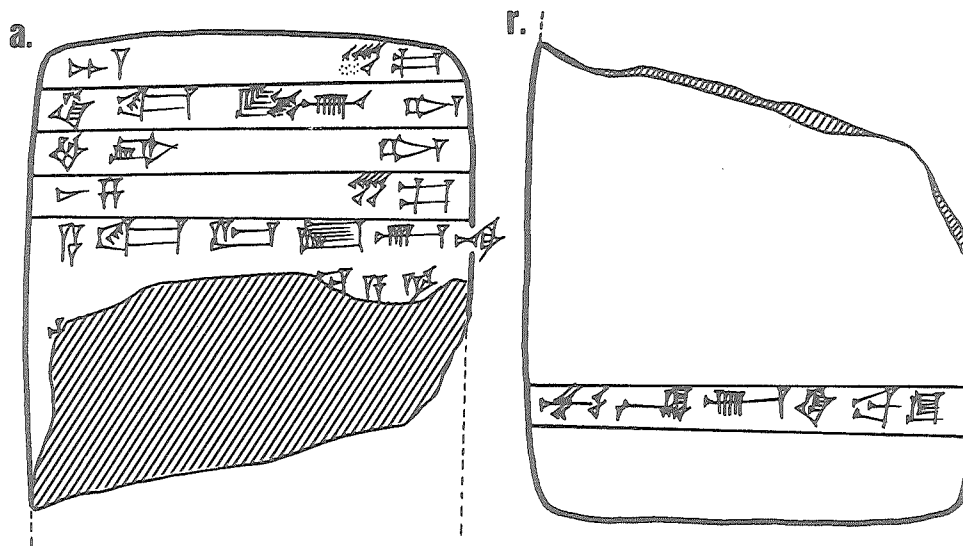

541 (MM 742)

Umma
[]

541. Sello:

Lugal-[...]
([...])
dumu Lugal-[...]

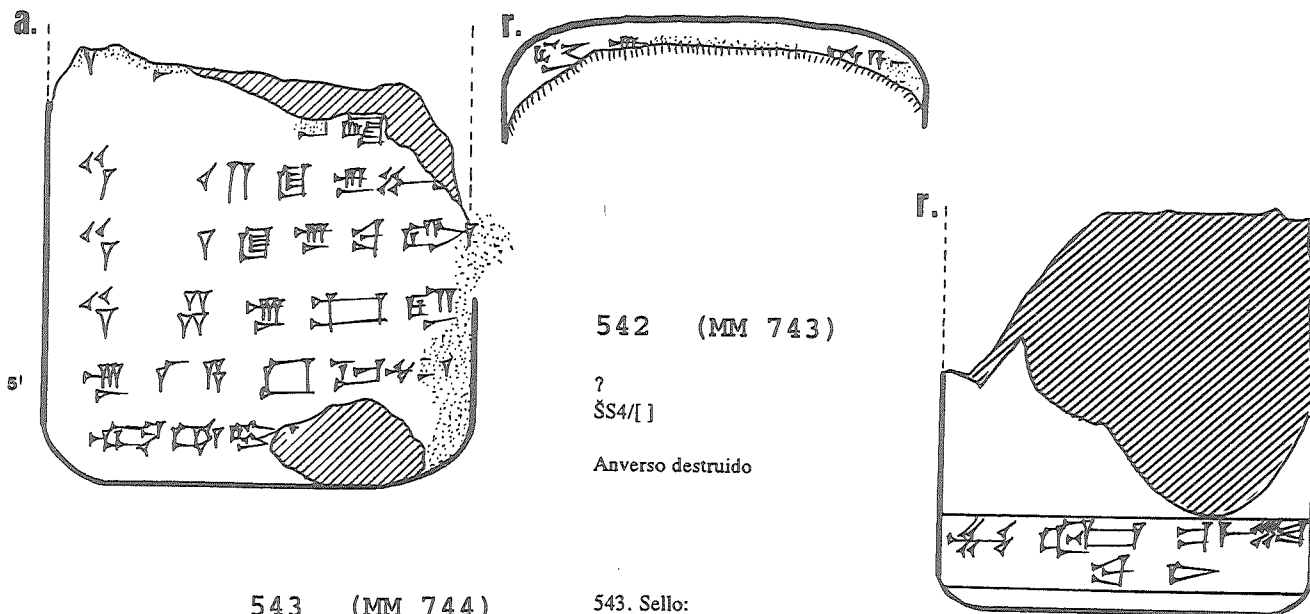

542 (MM 743)

?
ŠS4/[]

Anverso destruido

543 (MM 744)

Umma
[]

543. Sello:

Arad₂-mu
dub-sar
dumu Ur-ni₂-gar kuš,

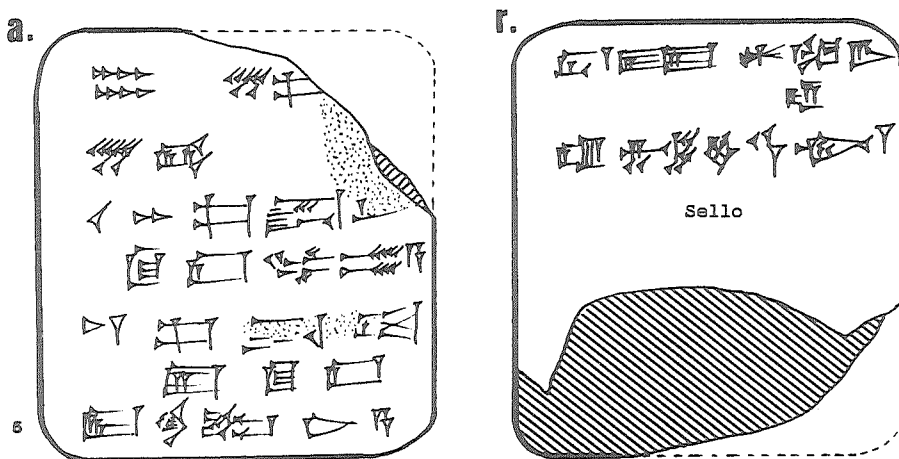

544 (MM 745)

Umma
ŠS1/-/-

544. Sello:

A-gu
dub-sar
dumu Lugal-e₂-mah-e

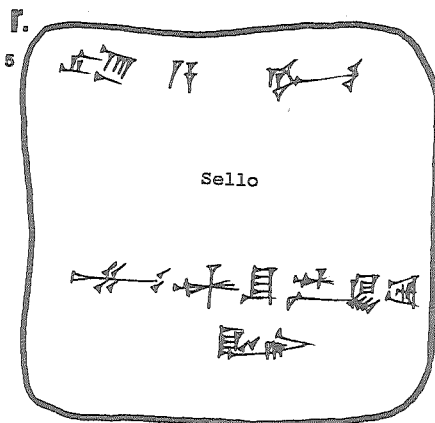
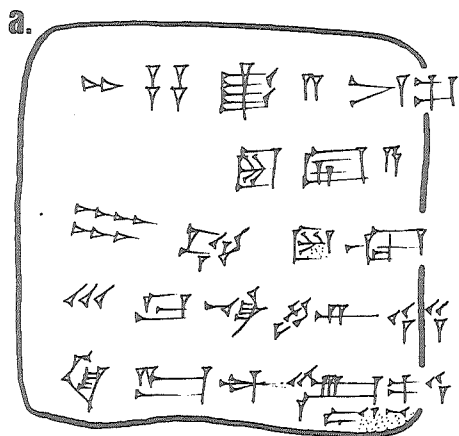

545 (MM 746)

Umma
AS3/viii/- {ix xi 6 xii-viii}

545. Sello:

Ur-^e₁₁-[e]
dub-[sar]
dumu Ur-ⁿⁱ-[gar]

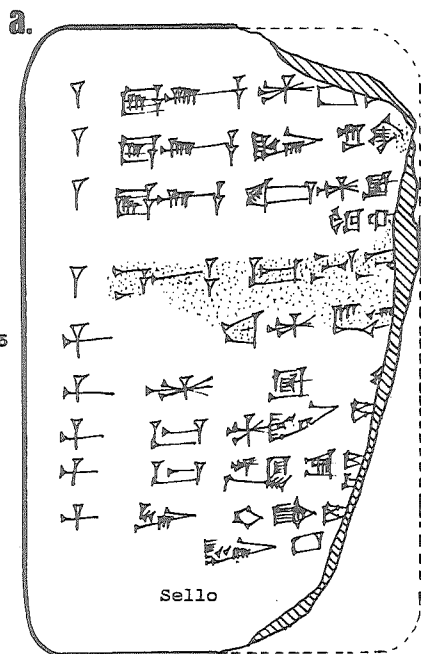

546 (MM 747)

Umma
AS5/iv/[?]

546. Sello:

Da-a-g[i]
dub-sar
Línea en blanco

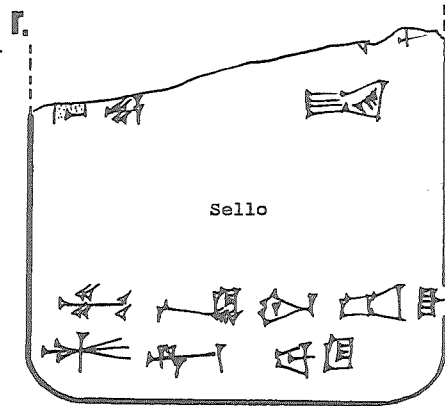
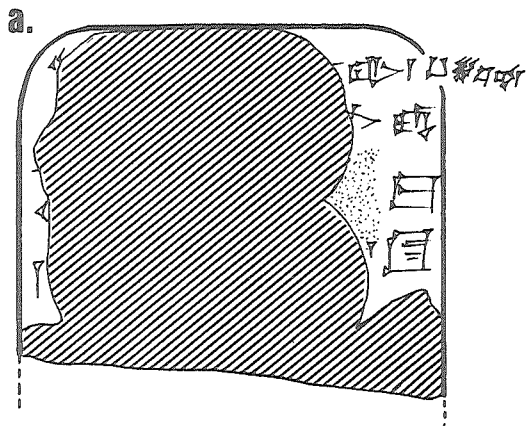

547 (MM 748)

Umma
Š45 6 AS2/-/-

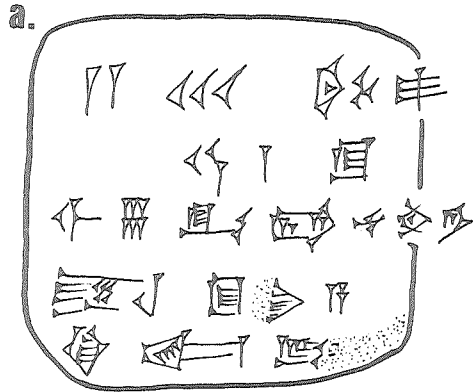

547. Sello:

Lugal-^{su}[gigir-re]
dumu Lu₂-[...]

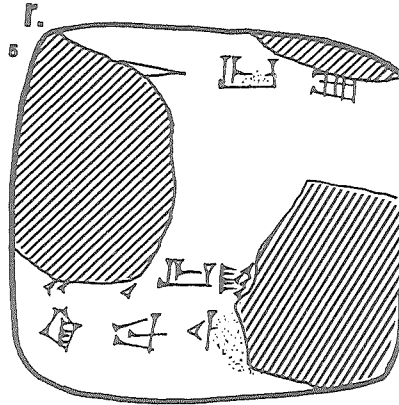

548 (MM 749)

Umma
AS8/iv/-

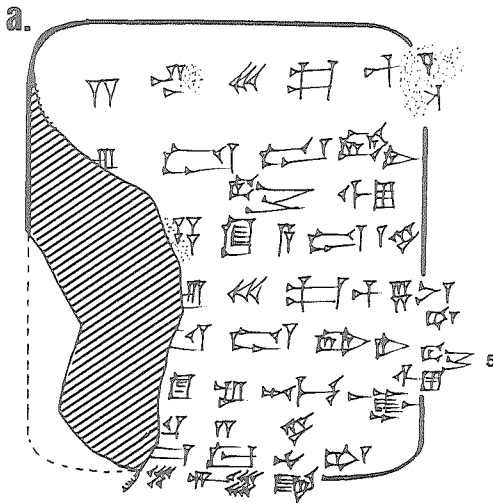

548. Sello:

Ur-[^dNun-gal]
dub-sar
dumu Lugal-e₂-mah-/e

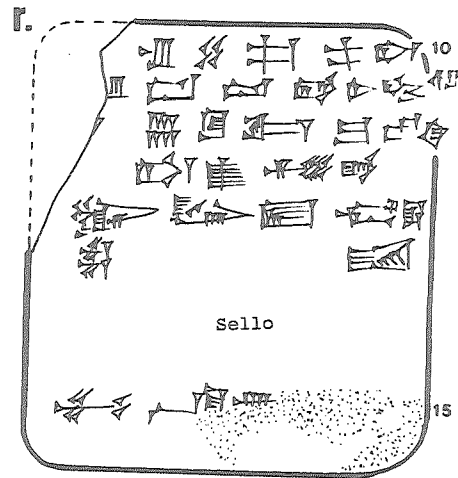

549 (MM 750)

Umma
ŠS2/-/-

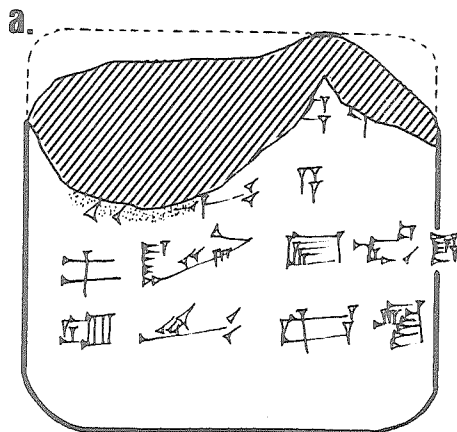

549. Sello:

Šeš^u-kal-[la]
[dub-sar]
dumu Tir-g[u]

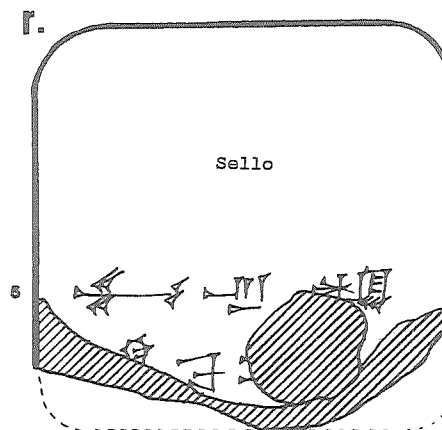

550 (MM 751)

Drehem
[1/1]9

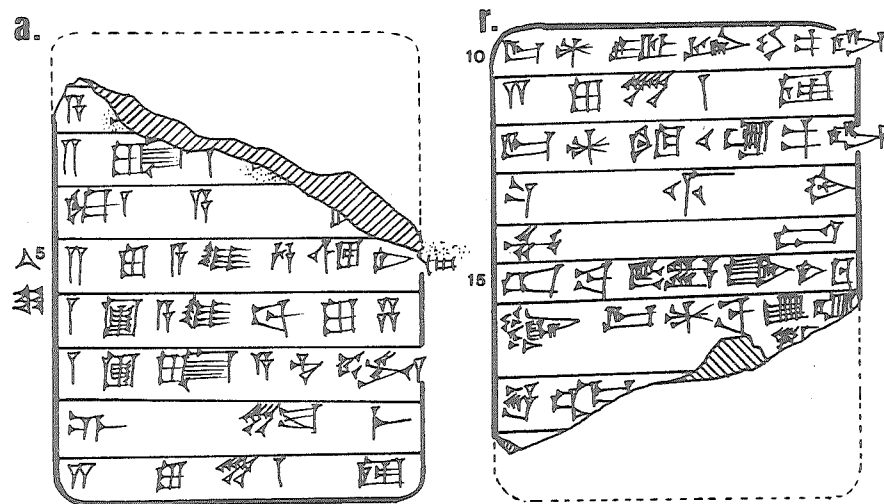

551 (MM 752)

Umma
Š38/vii/-

551. Sello:

[A-ab-ba]
dub-[sar]
dumu [...]

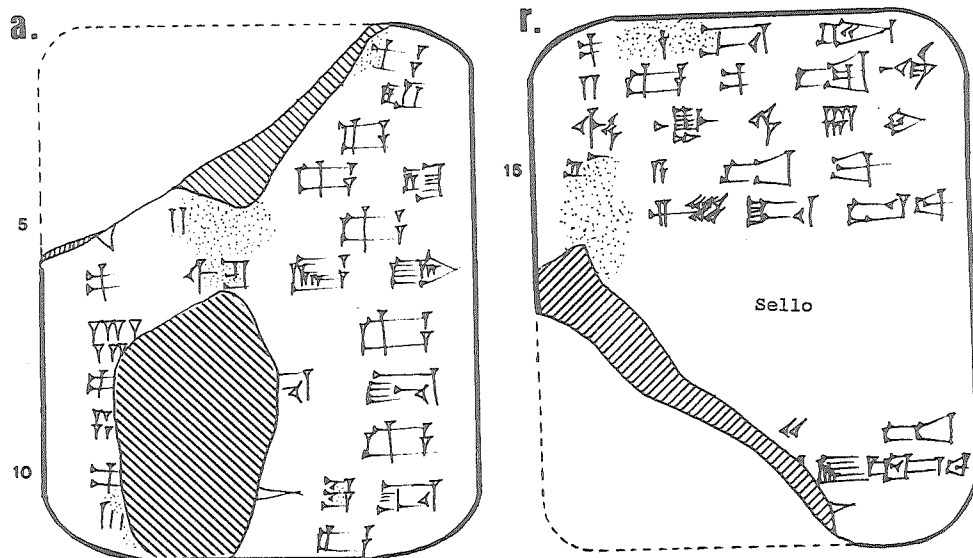

552 (MM 753)

Umma
Š41/-

552. Sello:

[A-t]u d[ub-sar]
du[mu] Lugal-š[a₂-ga]

553 (MM 754)

Umma
AS3/-

Reverso anepigráfico

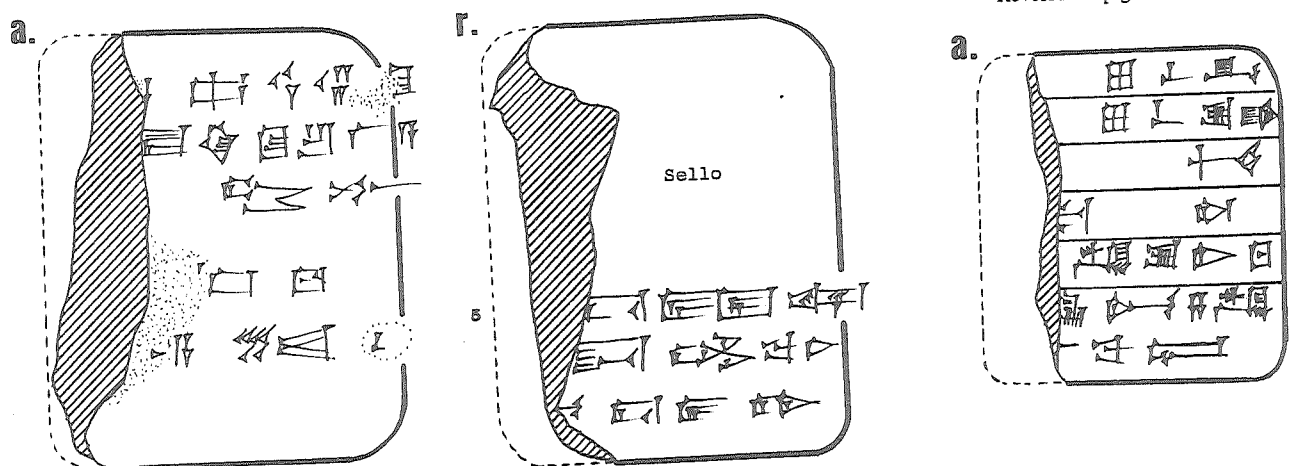

554 (MM 755)

Umma
[]

554. Sello:

Gu-u₂-gu-a
[d]jub-sa[r]
[dumu] Ma-an-[sum]

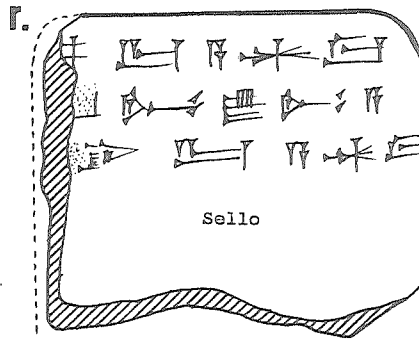
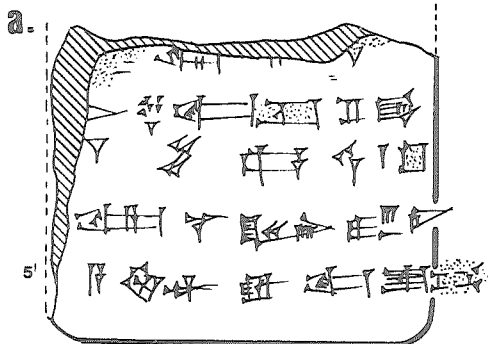

555 (MM 756)

Umma
AS6/-/-

555. Sello:

Lu₂-gi-[na]
dub-^rsar^r
dumu Da-[d]a

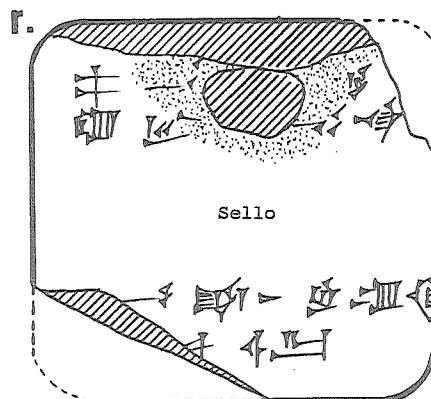
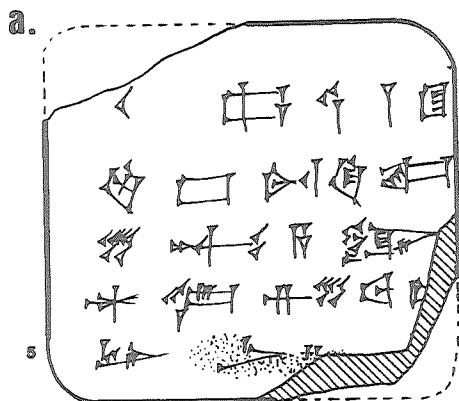

556 (MM 757)

Umma
SS7/-/-

556. Sello:

Lu₂-du₁₀-ga
dub-sar
dumu Ur^a-Nin-/(t)ju

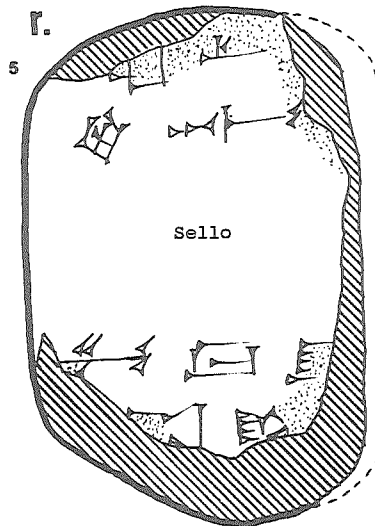
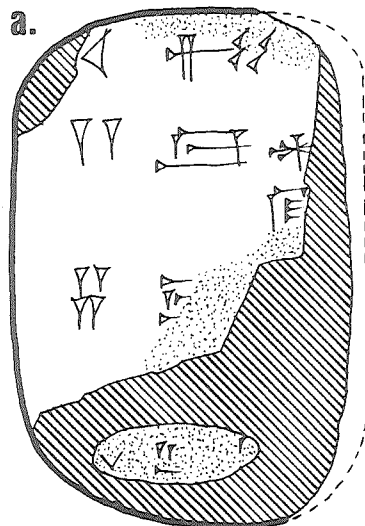

557 (MM 758)

Umma
ŠS5/x/-

557. Sello:

Ur-⁴Nun-gal
dub-sar
dumu Ur-⁴Šara₂
ša₁₃-dub-ba-ka

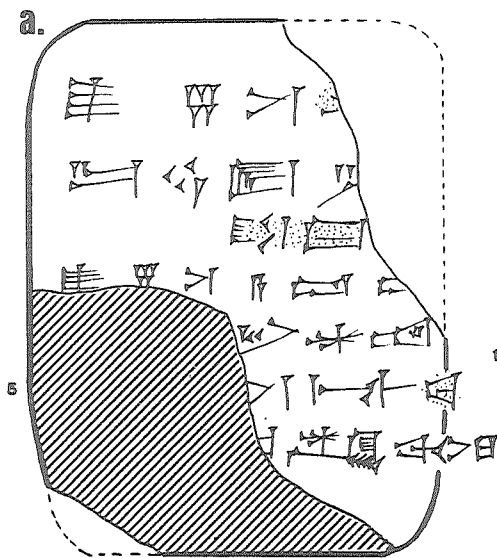

558 (MM 759)

Umma
AS9/-/-

558. Sello:

Lu₂-ša₅-i₃-zu
dub-sar
dumu A-kal-l[a]

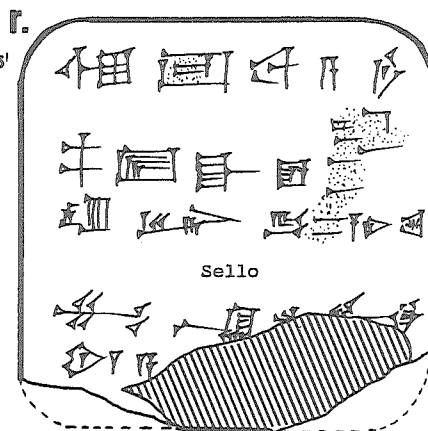
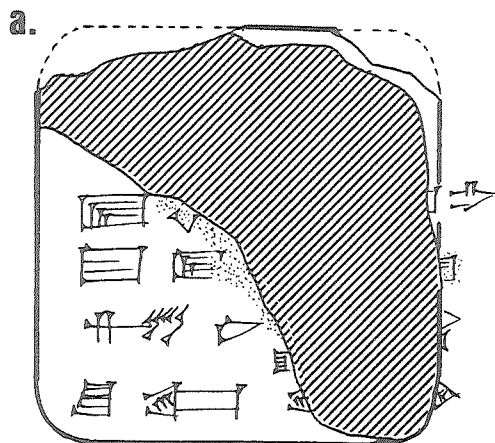

559 (MM 760)

Umma
AS9/-/-

559. Sello:

ʾLugalʾ-e₂-ma[h-e]
[dub]-sar
[dumu] Lugal-ku₃-ga-[ni]

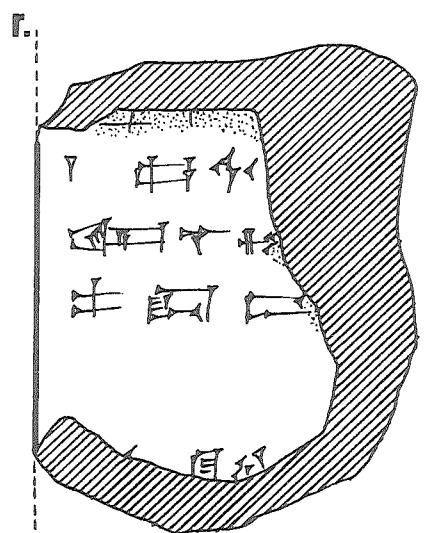
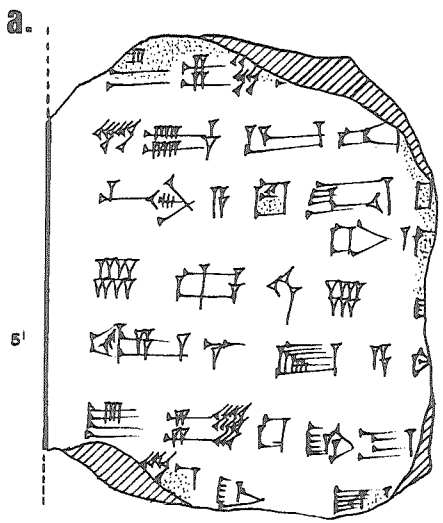

560 (MM 761)

Umma
AS3/iii/-

560. Sello:

Lu₂-^dTUG₂-[AN-ka]
dub-[sar]
dumu Lu₂-^d[Šara₂]
sa₁₂-du₅-ka

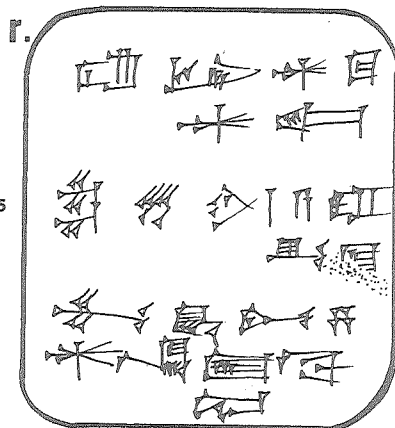
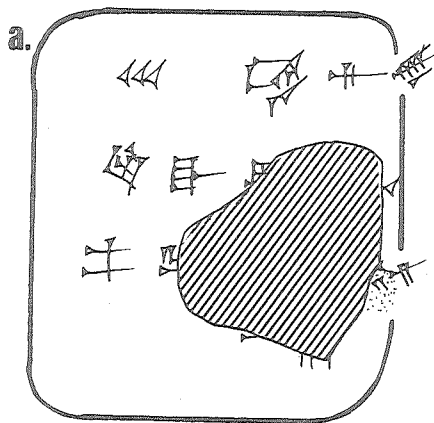

563 (MM 764)

Umma
-/- (AS9/ii)

563. Sello:

Ur-^dŠara₂
dub-sar
dumu Šeš-kal-la

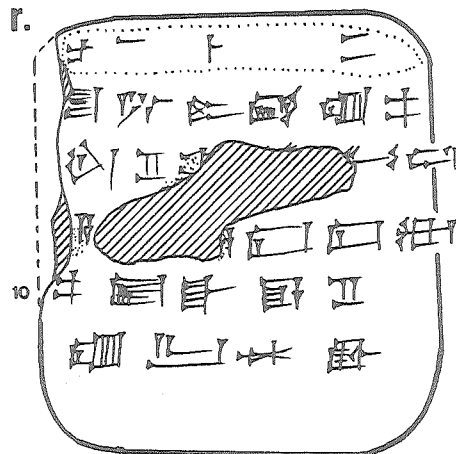
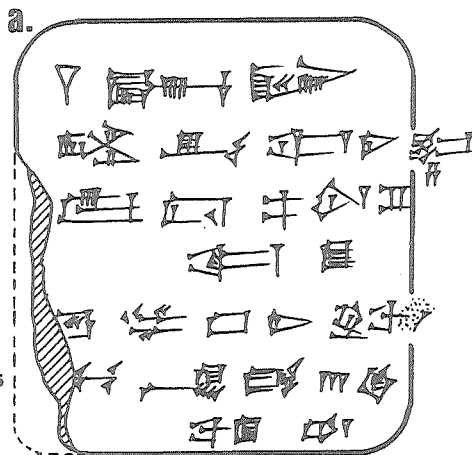

564 (MM 765)

Umma
ŠS8/- (iii-[])

564. Sello:

i ^dSu-^dSuen
lugal kal-ga
lugal Uri₅-^dma
lugal ^dUb-/da limmu₂-ba
ii Gu-du-du
dub-sar
dumu Da-da-ga
arad₂-zu

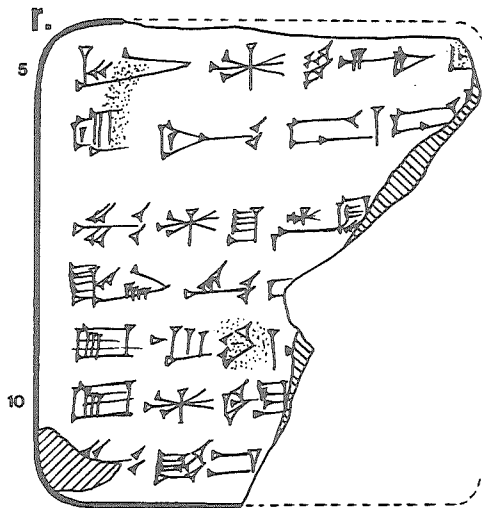
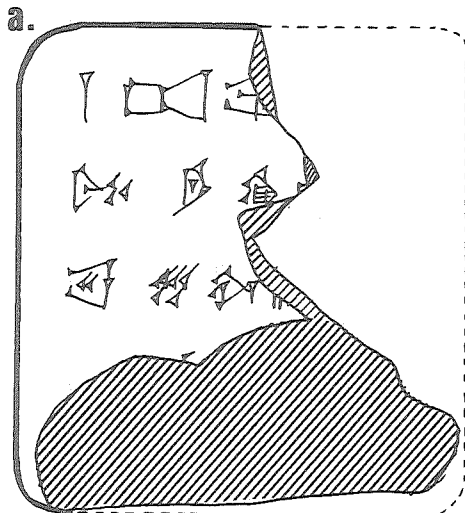

562 (MM 763)

Umma
[]/-/

562. Sello:

([...]) "dumu" Lugal-[...]

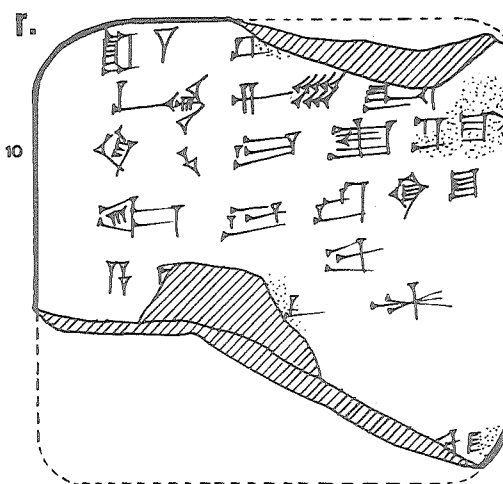
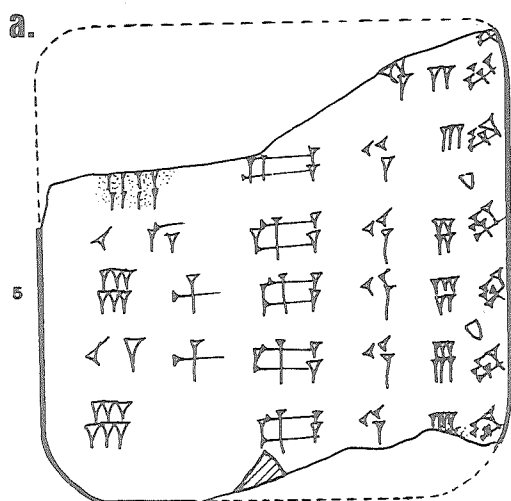

561 (MM 762)

Umma
Š45/ii 6 iii/-

Reverso anepigráfico con borradura
(visible lugal KA) y sellado

565 (MM 766)

Umma
AS3/v/-

565. Sello:

"Da"-a-[gi]
dub-[sar]
Línea en blanco

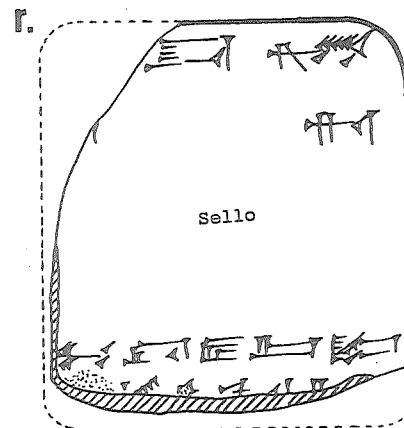
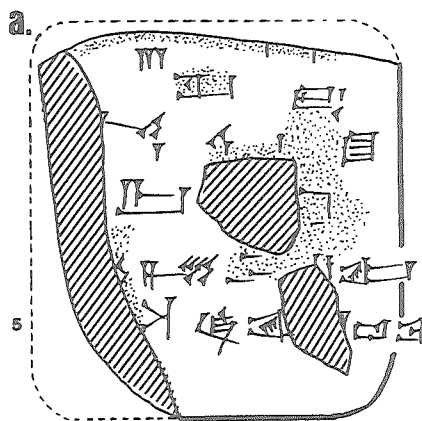
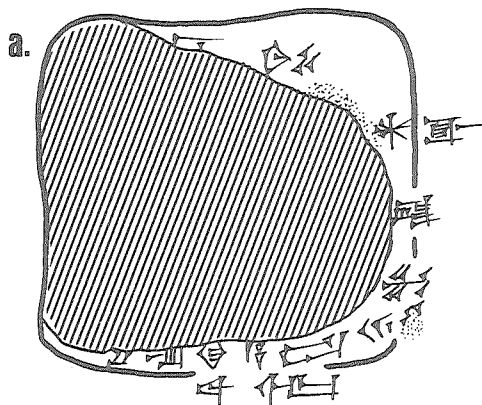

561. Sello ilegible

566 (MM 767)

Umma
ŠS2/-/

566. Sello:

Lugal-ba-ta-[a]b²-e₃²
dumu "I"-ti-[...]

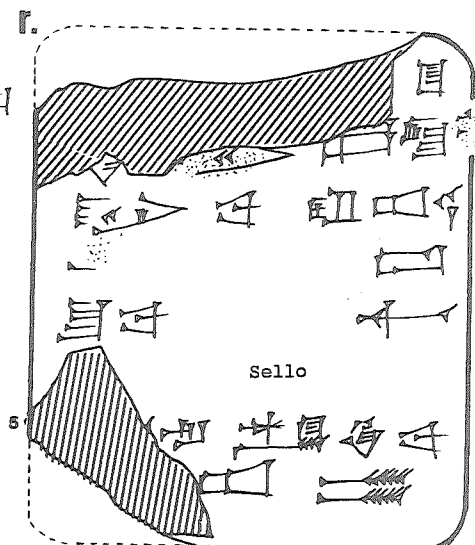
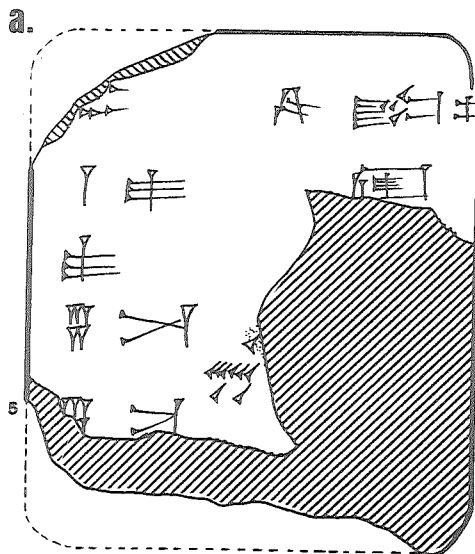

567 (MM 768)

Umma
ŠS3/v/-

567. Sello:

Lugal-⁴[Ištaran]
dub-⁷sar⁷
dumu ⁷Lu₂-⁷[ban₃-da]

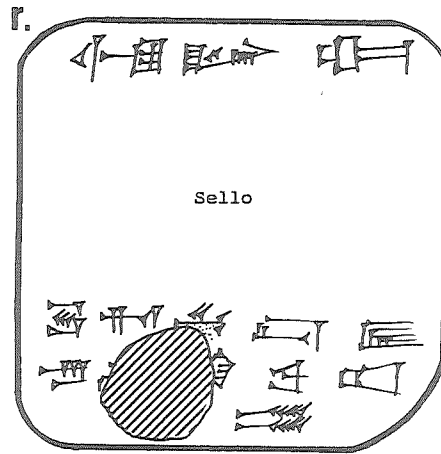
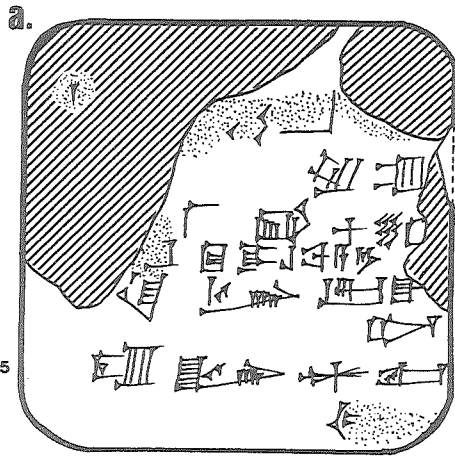

568 (MM 769)

Umma
ŠS9/xi/-

568. Sello:

A-⁷lu₅-⁷[lu₅]
dumu Inim-⁴Šara₂
kurušda ⁴Šara₂-[ka]

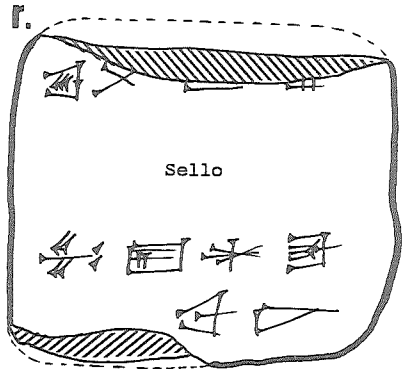
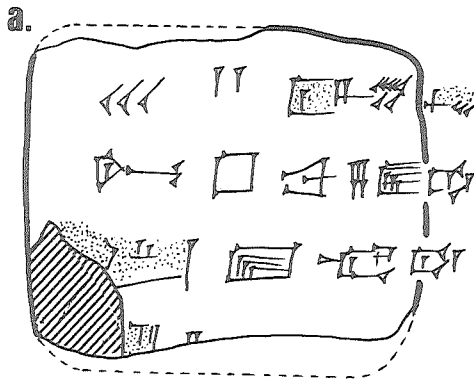

569 (MM 770)

Umma
ŠS7/[]

569. Sello:

A-du
dub-sar
dumu Lu₂-ga

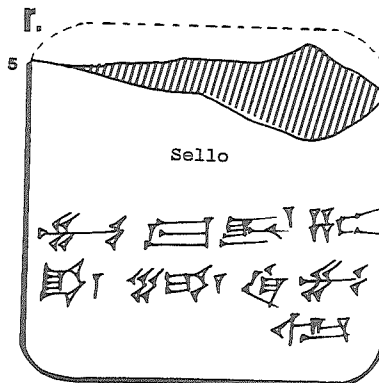
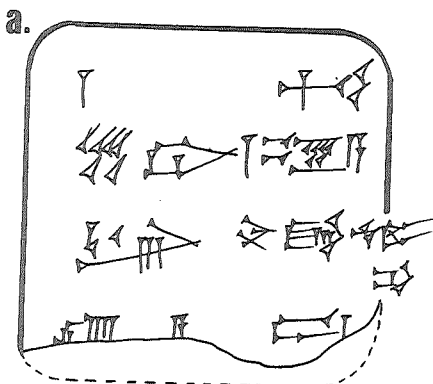

570 (MM 771)

Umma
AS4/-/

570. Sello:

Lugal-si-NE-[e]
dub-[sar]
dumu Lugal-ša₂-g[a]

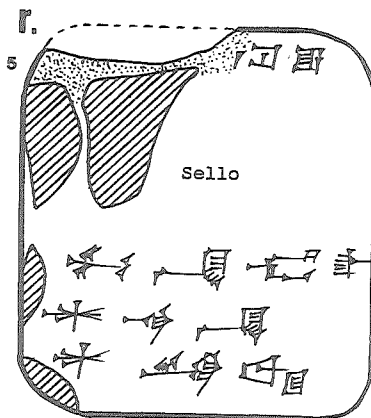
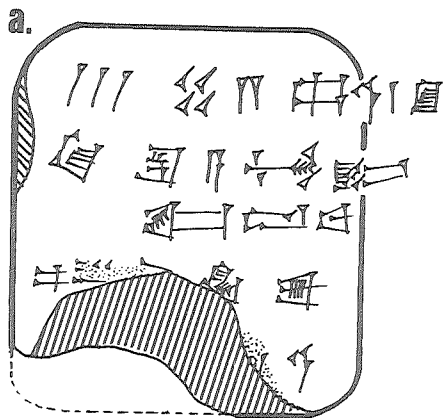

571 (MM 772)

Umma
ŠS2/-/

571. Sello:

A-kal-la
dumu Lu₂-bulug₃-ga₂
ašgab gal

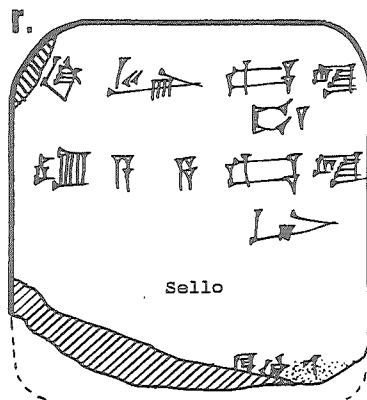
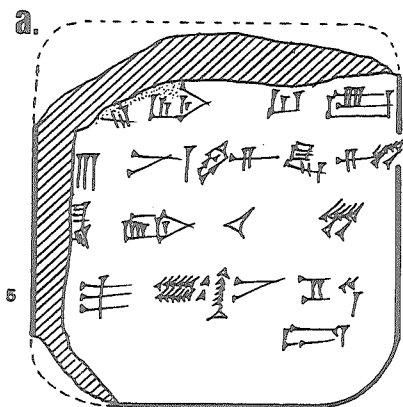

572 (MM 773)

Umma
-/-

572. Sello:

Šara₂-kam
dub-[sar]
dumu Da-da

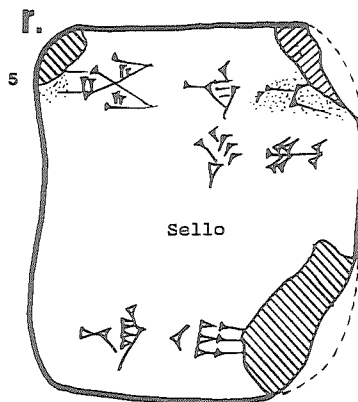
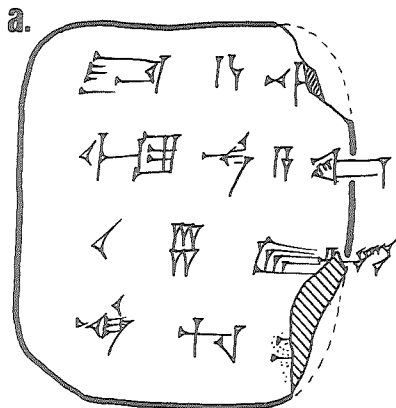

573 (MM 774)

Umma
AS7/vi/-

573. Sello:

Igi-Šara₂-[še₃]
arad Ša[ra₂]

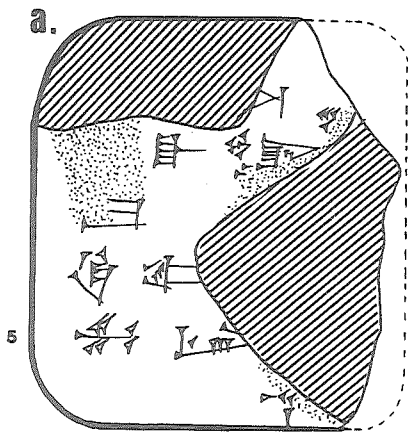

574 (MM 775)

Umma
ŠS3/vi/5

574. Sello:

I₂-[kal-la]
du[b-sar]
du[mu L]u₂-š[a₆-ga]

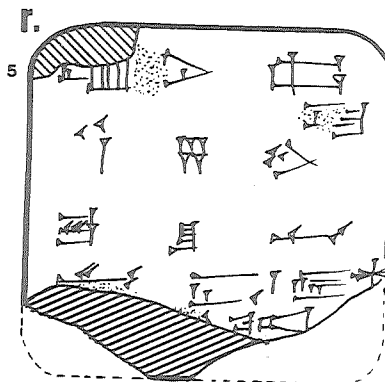
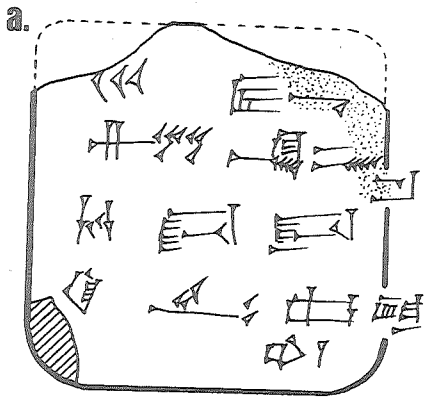

575 (MM 776)

Umma
Š47 48 6 AS1/[]

575. Sello:

Lu₂-du₁₀-ga
dub-sar
dumu Ur-ni₉-[gar]

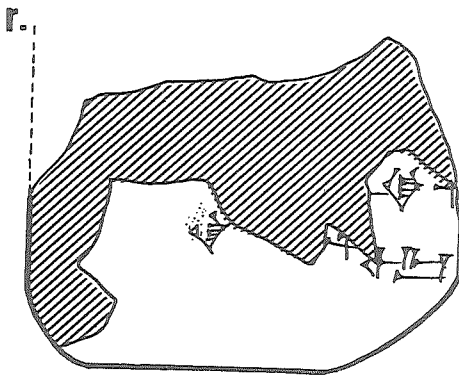
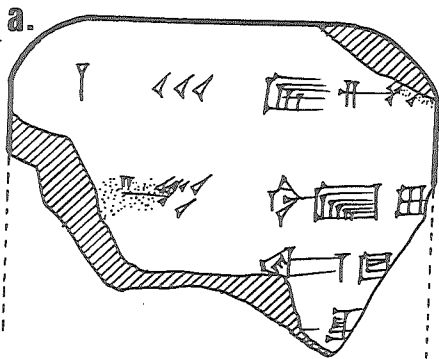

576 (MM 777)

Umma
[]

576. Sello:

Lu₂-dingir-ra
dub-sar
dumu A₂.AN.DU.RU

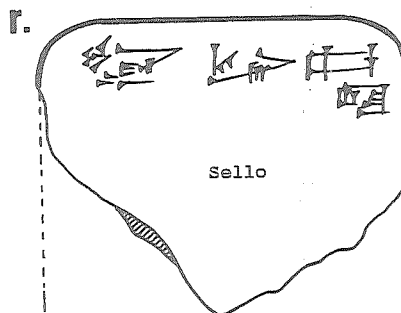
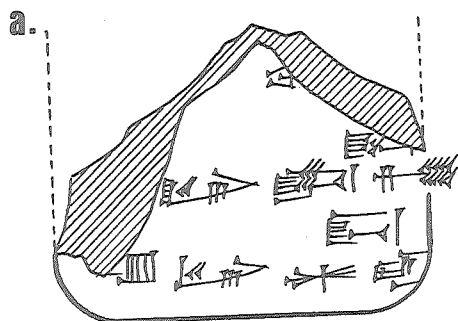

579 (MM 780)

Umma
[]

579. Sello:

¹⁰³Sara₂-i₃-z[u]
dub-sa[r]
dumu Arad₂ ka-g[ur,]

577 (MM 778)

Umma
SS1/[]

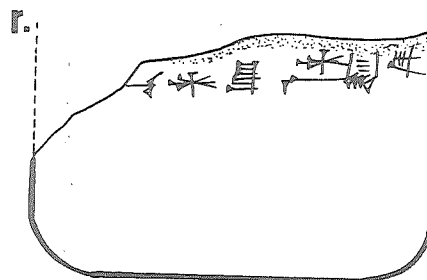
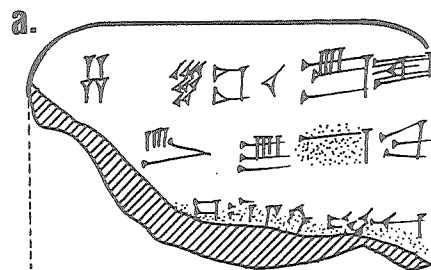
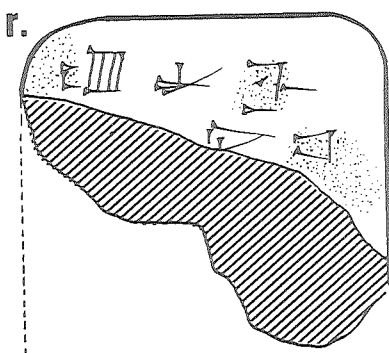
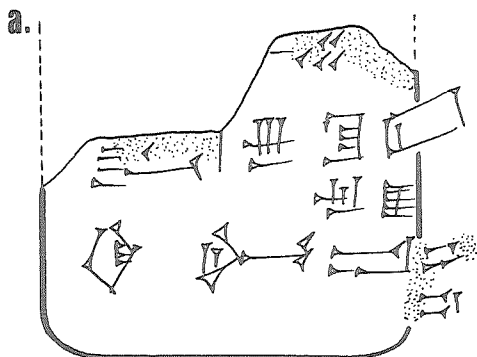

578 (MM 779+788)

Umma
Š46/-/-

578. Sello:

Lu₂-dingir-ra
dub-sar
dumu A₂.AN.DU.RU

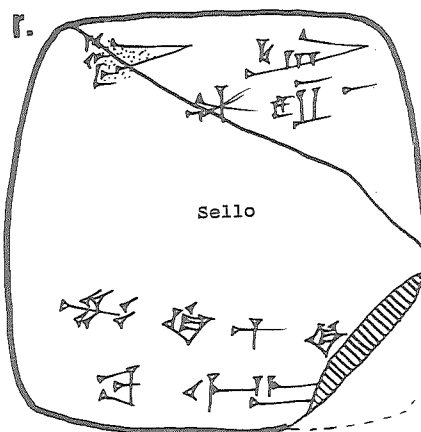
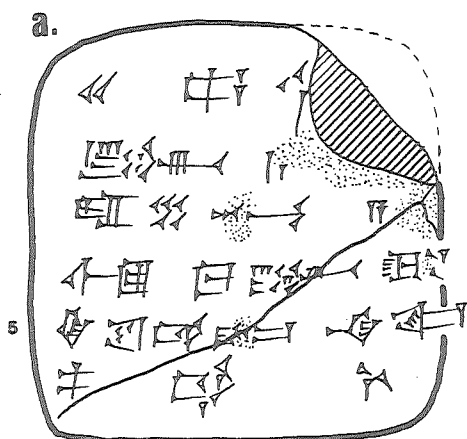

577. Sello:

A[b]-ba-[...]
dumu [...]

580 (MM 781)

Umma
[]

Tablilla demasiado destruida para copia

580. Sello:

[Ba]-ša₆
[dub]-sar
[dumu] Lugal-ša₆-ga

581 (MM 782)

Umma
AS2/-

Reverso anepigráfico

581. Sello:

[Lu]gal-^a₂-[zi-da]
[dub-sar]
[dumu Da]-d[a]

582 (MM 783)

Umma
[]/-

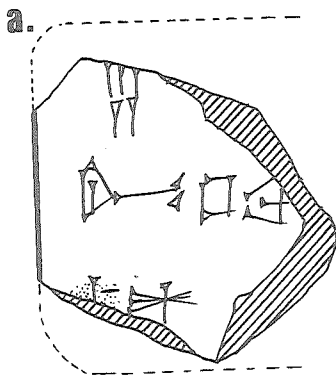

582. Sello:

Ša[ra₂-kam]
dub-s[ar]
dumu Lugal-^{ki}kiri₆

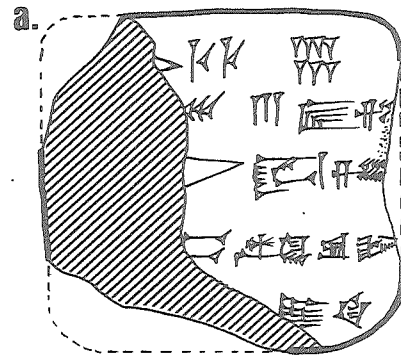
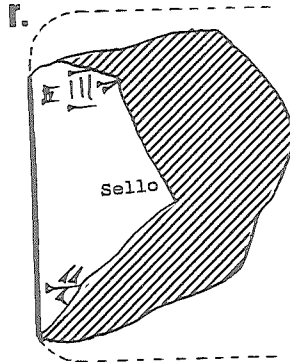

585 (MM 786)

Umma
ŠS6/-

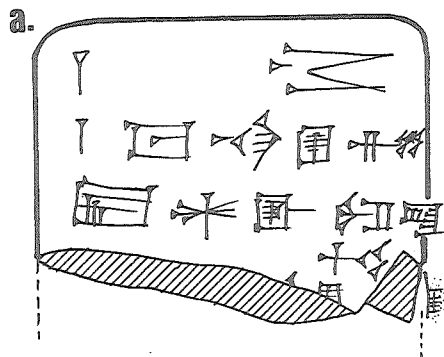

585. Sello:

Lugal-ku₃-zu
dub-sar
dumu Ur-ni,-gar kuš,

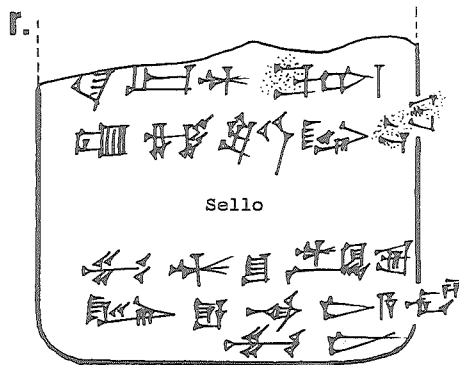

583 (MM 784)

?
[]

Anverso destruido

583. Sello:

[...]
dub-sar
dumu A-ka[l-la]

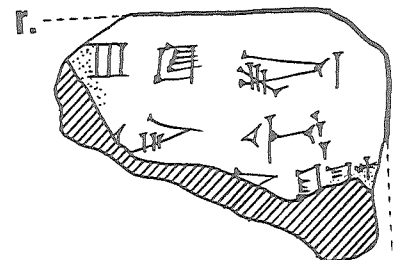

584 (MM 785)

Umma
[]

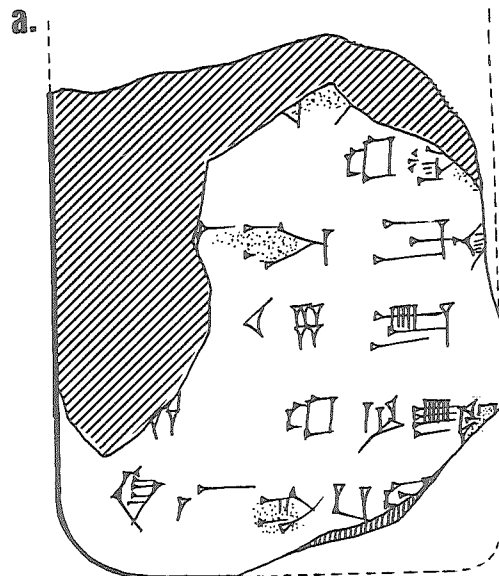

584. Sello:

Ur-Šara₂
dub-sar
dumu Lugal-[nanga]

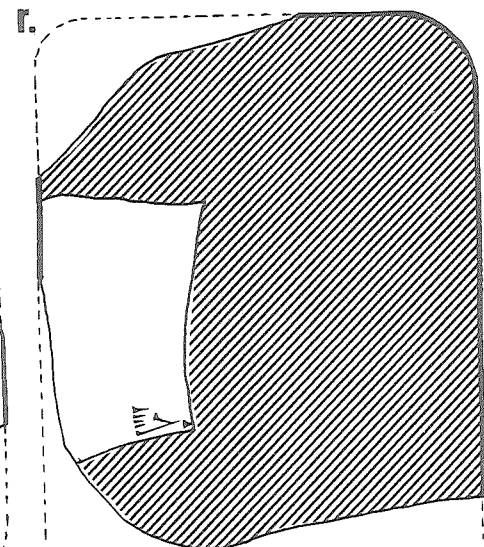

586 (MM 787)

Umma
[]

Reverso destruido

586. Sello:

Nin₂-hi₂-[li₂-a]
dam A-a-kal-la
dumu Ur-^dDa-mu

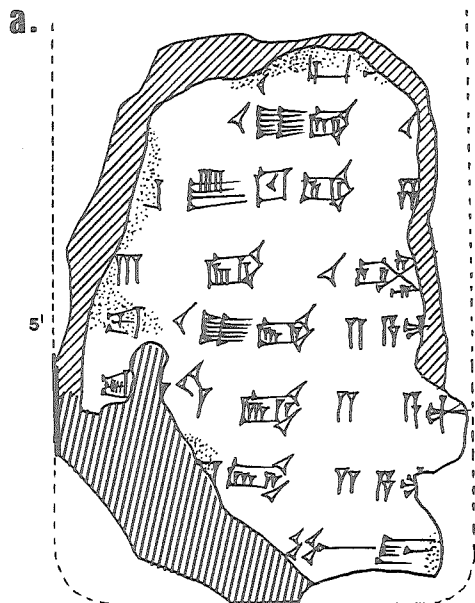

587 (MM 789)

Umma
[]/-/ (iv-[])

587. Sello:

Lu₂-kal-la
dub-sar
dumu Ur-e₁₁-e [kuš₂]

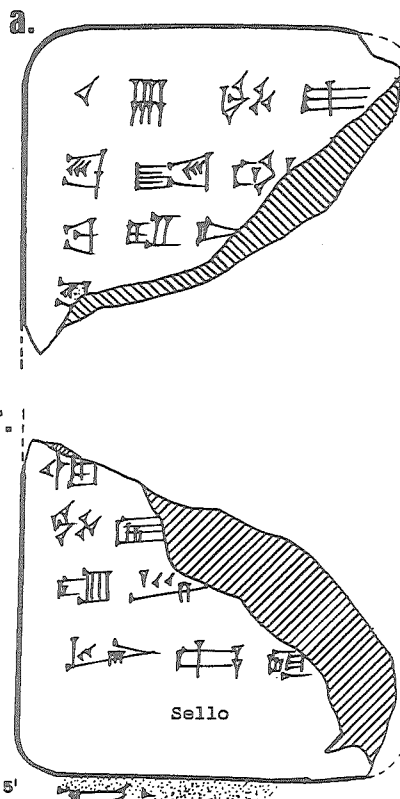

588 (MM 790)

Umma
AS9/-/

588. Sello:

Nu-ur₂-^d[Adad]
dub-[sar]
dumu 'A-hu-táb'

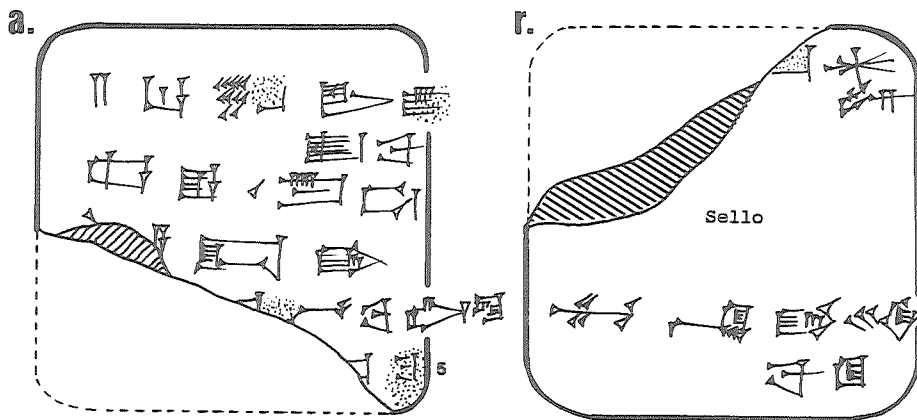

589 (MM 791)

Umma
ŠS1/vii/-

589. Sello:

[U]r-ab-zu
[dumu] 'Lugal'-[nanga]
[nu]-'banda, gu₄' [^dSara₂]

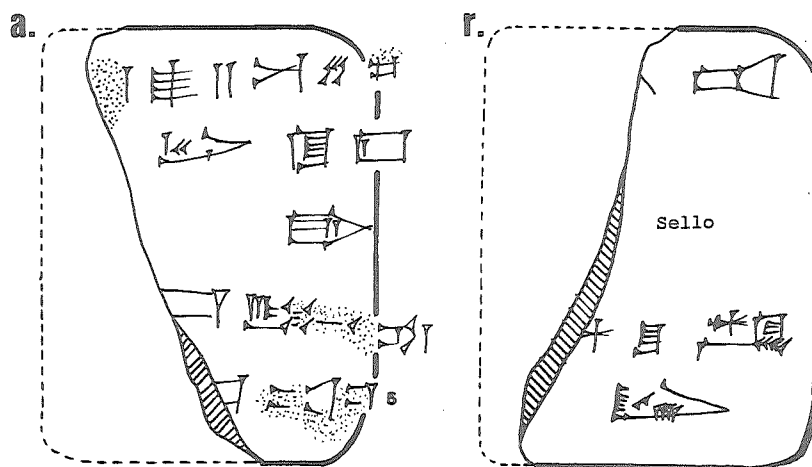

590 (MM 792)

Umma
ŠS2/-/-

590. Sello:

Lugal-e-ba-an-[ša₆]
dub-[sar]
dumu Ur-⁴[Ištaran]

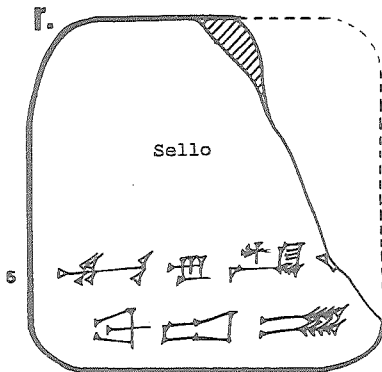
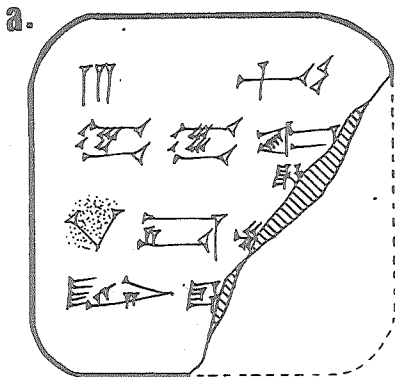

592 (MM 794)

Umma
[]

Reverso destruido



591 (MM 793)

Umma
ŠS5 6 61/-

591. Sello:

Lugal-ku₂-[zu]
dumu Lugal-nig₂-lagar-e

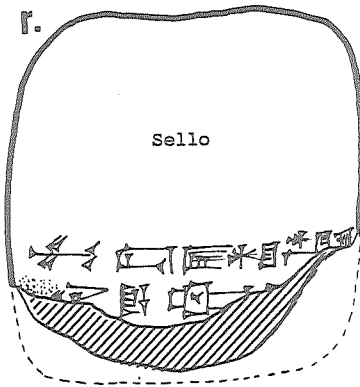
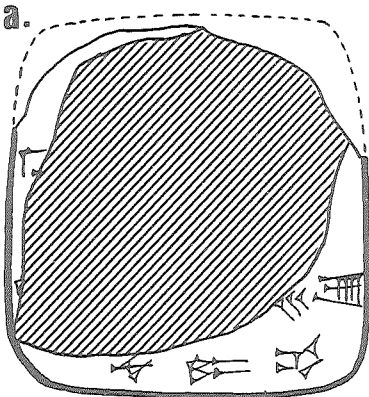

592. Sello:

- i [ʽI-bi₂-/ʽSuen]
[lugal kal]-ga
[lugal Ur]i₂/[¹⁰]-ma
- ii G[u-du-du]
dub-[sar]
dumu D[a-da-ga]
en[si₂]
Umma^[10]
arad₂-zu

593 (MM 795)

593. Sello ilegible

Umma
Š35/[]

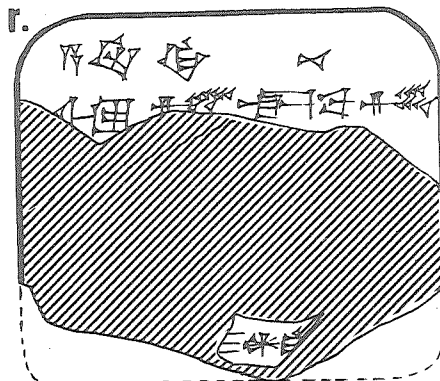
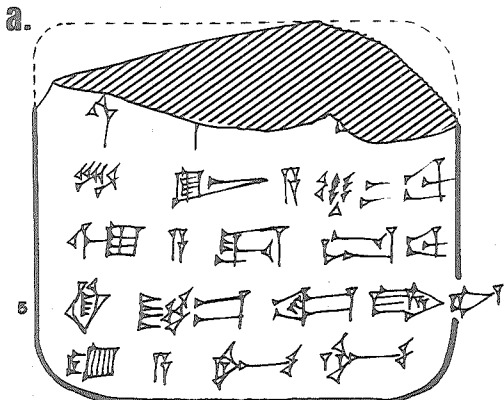

595 (MM 797)

Umma
-/-

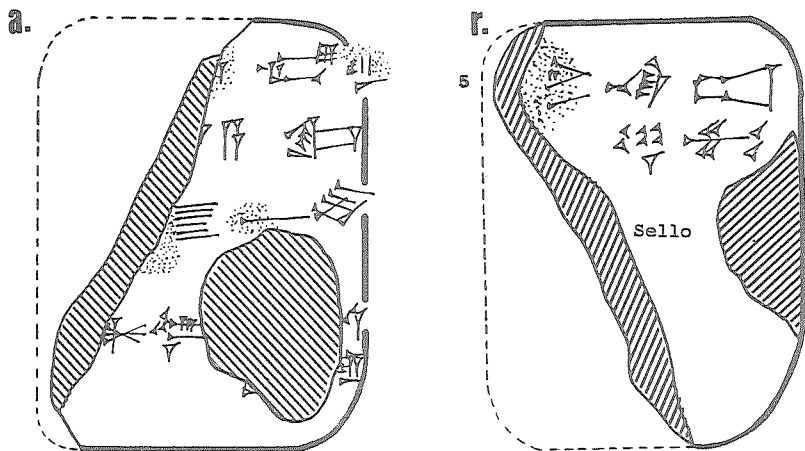

595. Sello:

i [⁴Su]-⁴Suen
lugal kal-ga
lugal Uri₂/⁴ma
lugal ⁴Ub-/da limmu₂-ba

ii Gu-du-du
dub-sar
dumu Da-da-ga
arad₂-zu

596 (MM 799)

Drehem
[después de ŠS3]/viii 6 ix/-

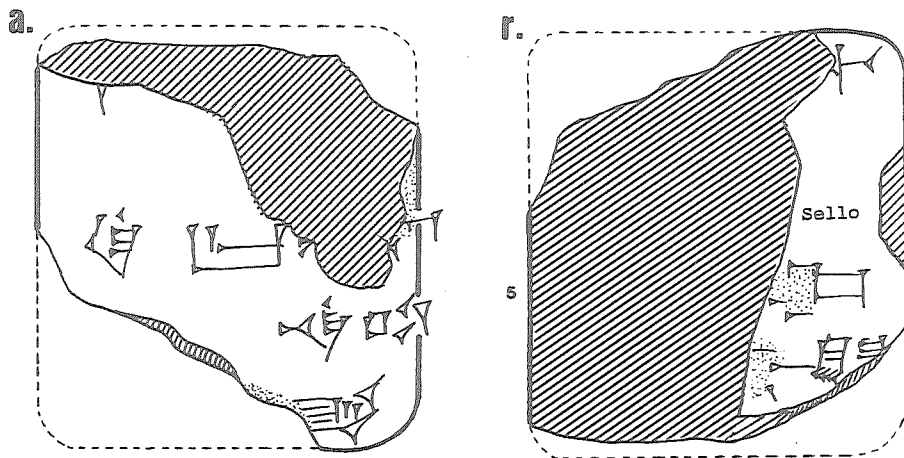

597 (MM 800)

Umma
ŠS3/-/- (i-xiii, viii-xiii)

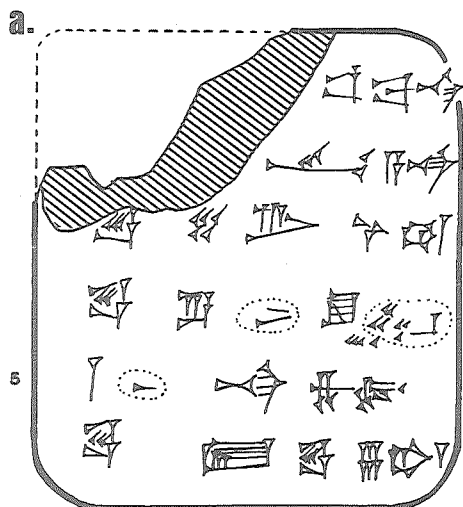

594 (MM 796)

Umma
AS7/-

594. Sello:

Ur-⁴Sul-pa-⁷e₃⁷
[...]
[dumu ...] ⁴[...]

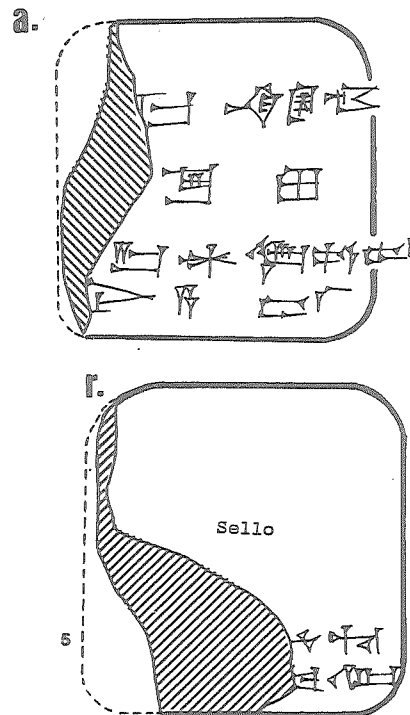

596. Sello:

D[u₁₁-ga dub-sar]
dumu ⁷Lu₂-[⁴Nin-gir₂-su]
sipa na-⁷kab⁷-[num]

597. Sello:

Da-[gu]
dumu Lugal-ur₂-r[a-ni]

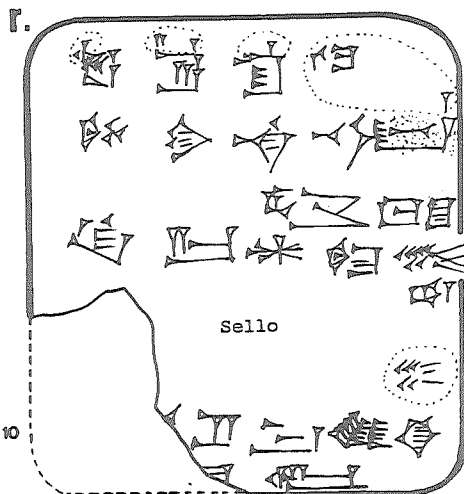

598 (MM 802)

?
[]

Reverso destruido

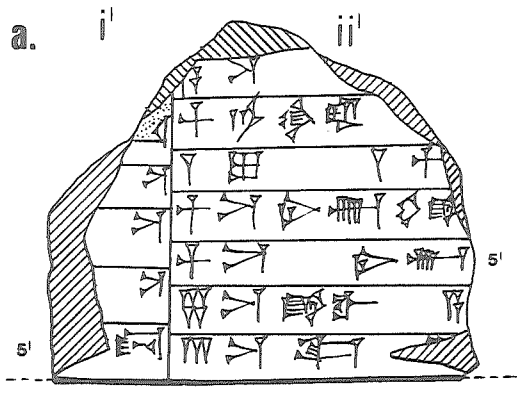

599 (MM 803)

Umma
AS3 4 SS8 6 9/ii?/-

599. Sello:

[Ur-...]
dub-[sar]
dumu Lugal-[...]

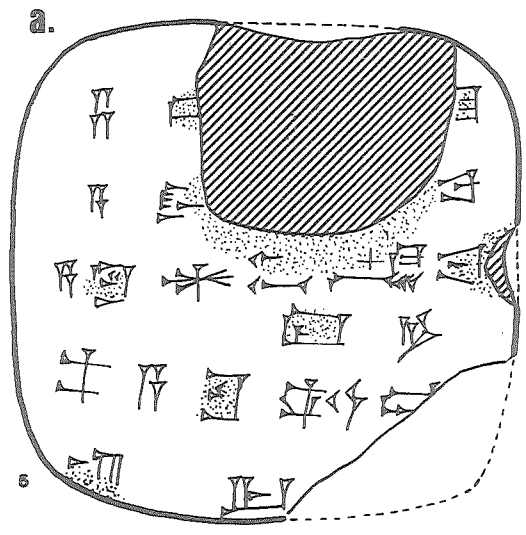

600 (MM 805)

Umma
AS7/vi/[?]

600. Sello:

[...]
dub-s[ar]
dumu Ur-ša₂-[ga]

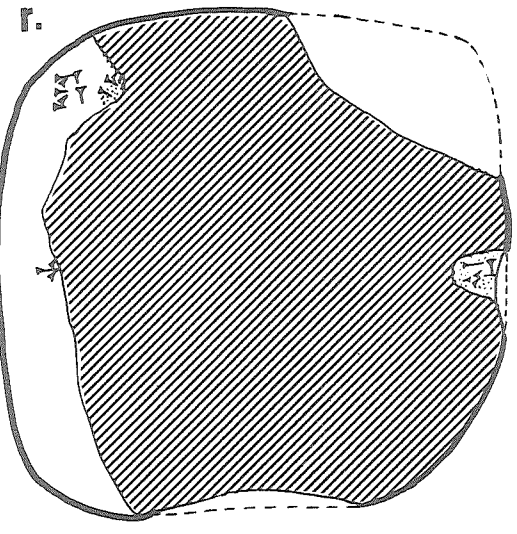
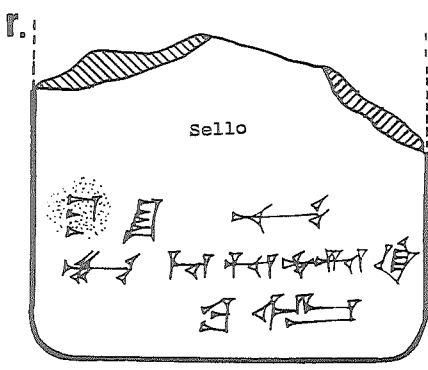
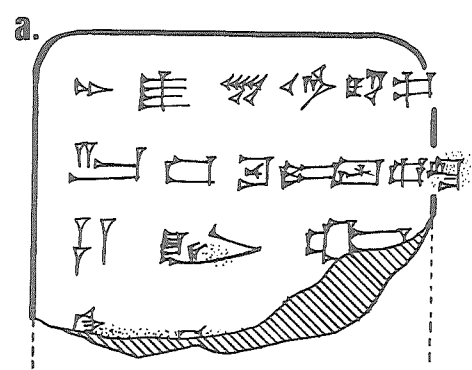

601 (MM 806)

Umma
AS6/[]

601. Sello:

Lugal-nig₂-lagar-e
dub-sar
dumu Da-da

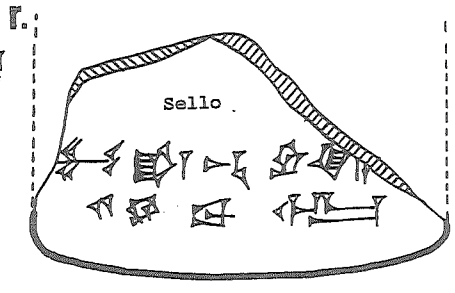
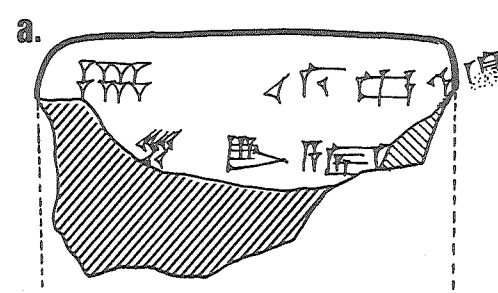

606 (MM 838)

Umma
ŠS2 6 3/-/-

Anverso destruido

602 (MM 807)

Umma
Š34/x/-

602. Sello:

Lugal-^re₂-ma[h-e]
dub-sar
dumu Lugal-ku₃-ga-ni^r

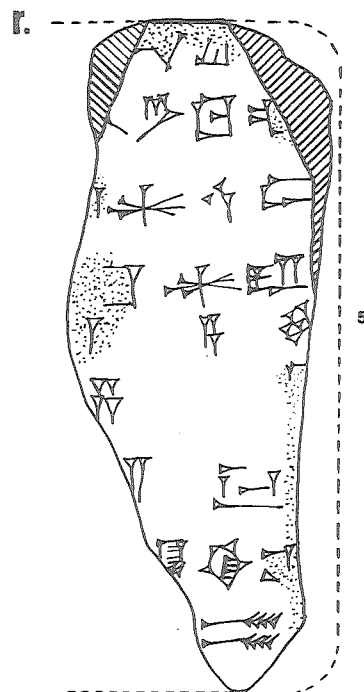
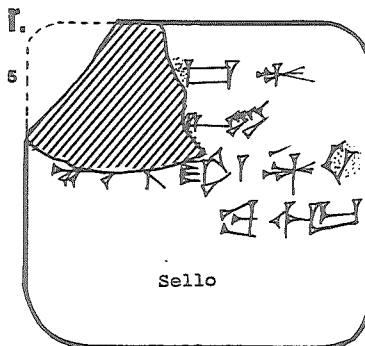
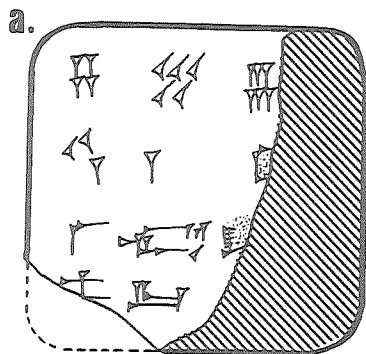

603 (MM 827)

Lagaš
[]

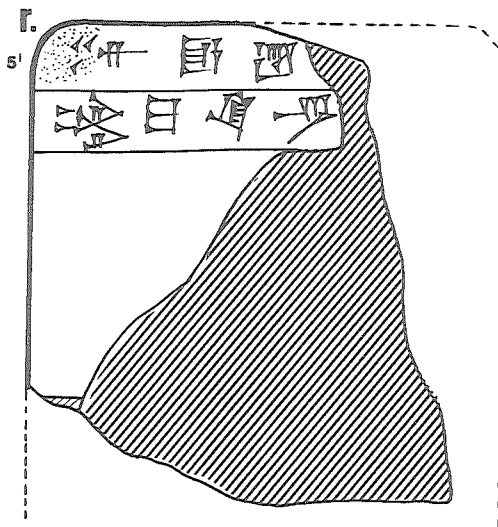
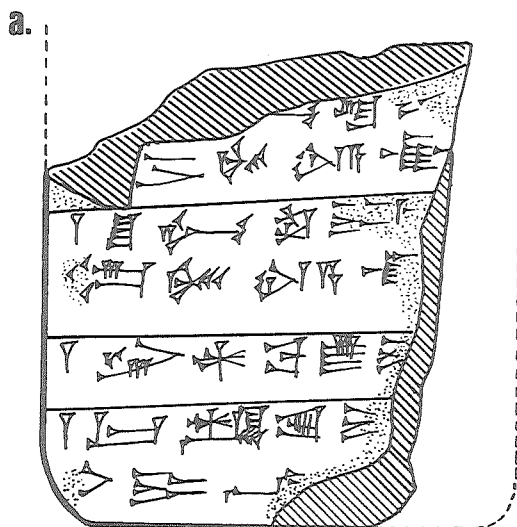

606. Sello:

Šeš-kal-[la]
dub-[sar]
dumu Na-[di]

604 (MM 834)

?
[]

Anverso destruido

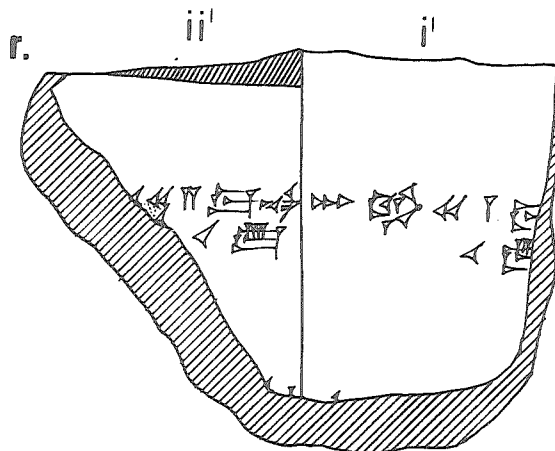

605 (MM 836+953 (+) 957)

Umma
AS9/-/-

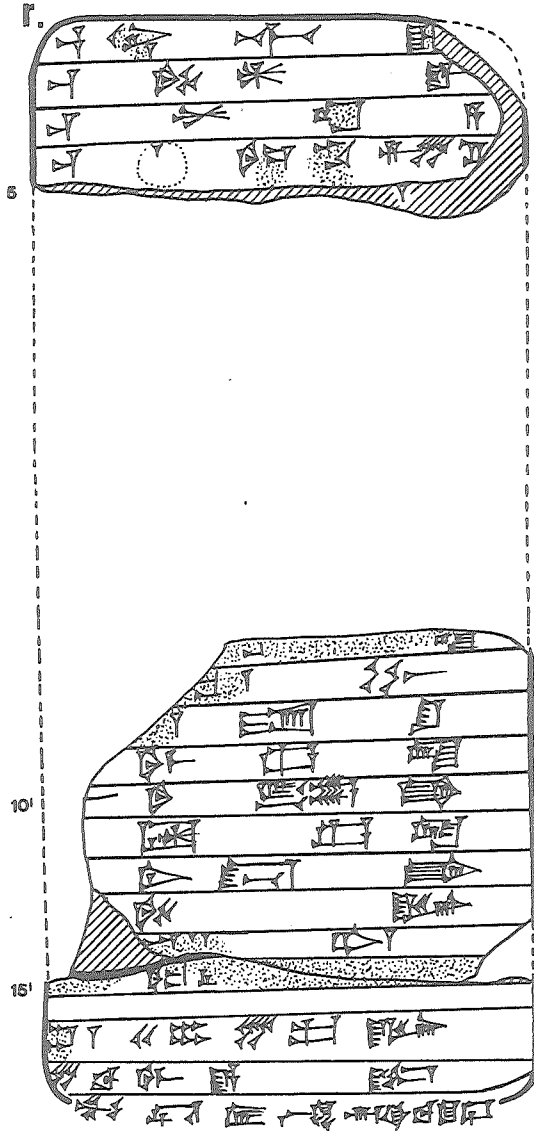
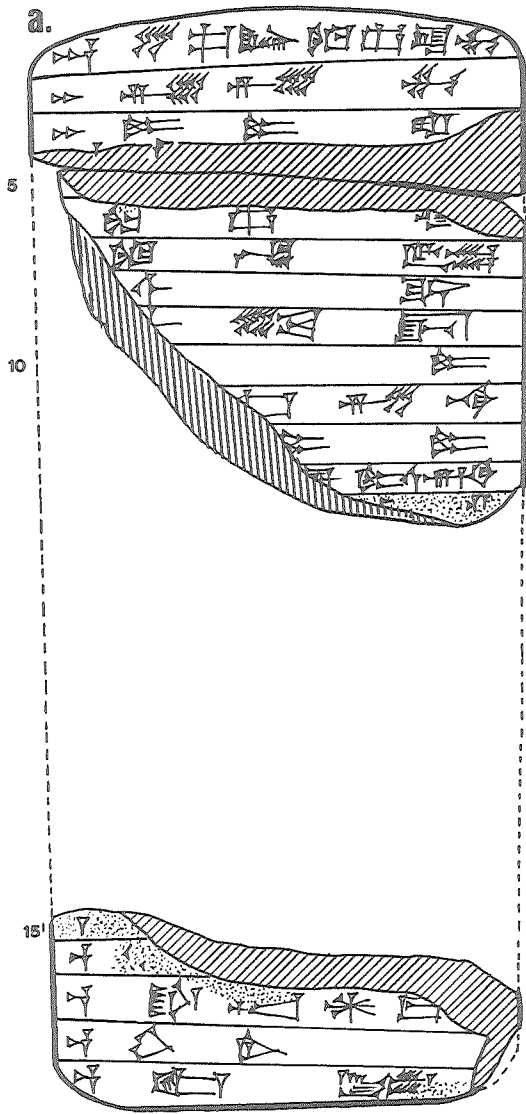

609 (MM 851)

Umma
ŠS1/i/-

609. Sello:

Lugal-a₂-zi-da²
dumu Lugal-ku₃-ga-n[i]

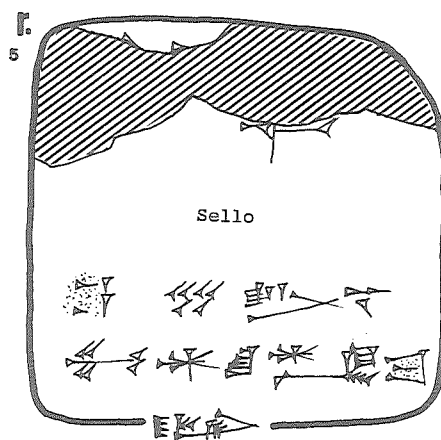
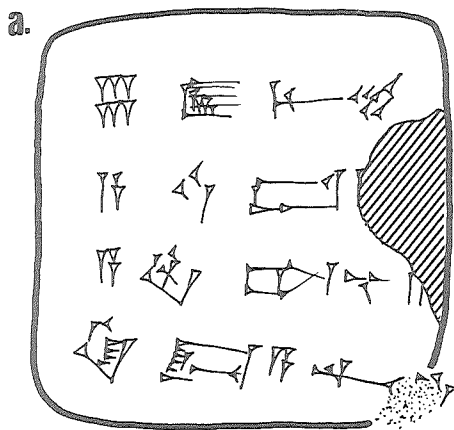

607 (MM 844)

Lagaš
AS7/-

608 (MM 848)

Lagaš
-vi/-

608. Sello ilegible

Tablilla

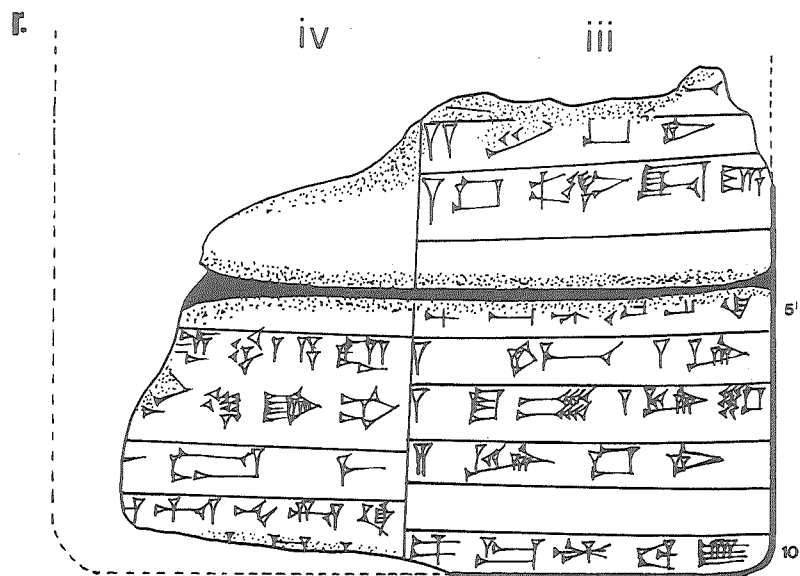
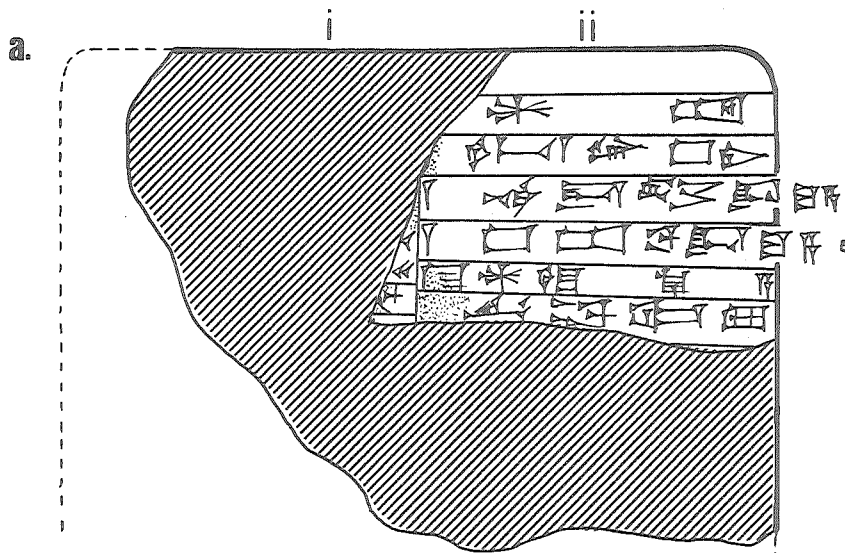
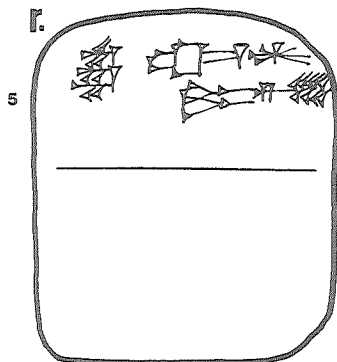
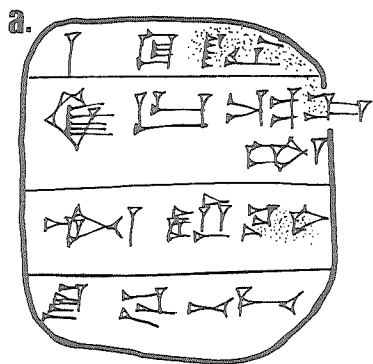

Envoltorio

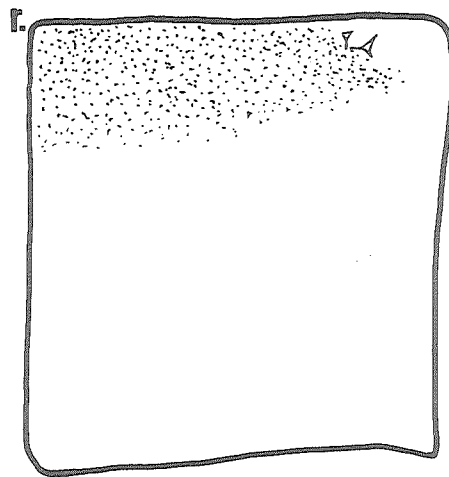
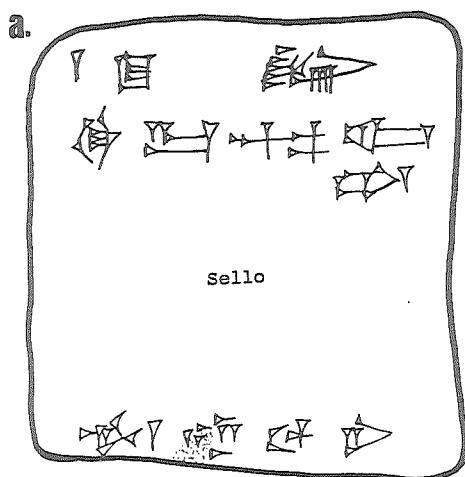

610 (MM 852)

Umma
[]/-/

610. Sello:

Lu₂-Šara₂
dumu Da-zi-gi₄-na

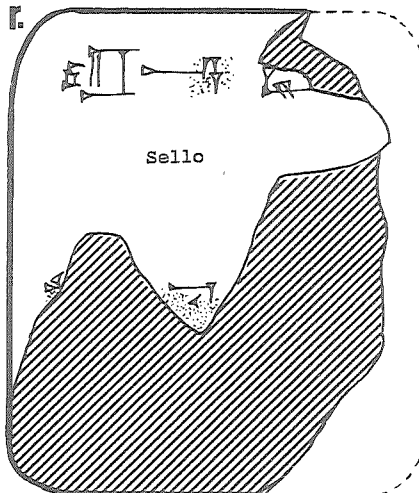
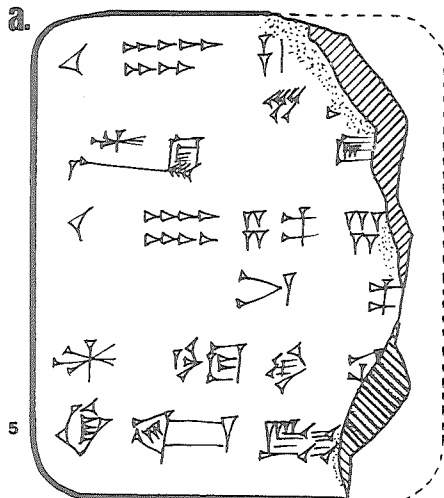

611 (MM 853)

Umma
SS4/-/

611. Sello:

[A]-kal-[la]
dub-sar
dumu Lu₂-ša₂-[ga]

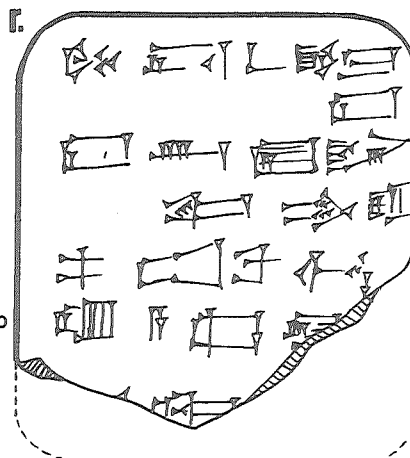
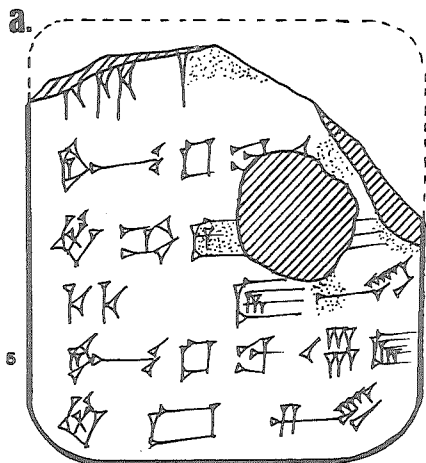

612 (MM 858a)

Umma
[]

a.

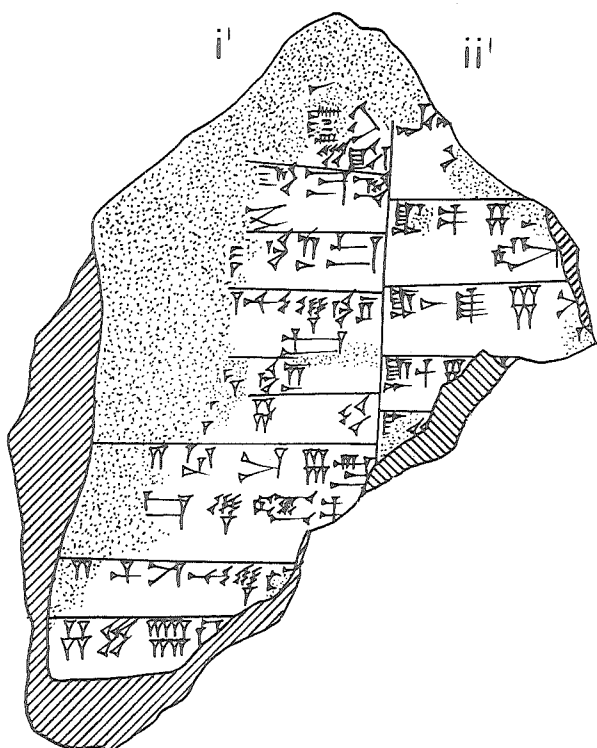

613 (MM 867)

?
[]

Anverso' destruido

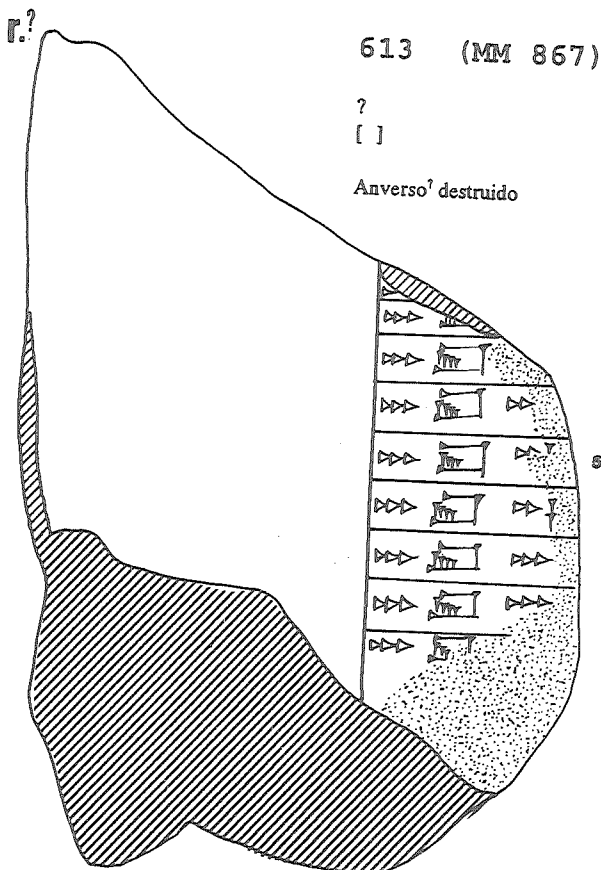

Quizás misma tablilla que n° 512
Reverso destruido

614 (MM 869+1131)

Umma
[]

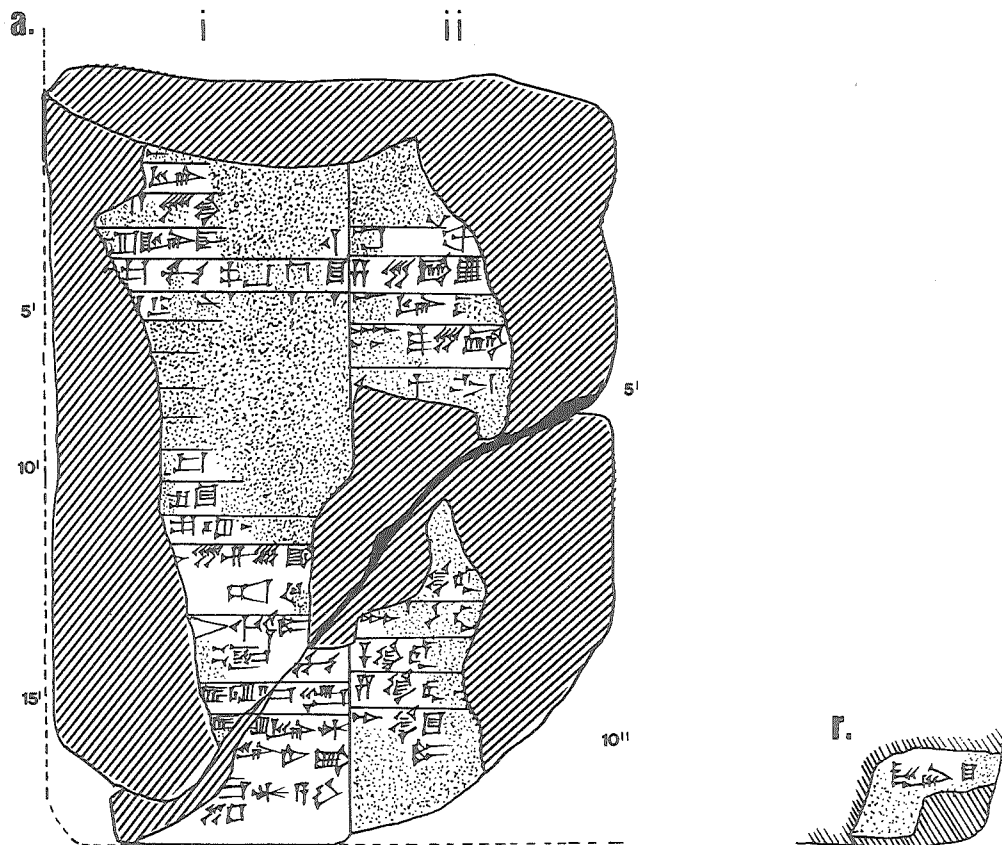

615 (MM 888)

Umma
AS41/-

615. Sello ilegible

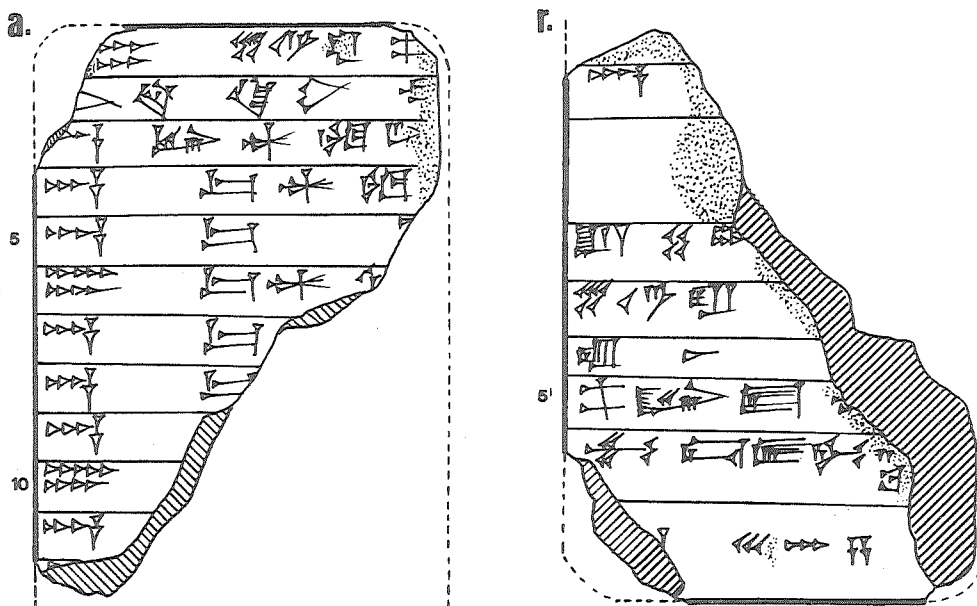

616 (MM 891)

Umma'
[]

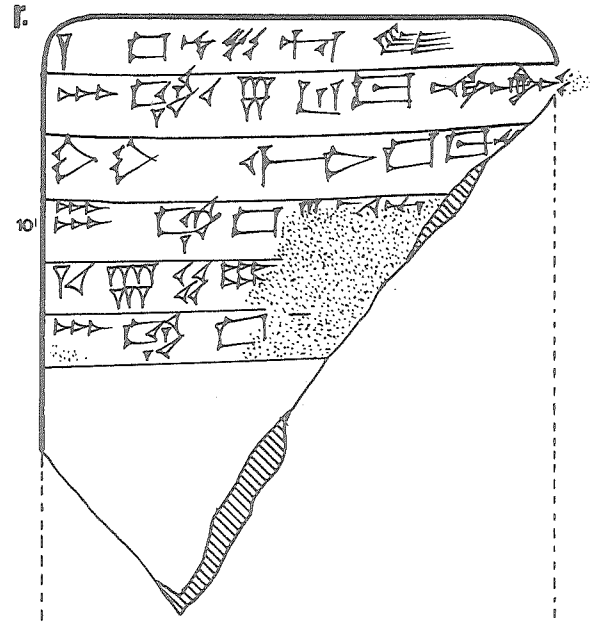
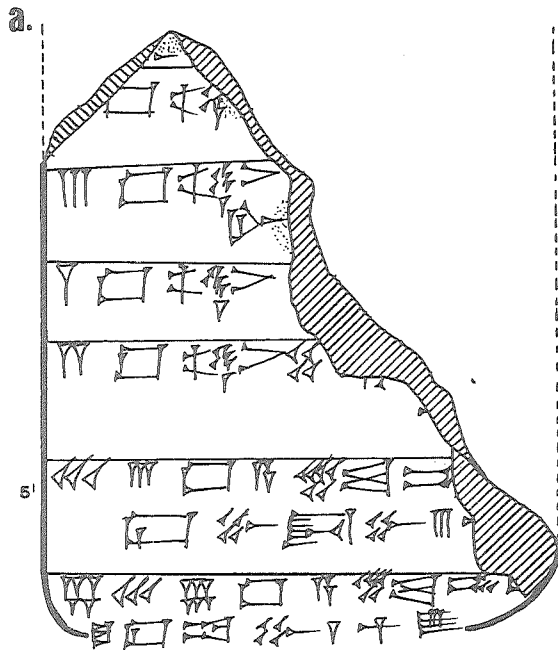

617 (MM 895b)

Umma
[]/vi/-

617. Sello:

Ur-[zu]
dub-[sar]
dumu A₂-zi-'da'

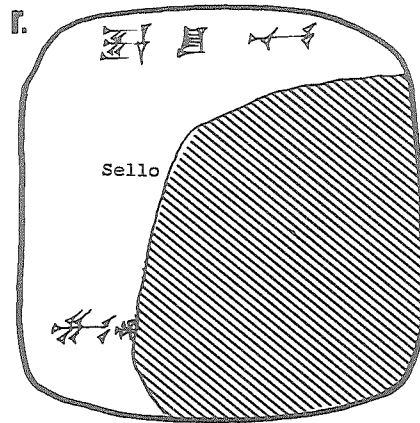
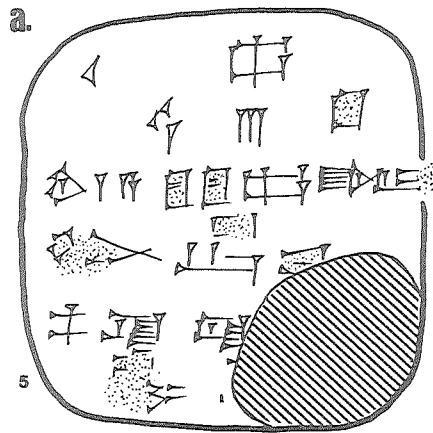

618 (MM 906)

?
[]

Perdido aprox. 2/3 de la tablilla

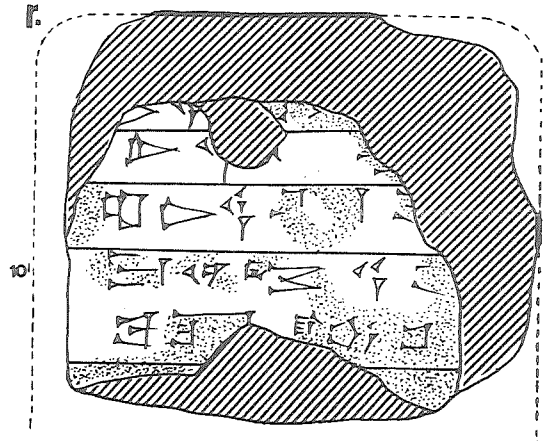
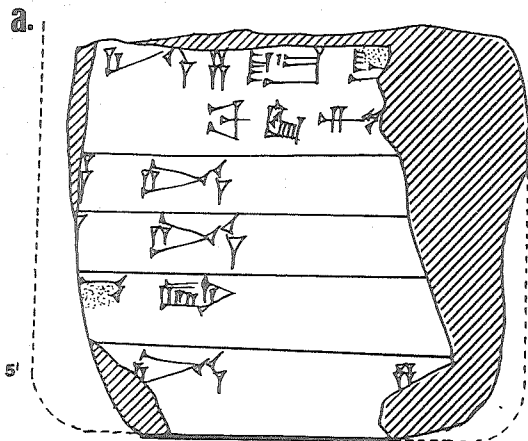

619 (MM 907)

Tablilla demasiado destruida para copia
Se conserva: [... b]ala-t[a ...] / [... m]u-TUM₂ [...]

620 (MM 908)

?
[]

Anverso destruido

622 (MM 911)

a?

?
[]

Reverso³ destruido (se conserva únicamente el signo U₂)

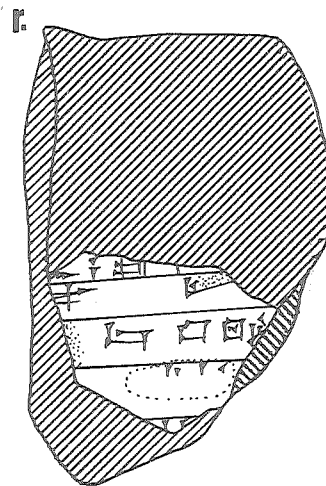
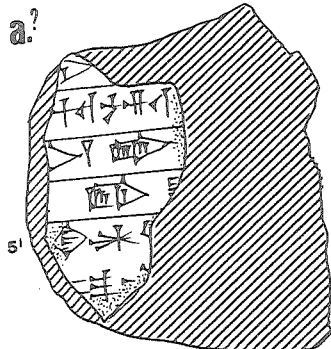

621 (MM 909)

?
[]

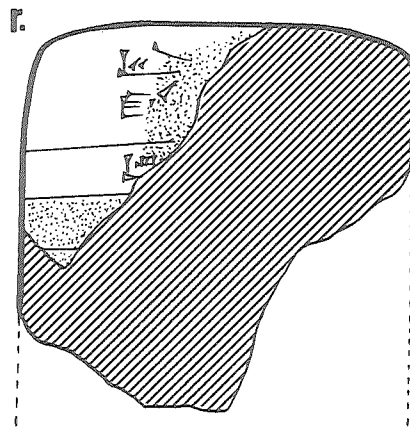
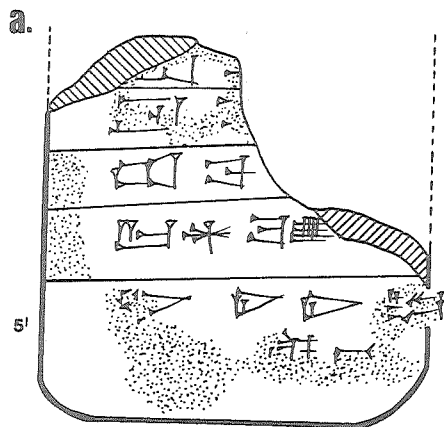

623 (MM 912)

?
[]

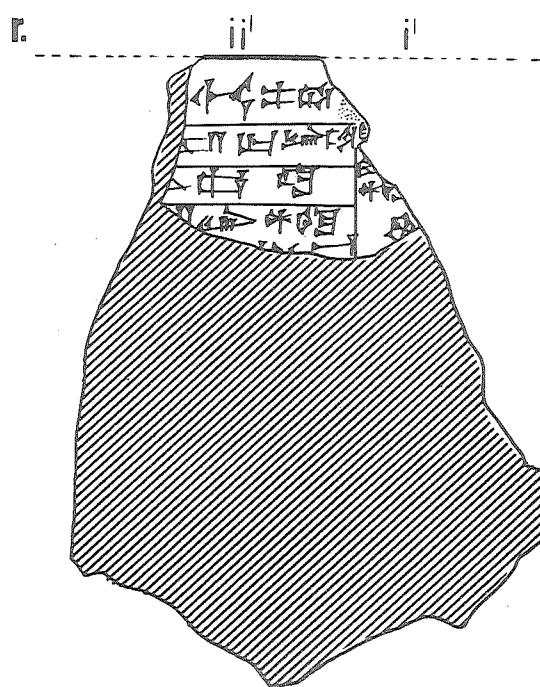
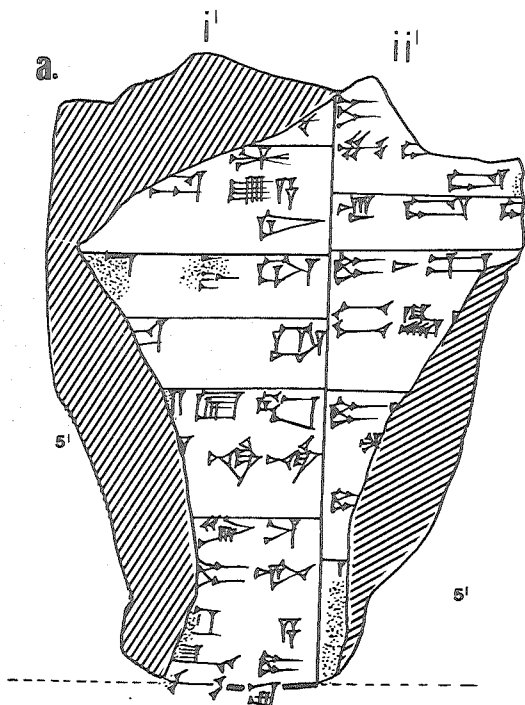

624 (MM 913)

?
[]

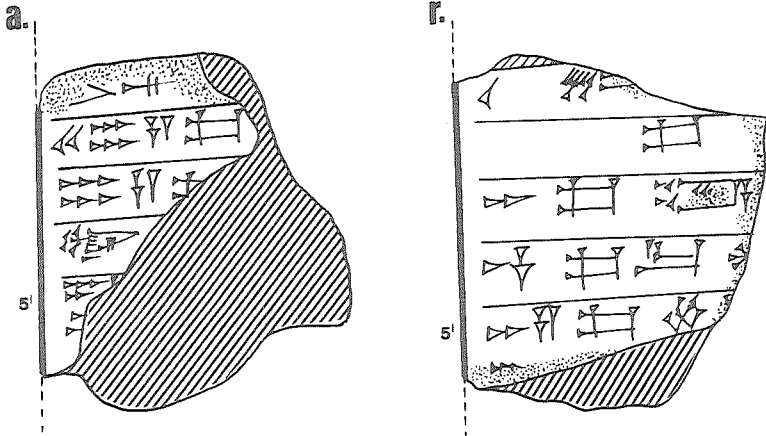

625 (MM 915)

Lagaš¹
Š46 6 AS3/[]

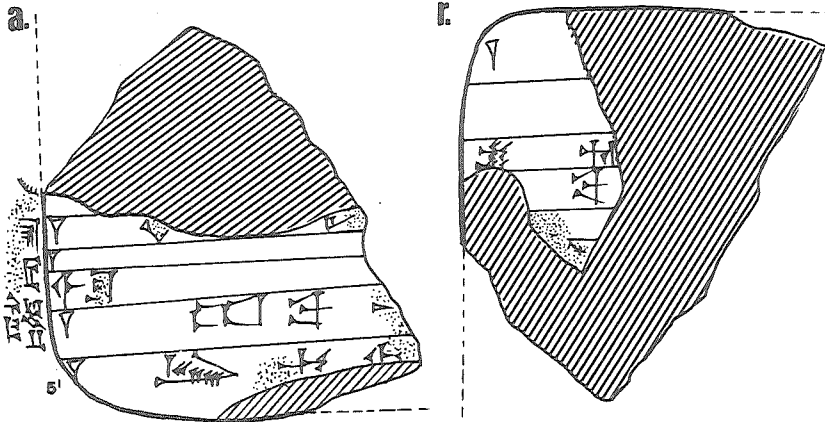

627 (MM 918)

Umma
[entre AS4-ŠS5]

627. Sello:

I₇-pa-[e₃]
dub-sar
dumu Lu₂-Šara₂
[sa₁₂]-[du₂-ka]

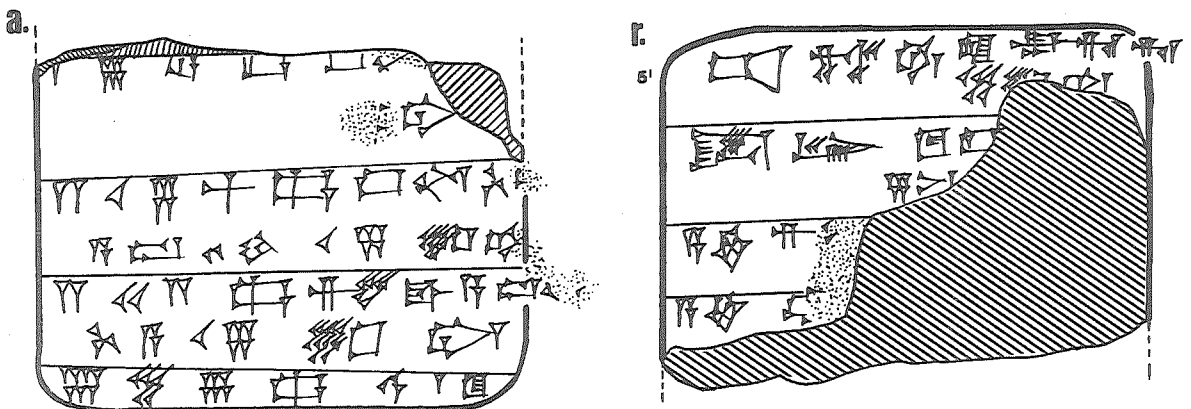

626 (MM 917)

Lagaš¹
[]

Reverso destruido

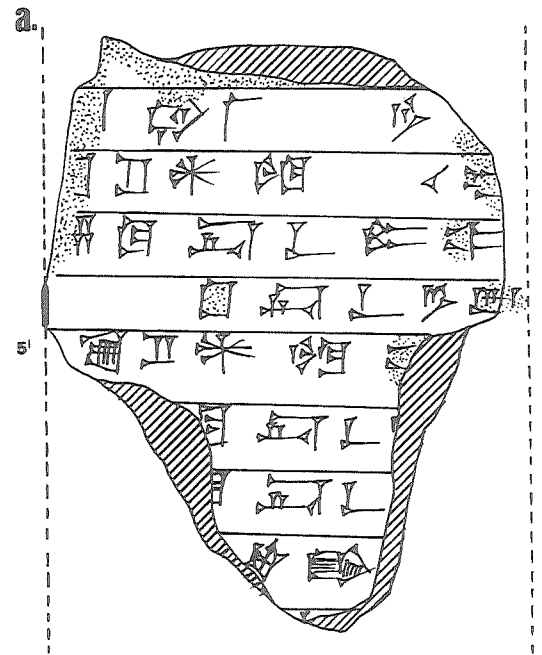

628 (MM 920)

Drehem
ŠS1/vi/-

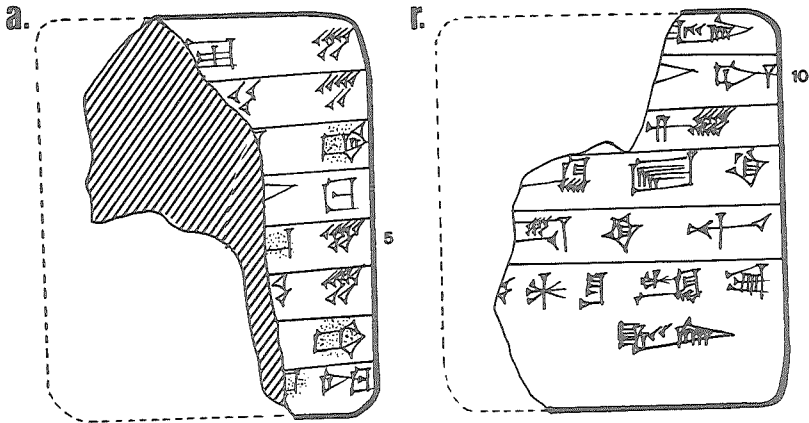

631 (MM 923)

Drehem
Š42 6 AS6/iii/-

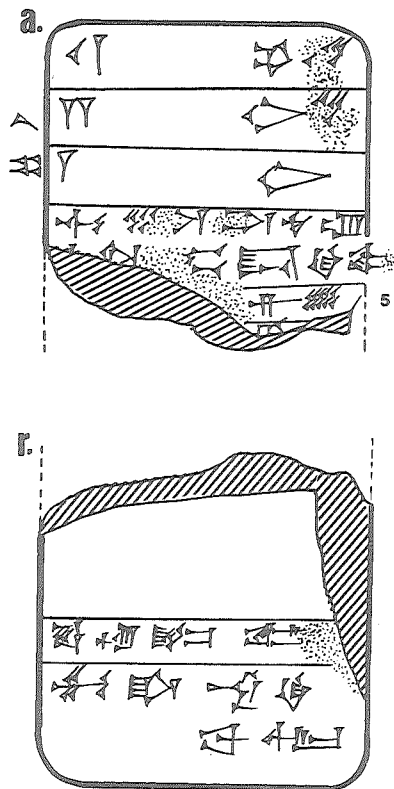

629 (MM 921)

Umma
ŠS.../i/-

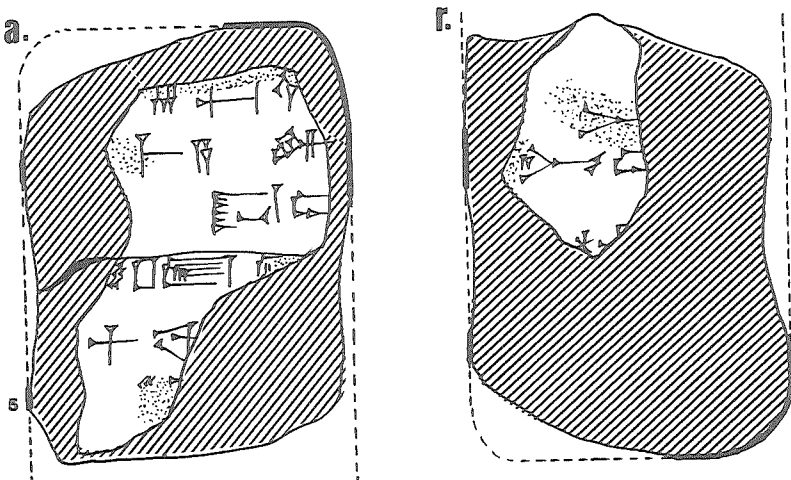

629. Sello:

- i [Šu-Šuen]
[lugal kal-ga]
lugal [Uri₂]^{ti}-ma
lugal ^dUb-/da limmu₂-ba
- ii [Gu-du-du]
[dub-sar]
dumu Da-[da-ga]
arad₂-[zu]

630 (MM 922)

Umma⁷
AS2/[]

Perdido aprox. 2/3 de la tablilla

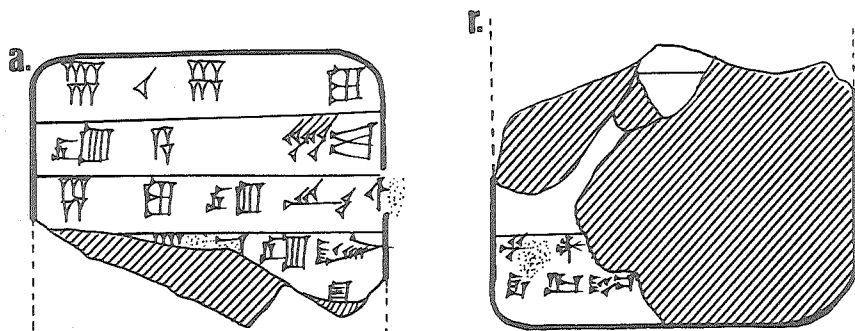

632 (MM 924)

Lagaš
[]/21

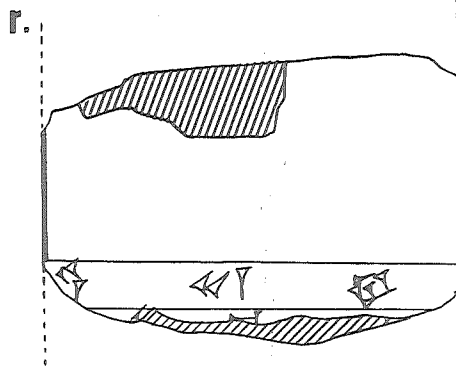
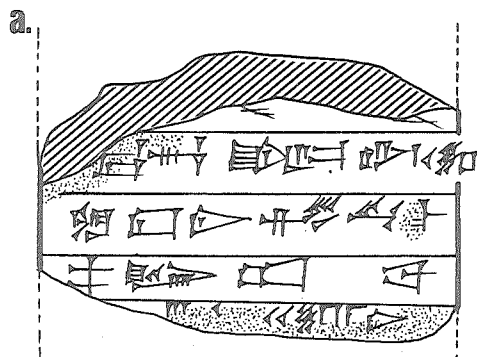

634 (MM 927)

?
[]

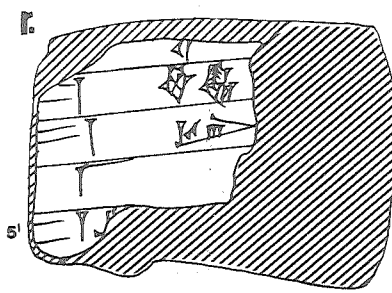
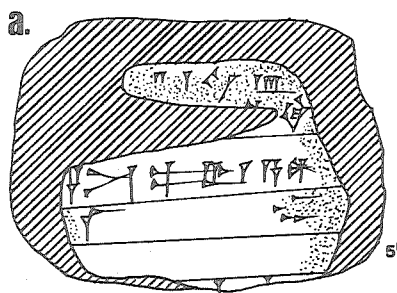

635 (MM 928 (+) 943)

Umma?
[]

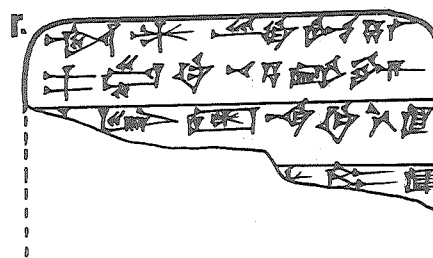
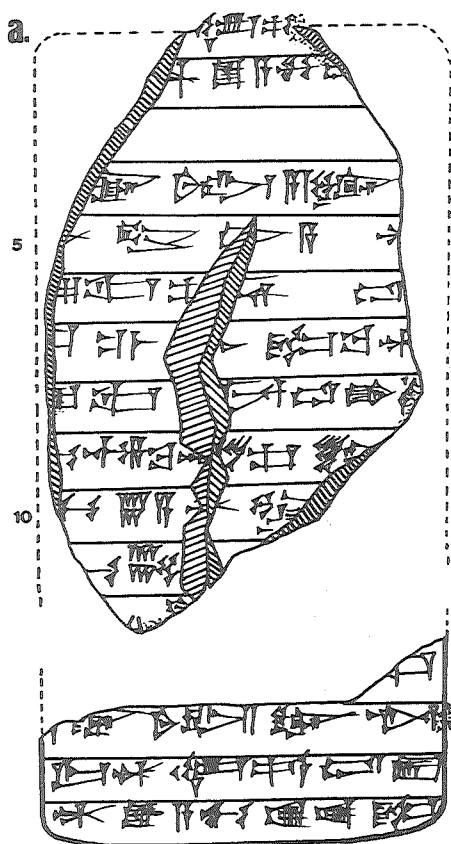

633 (MM 926)

Umma
-/-

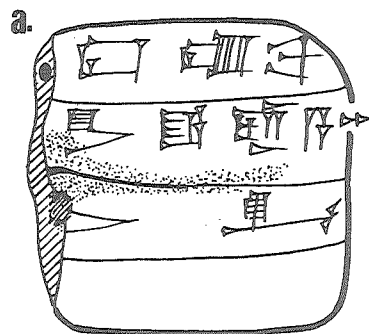

Etiqueta de contenedor de tablillas
con orificios para cuerda
Reverso anepigráfico

636 (MM 930)

Umma
[]

Reverso destruido

636. Sello:

[...] Lu₂/Lugal-[...]

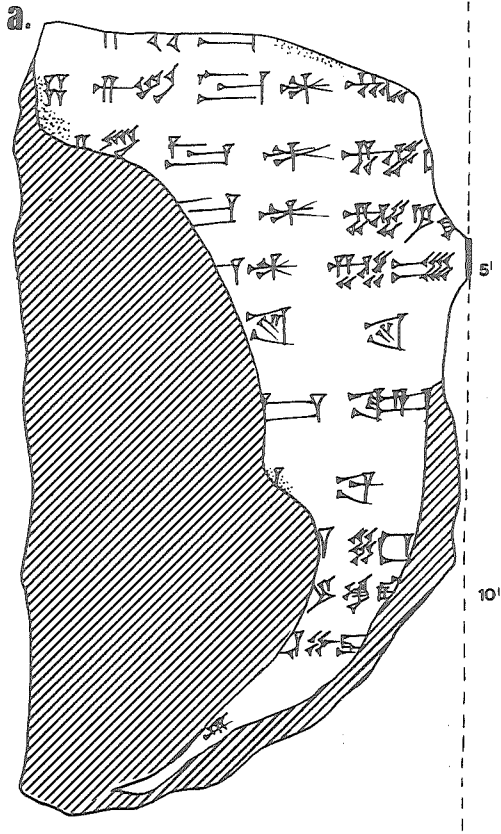

637 (MM 931)

?
[]

Reverso destruido y parte inferior anepigráfica

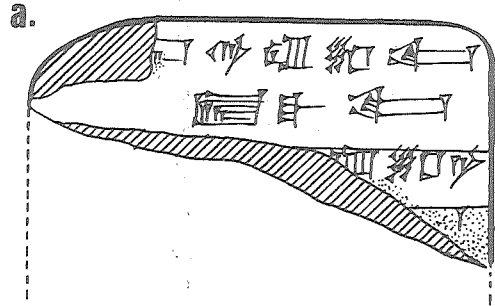

638 (MM 932)

Umma'
[]

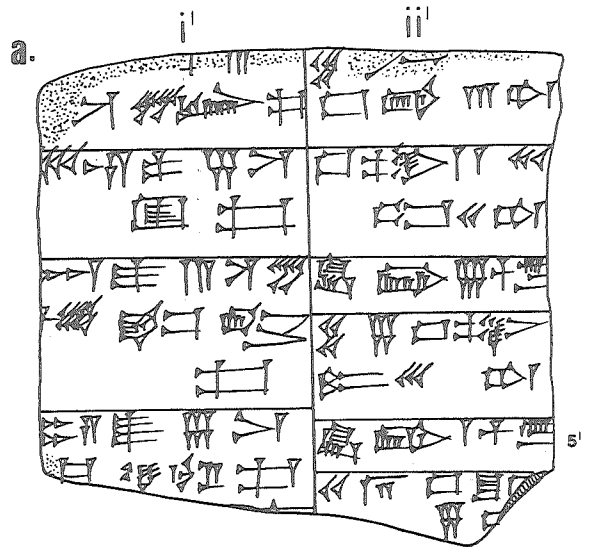

Tablilla serrada en bordes superior, inferior e izquierdo, y reverso destruido y retocado con fines comerciales

639 (MM 934)

Umma
[]

639. Sello:

Lu₂-kal-la
dub-sar
dumu Ur-e₁₁-e [kuš,]

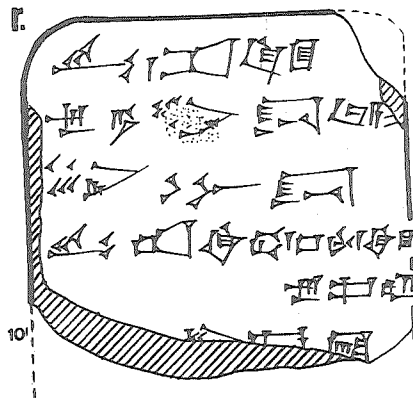

640 (MM 935)

Umma
ŠS2/iv/-

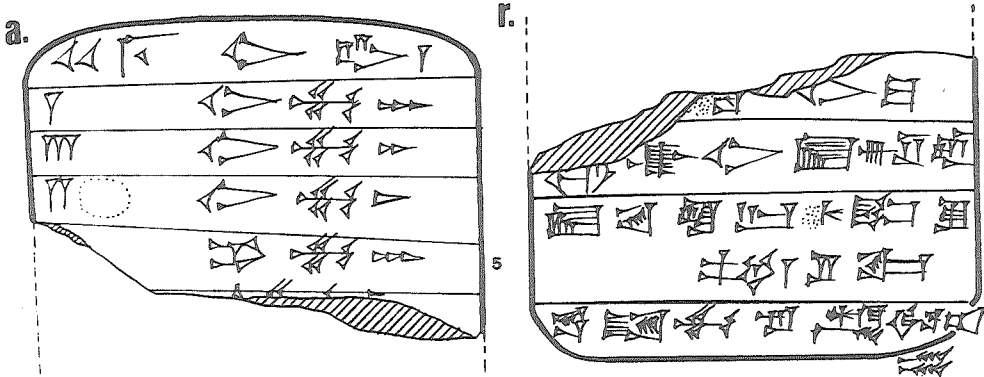

642 (MM 939)

Lagaš¹
[]

Reverso destruido

641 (MM 938)

Umma
[]

Reverso¹ destruido

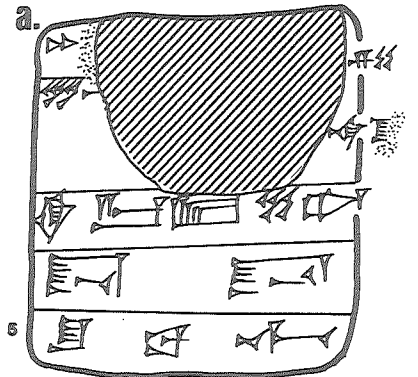
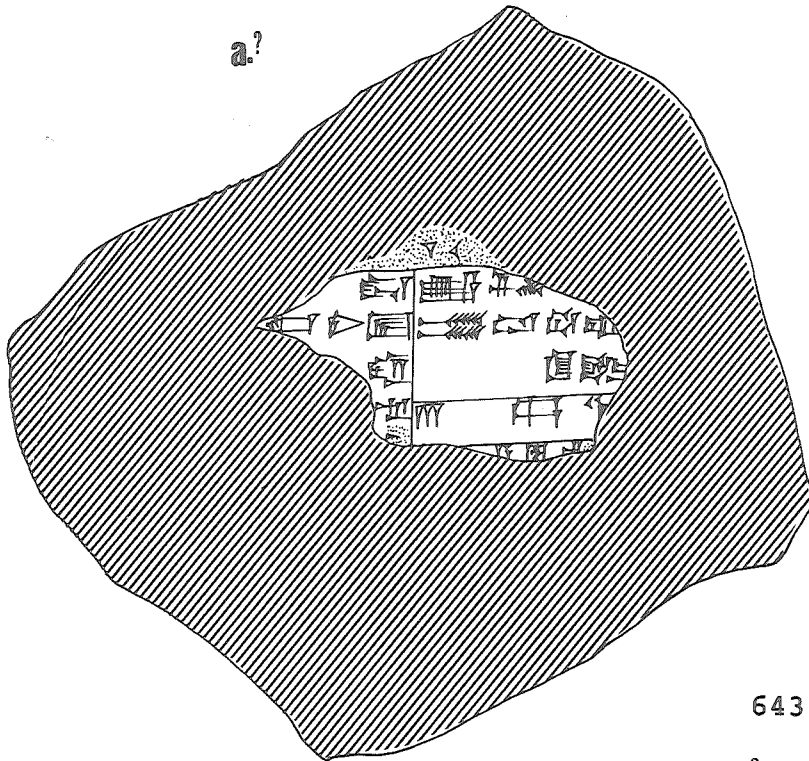

643 (MM 940)

?
[]

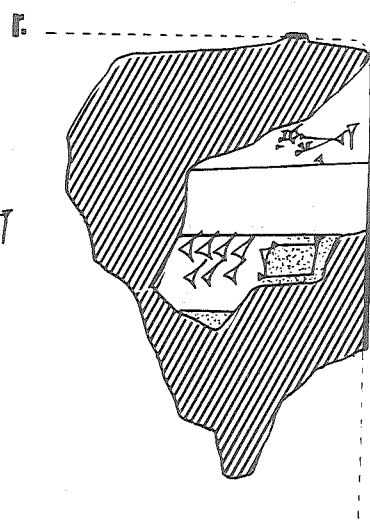
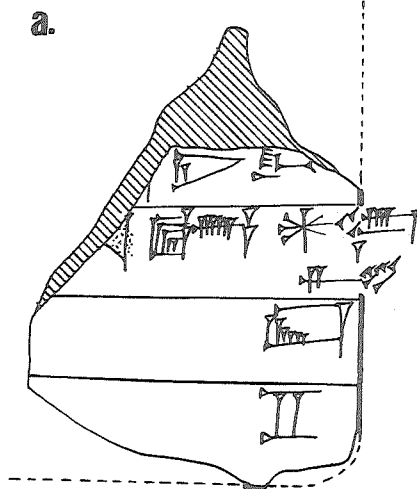

644 (MM 941)

Umma
AS8/-/

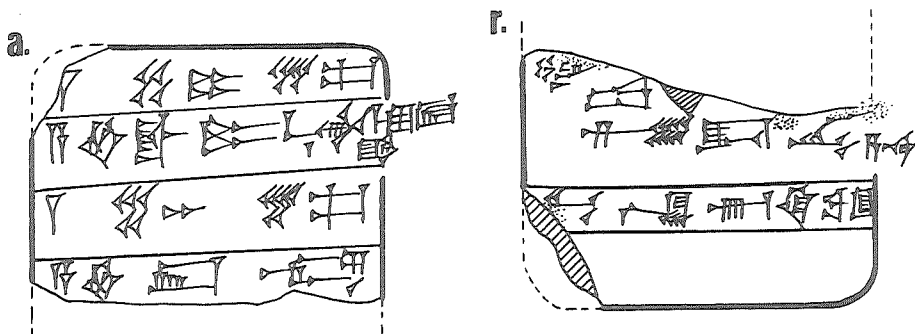

647 (MM 945)

Drehem
AS4 6 AS9/v/30

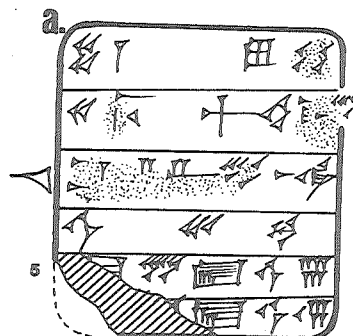

645 (MM 942)

?
[]

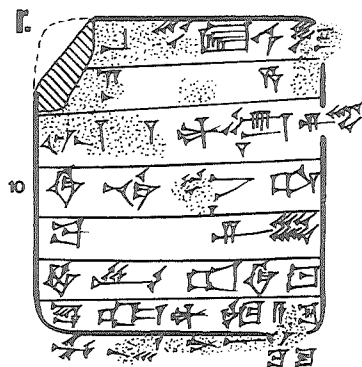
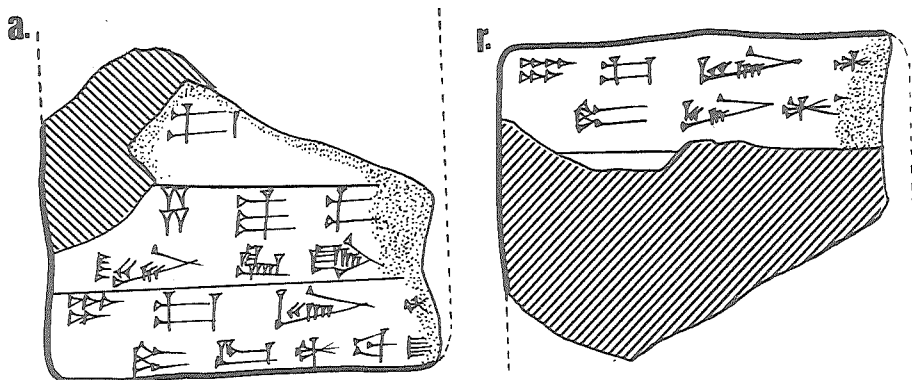

646 (MM 944)

?
[]

Anverso destruido

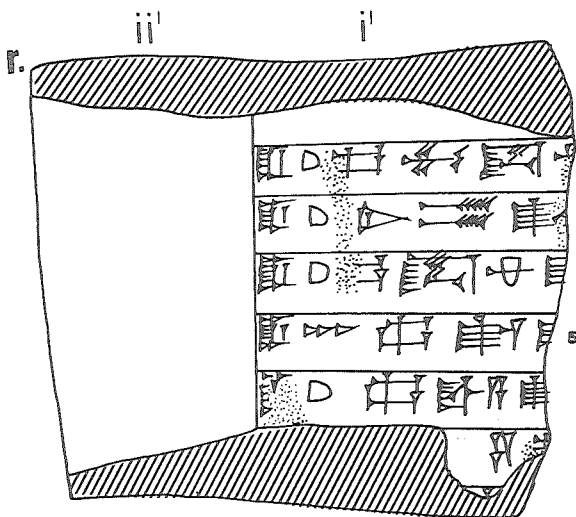

648 (MM 946)

?
[]

Reverso destruido

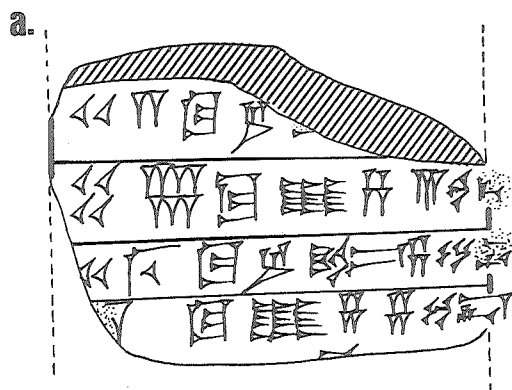

649 (MM 947)

?
S57/[]

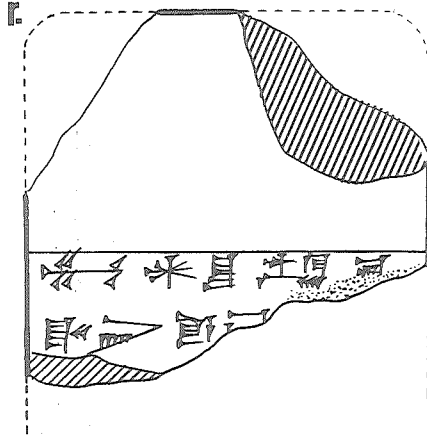
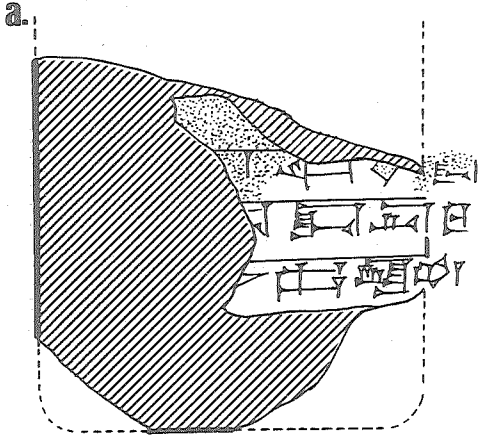

652 (MM 954)

Umma'
[]

Reverso destruido

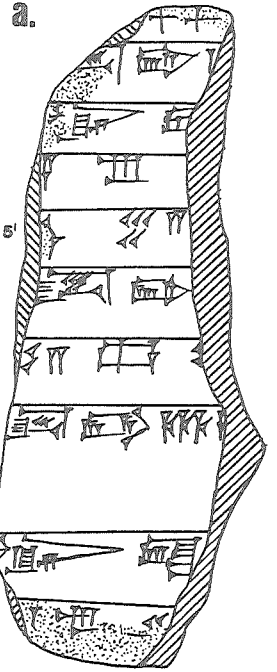

650 (MM 949)

Umma
S431-1-

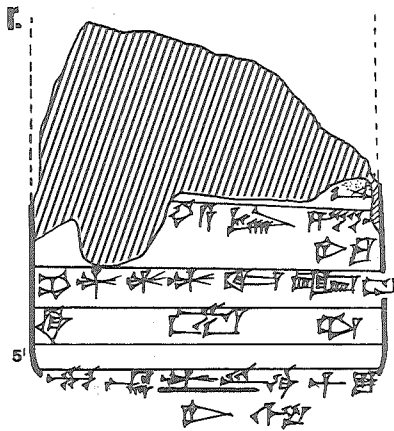
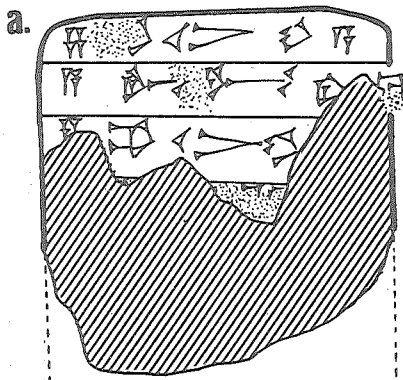

651 (MM 951)

Umma
[]

Reverso destruido

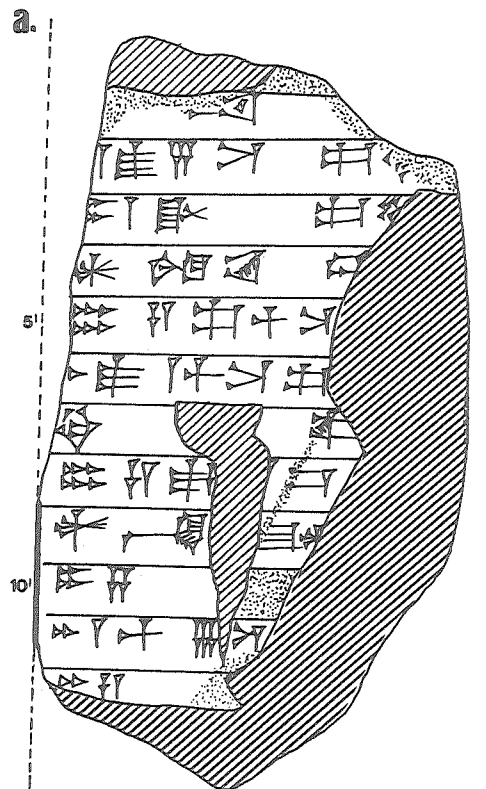

653 (MM 955)

Drehem
AS3/i/21

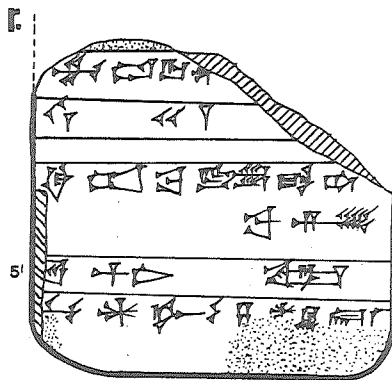
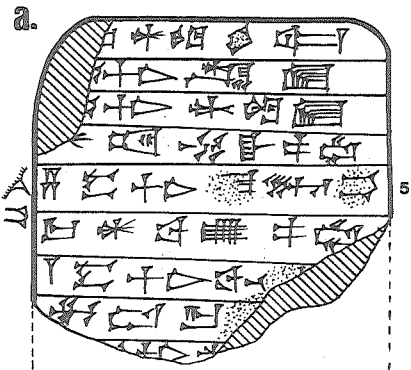

654 (MM 956)

Umma
[]

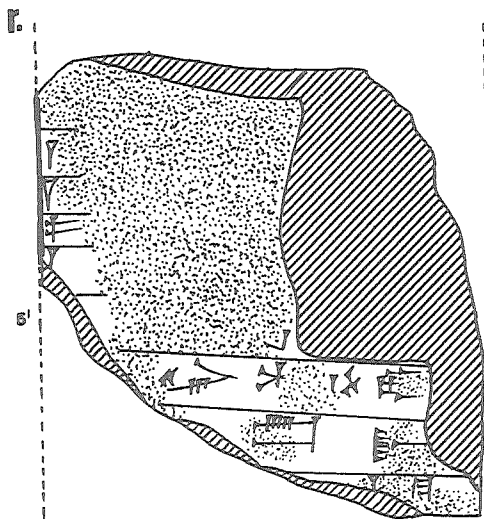
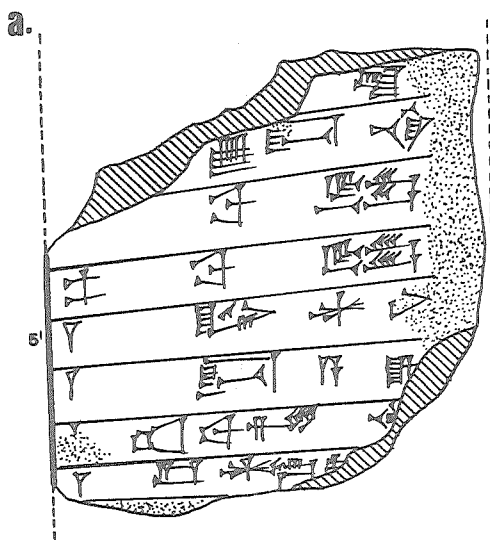

654. Sello:

- i Šu^d-Suen
lugal kal-ga
lugal Uri^{ki}-ma
lugal Ub^d-da limmu₂-ba
- ii A-a-kal-[la]
ens[i₂]
Umm[a^{ki}]/arad₂-[zu]

655 (MM 958)

655. Sello ilegible

Bulla anepigráfica sellada (escena de introducción a la divinidad) con impresiones interiores de cuerda

658 (MM 961)

?
[]

Reverso destruido

656 (MM 959)

?
[]

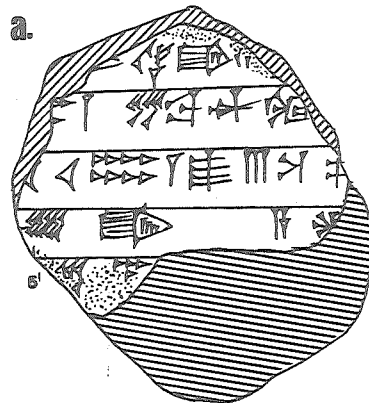
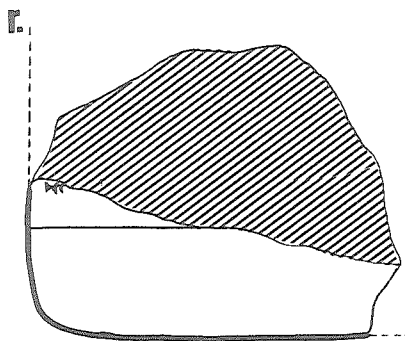
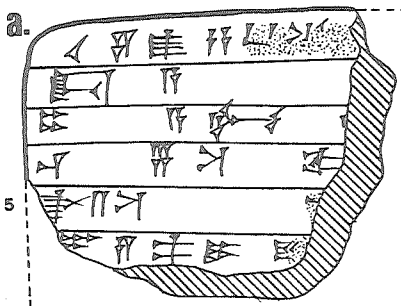

657 (MM 960)

Umma
ASS/vi-

Perdida aprox. media tablilla

657. Sello:

Lugal-ku₃-ga-[ni]
dumu Da-d[a⁷ ...]

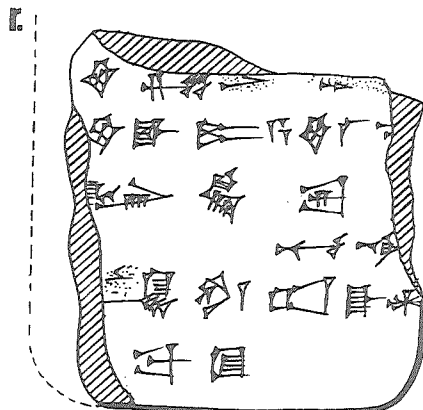
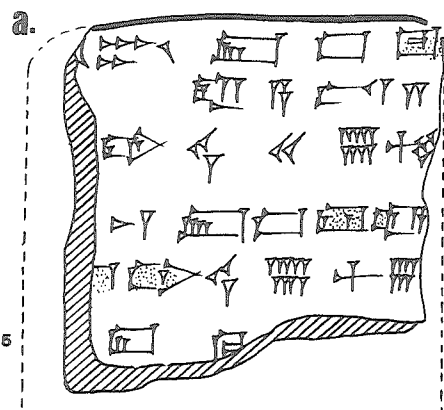

659 (MM 962)

?
[]

Perdido aprox. 1/4 de la tablilla

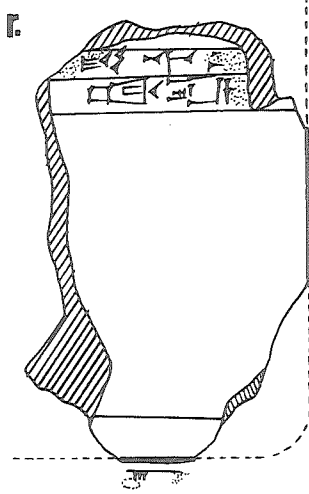
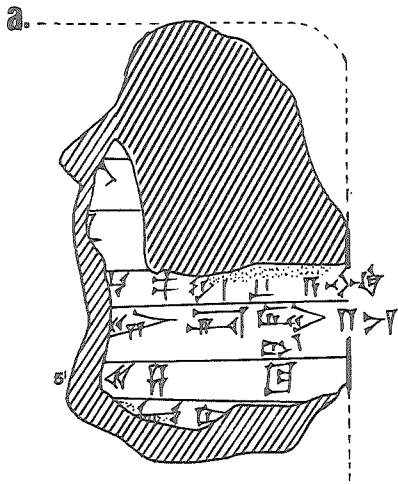

662 (MM 965)

?
AS4/[]

Anverso destruido

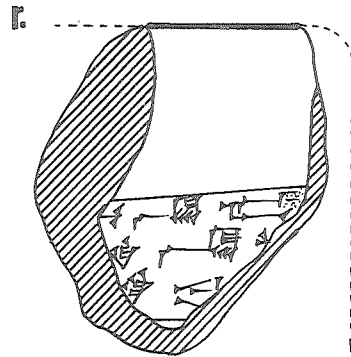

660 (MM 963)

?
[]

Reverso anepigráfico

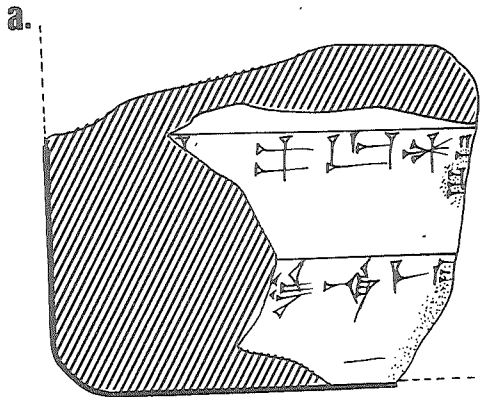

663 (MM 966)

Umma
[]

663. Sello:

Ur-Šul-pa-[e₃]
dub-sar
dumu Lugal-ku₃-ga-ni

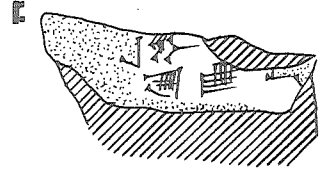
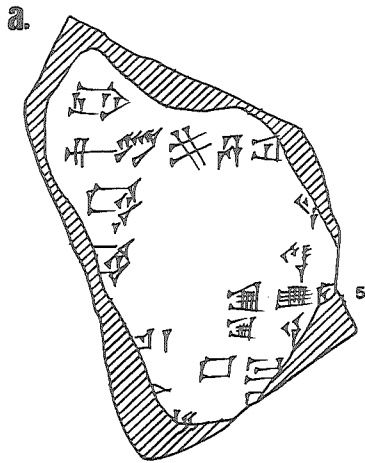

664 (MM 967)

Umma
Š34/-/-

Reverso destruido

661 (MM 964)

?
AS2/[]

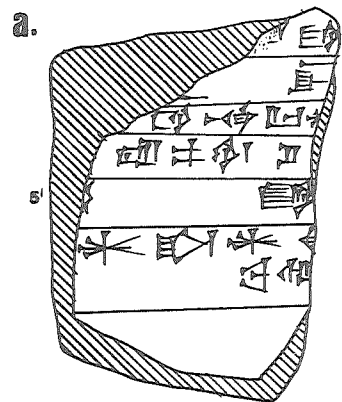
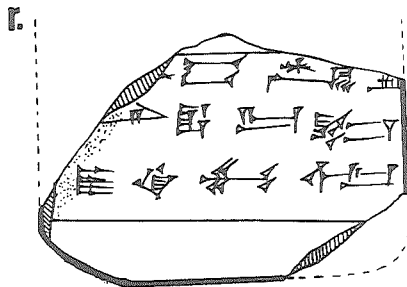
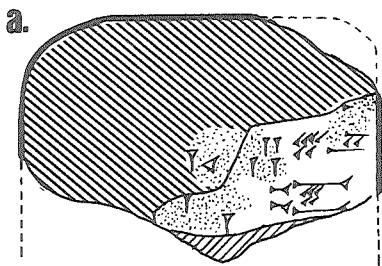

665 (MM 968)

Umma
[]

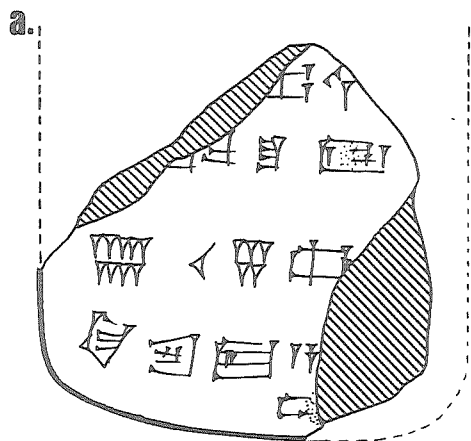

665. Sello:

Lugal-nig₂-lagar-e
dub-[sar]
dumu Da-da

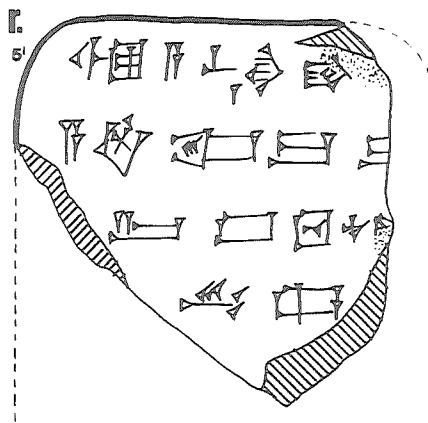

667 (MM 970)

?
AS4/-

Reverso anepigráfico

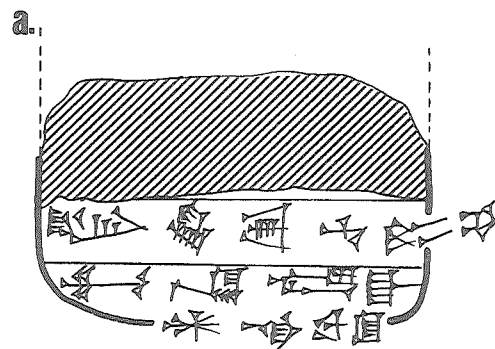

666 (MM 969)

Umma
[]

Tablilla originalmente con
dos columnas por cada cara

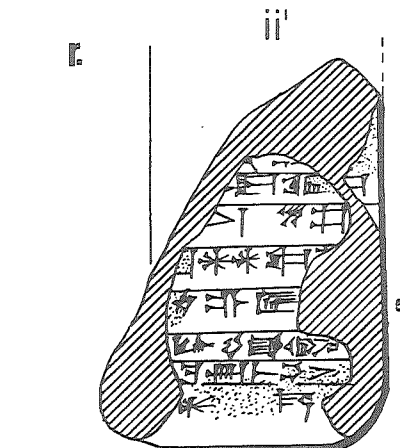
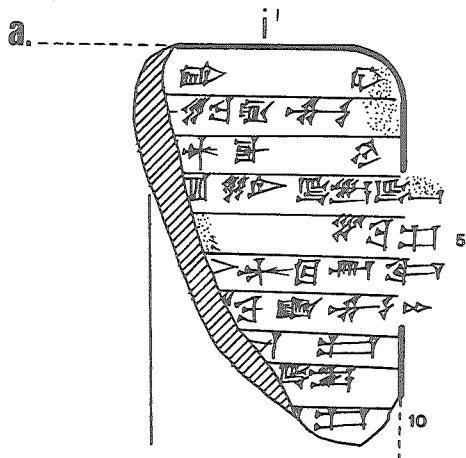

668 (MM 991)

Lagaš
AS1/-

668. Sello:

Ur-dam
dub-sar
dumu Ur-^d[...]

Tablilla

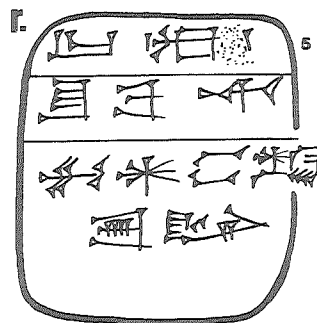
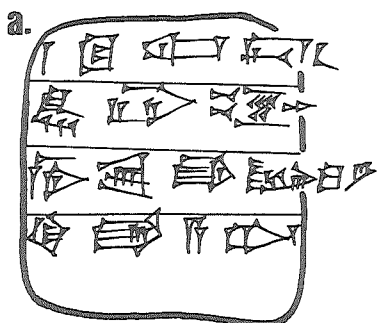

Envoltorio

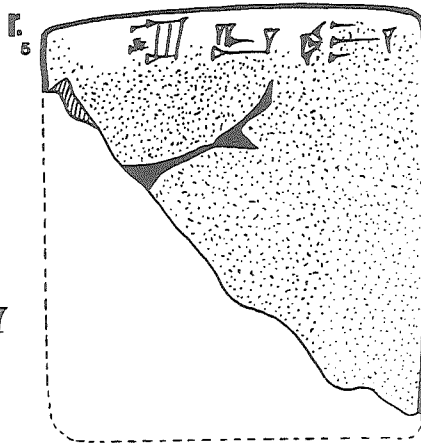
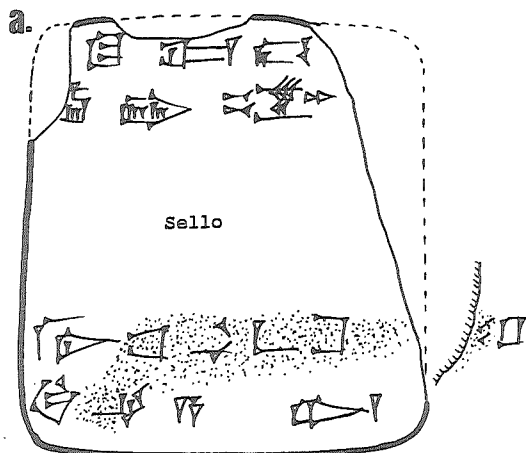

669 (MM 992)

Umma
AS4 6 9/[]/3

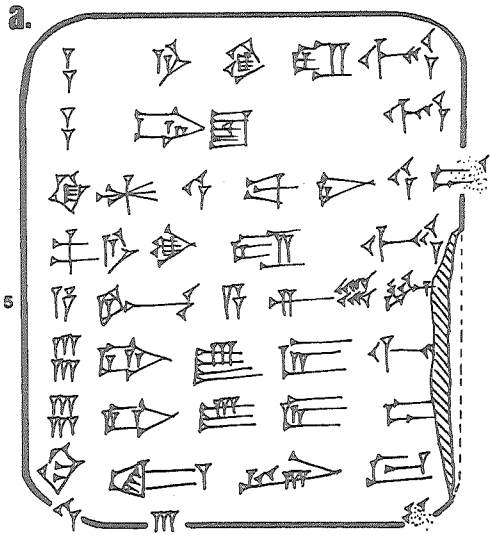

669. Sello:

[Ur-⁴Li₂-si₄]
[ensi₂ U[mma^{ki}]
Lu₂[...]
[...]
arad₂[...]

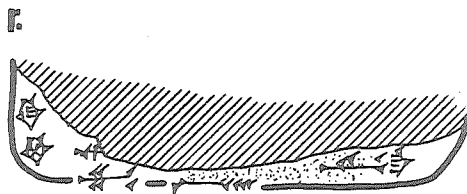

672 (MM 995)

Umma
ŠS9/ix/-

672. Sello:

Arad₂-[mu]
dub-sar
dumu [Šara₂-za-me]

670 (MM 993)

Lagaš
Š34/iii/-

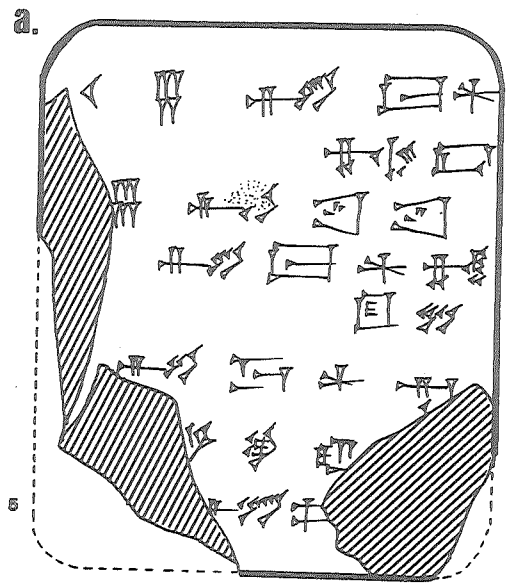
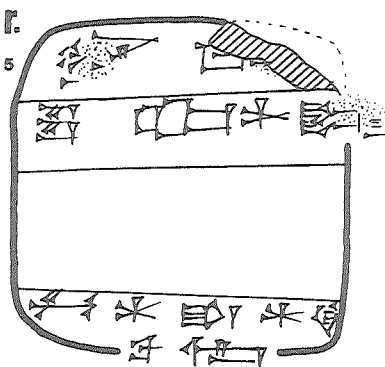
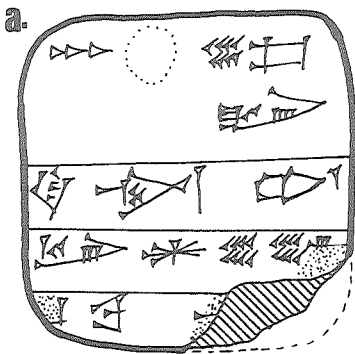

671 (MM 994)

Umma
ŠS71/-

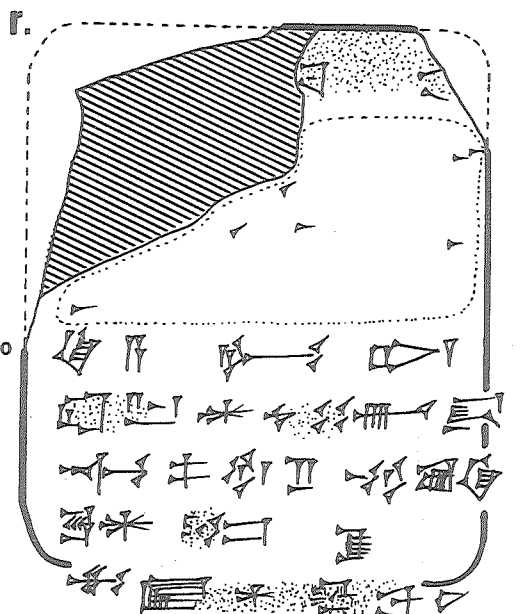
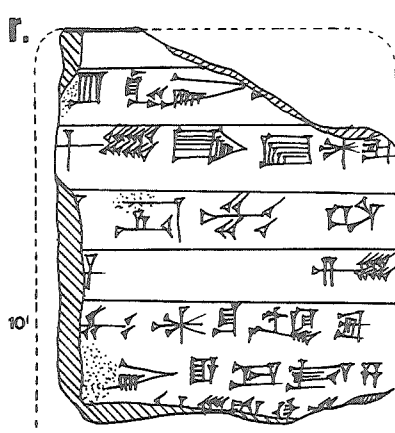
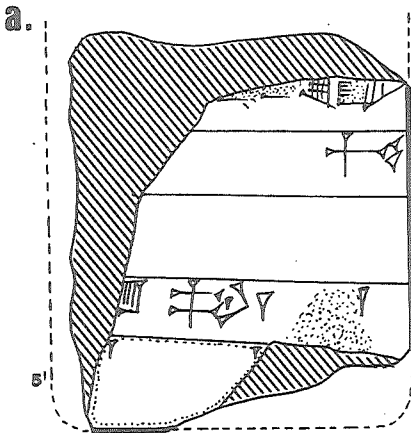

673 (MM 996)

Umma
Š35/vi/-

Reverso anepigráfico sellado

673. Sello:

Lugal-e₂-[mah-e]
dub-sar
dumu Lugal-ku₃-ga-[ni]

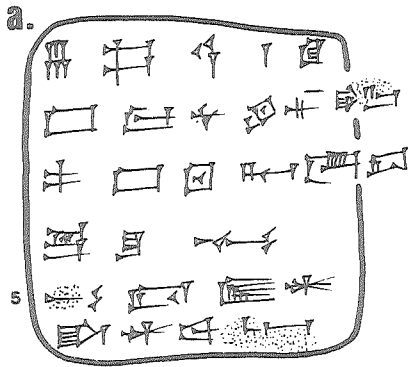

674 (MM 997)

Umma
AS5/[]

674. Sello:

Ur-⁴Nin-[tu]
dub-sar
dumu Du₁₁-g[a]

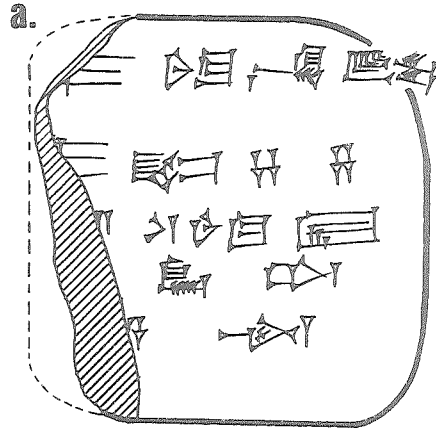

675 (MM 998)

Umma
AS2 6 3/[]

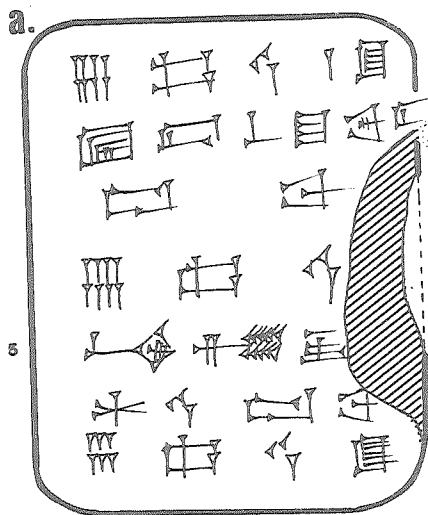

675. Sello:

E₂-AN[...]
dub-[sar]
dumu Inim-^d[...]

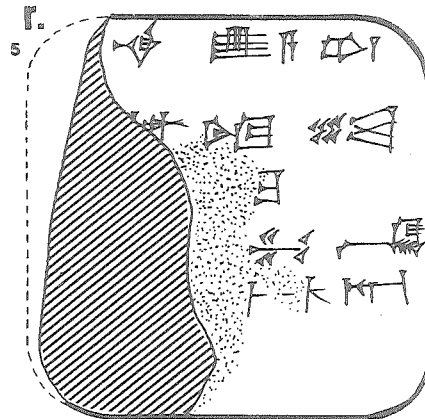

676 (MM 999)

Umma
ŠS17/-

676. Sello:

U₃-ma-ni
dub-sar
dumu Ur-⁶gigir

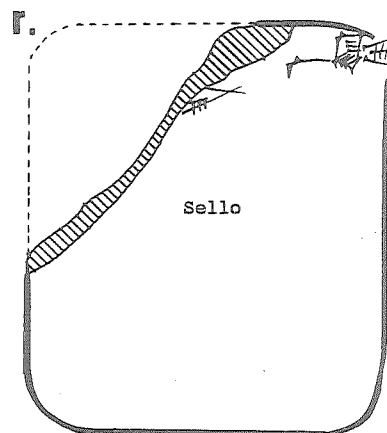
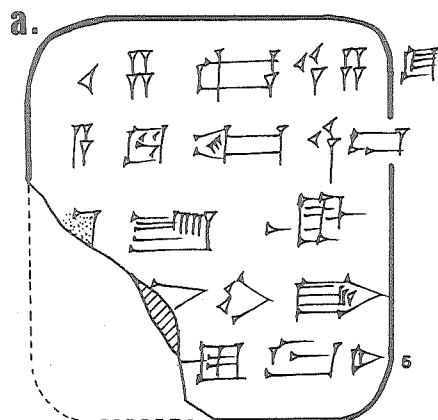

678 (MM 1001)

Umma
ŠS7/viii/-

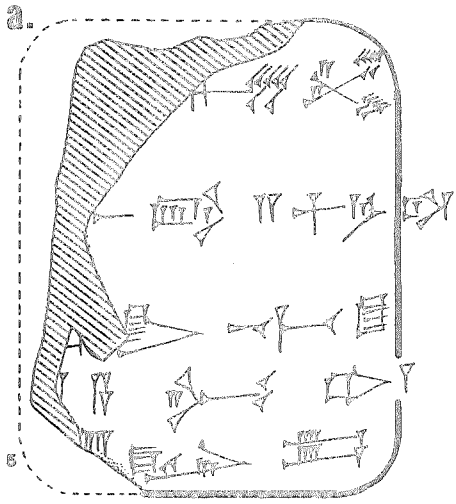

678. Sello:

Lugal-[nir]
dub-sar
dumu Ur-²[Šara₂]
ša₁₃-dub-ba-ka

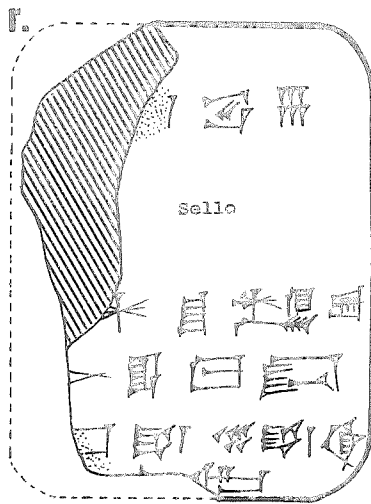

677 (MM 1000)

Umma
ŠS8/-/-

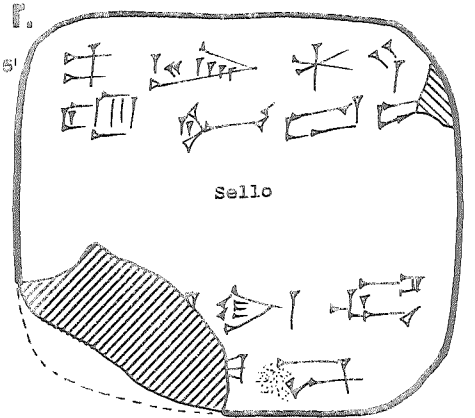
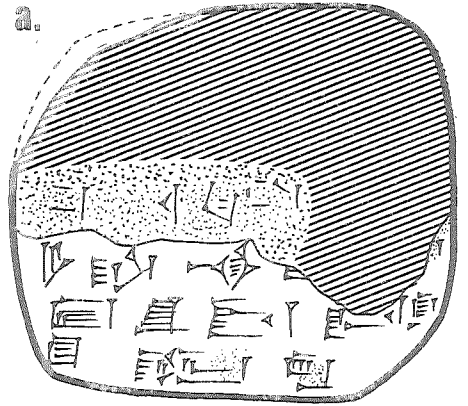

679 (MM 1002)

Umma
ŠS1/-/-

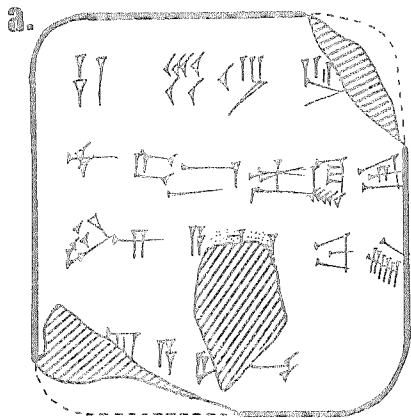

679. Sello:

A-gu
dub-sar
dumu Lugal-e₂-mah-²e

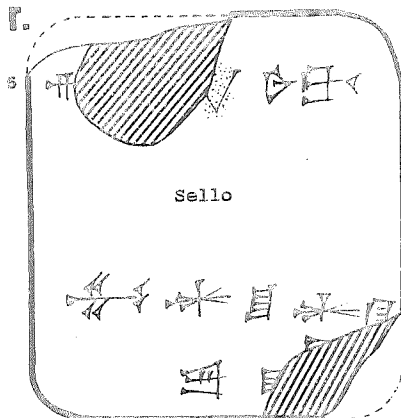

677. Sello:

- i ²Su-²Suen
lugal kal-ga
lugal Uri₂-²ma
lugal ²Ub-/da limmu₂-ba
- ii Gu-du-du
dub-sar
dumu Da-da-ga
arad₂-zu

680 (MM 1004)

Umma
AS3/-/- {v-vii}

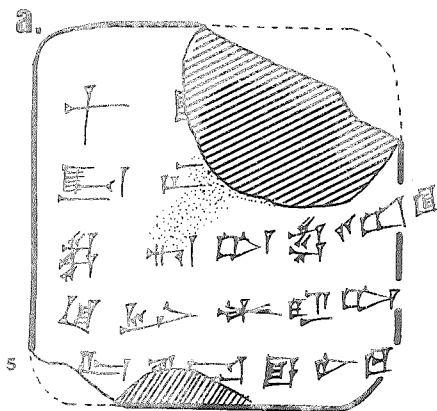

680. Sello:

Ur-²e₁₁-[e]
dub-[sar]
dumu Ur-²ni₉-[gar]

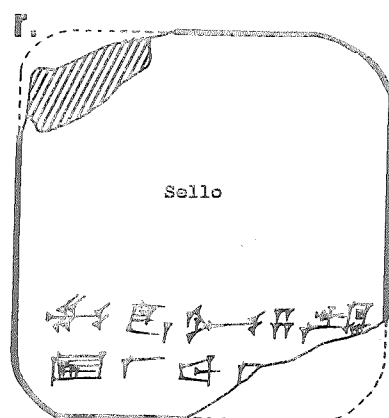

681 (MM 1005)

Lagaš
[]

Perdida aprox. media tablilla

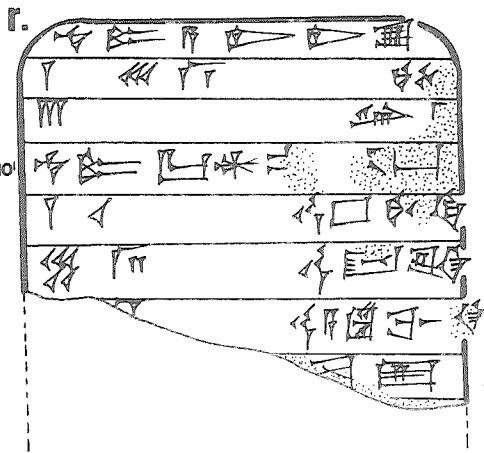
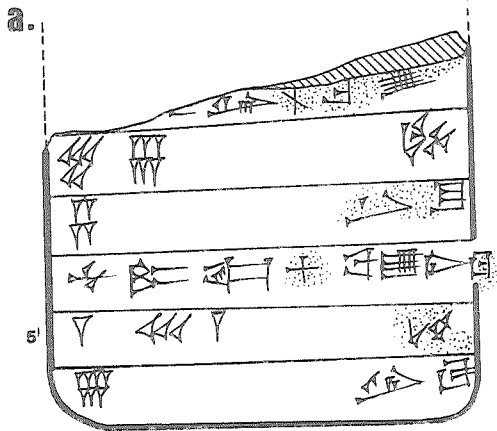

682 (MM 1006)

Umma
SS2'/-/-

682. Sello:

Šeš-kal-la
dub-sar
dumu Tir-gu

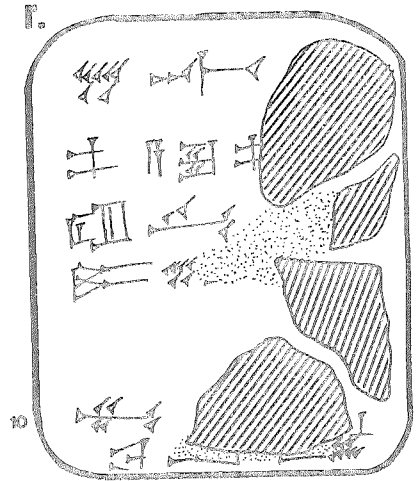
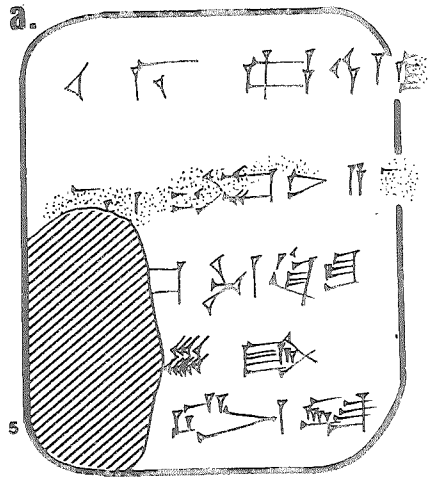

683 (MM 1008)

?
ASS/-/-

Perdido algo menos de media tablilla

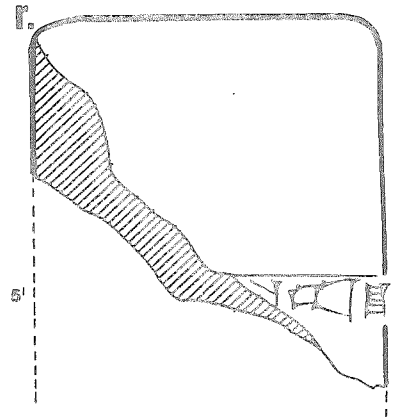
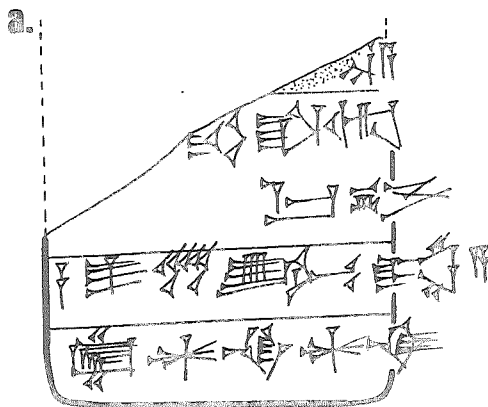

684 (MM 1009)

Umma
AS1/-/-

684. Sello:

Lu₂-kal-la
dub-sar
dumu Ur-e₁₁-[e] kuš,

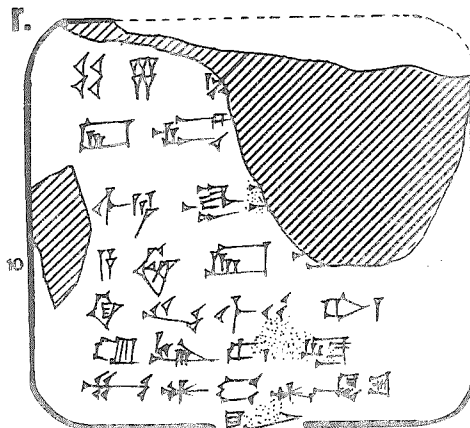
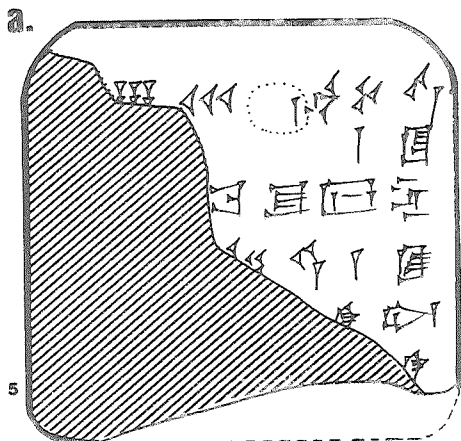

685 (MM 1010)

Umma
Š35/-/-

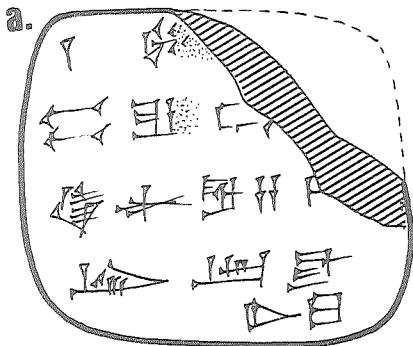

685. Sello ilegible



687 (MM 1050)

Umma?
Š46/-/-

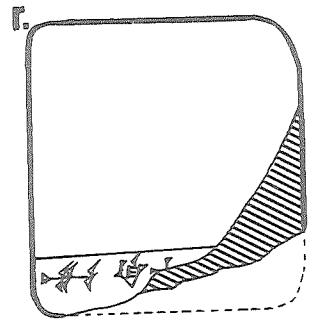
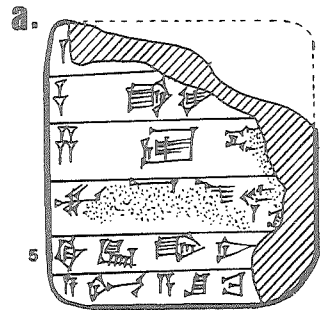

686 (MM 1011)

Umma
AS2/xiii/-

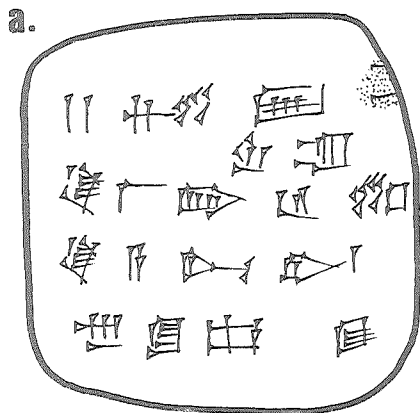

686. Sello:

Šara₂-za-me
arad Ša[ra₂]
ugula [kin₂-kin₂]

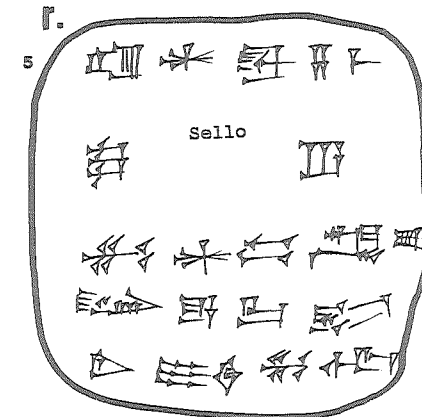

688 (MM 1052)

Drehem
[]/iv/20

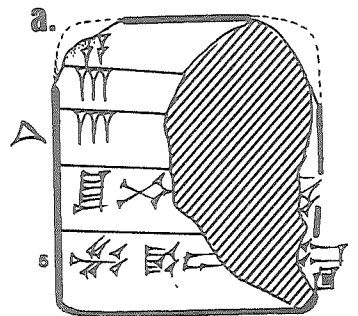

689 (MM 1053)

Umma
ŠS9/xii/[?]

Perdida aprox. media tablilla

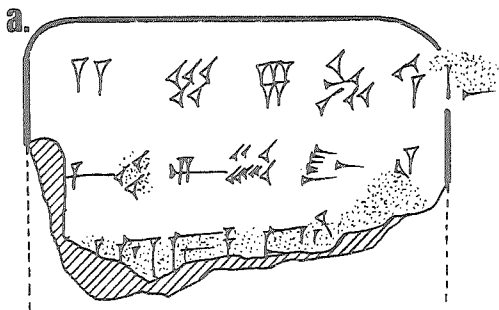

689. Sello:

Lu₂-Šakan₂
d[ub⁷...] [...]
dumu⁷ [...]

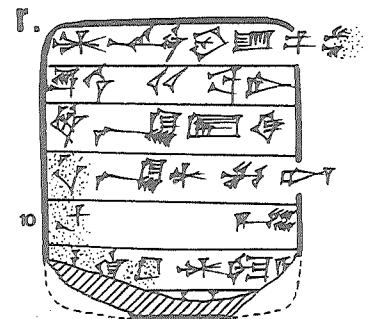
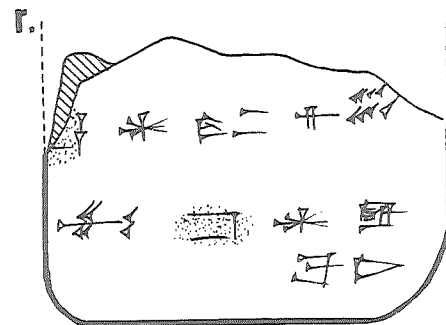

691 (MM 1056)

691. Sello ilegible

Umma
ŠS9/[]

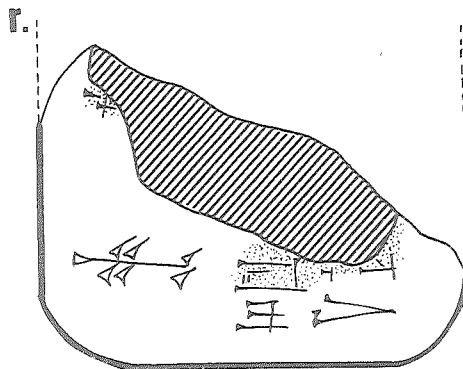
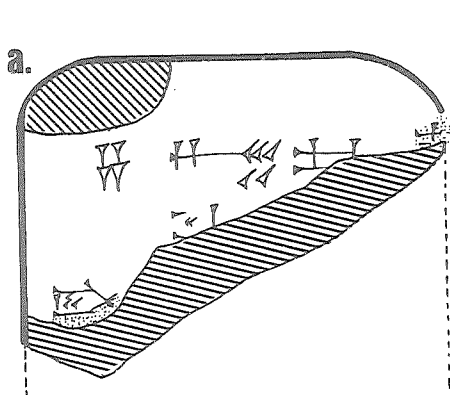

690 (MM 1054)

Umma
AS2 6 3/ii/20[(+x)]

692 (MM 1057)

692. Sello:

Umma'
AS1 ŠS1 6 IS1/[]

"Ad"-da-k[al-la]
nu-[banda₃ gu₄]
"dumu" [...]

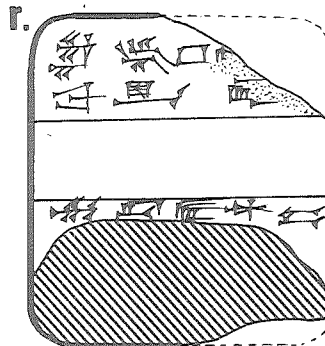
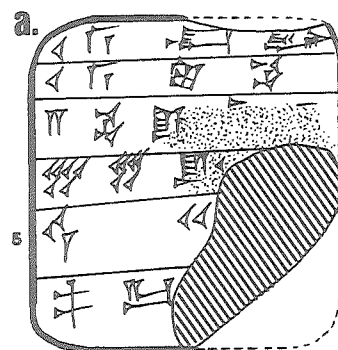
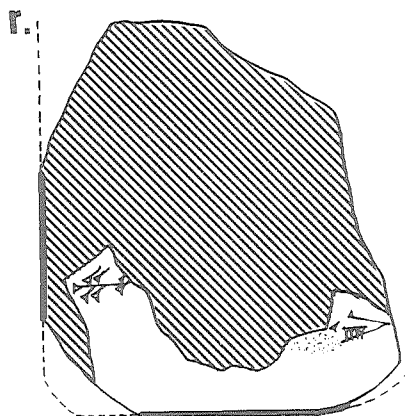
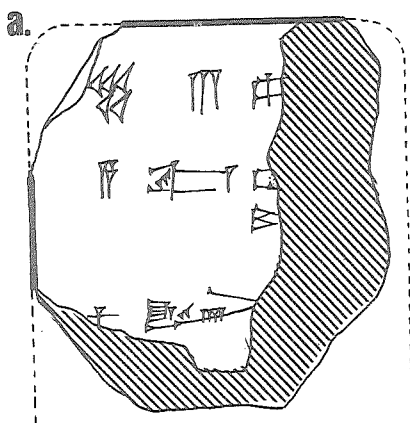

693 (MM 1058)

693. Sello:

Umma
[]/-/

"x" [...]
[...]

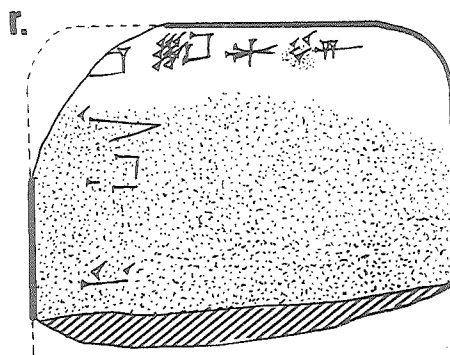
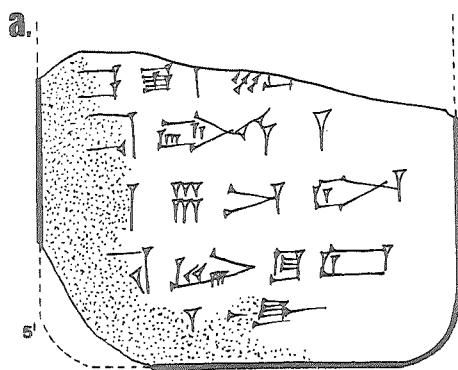

694 (MM 1060)

Umma
 ŠS2 6 8/-/-

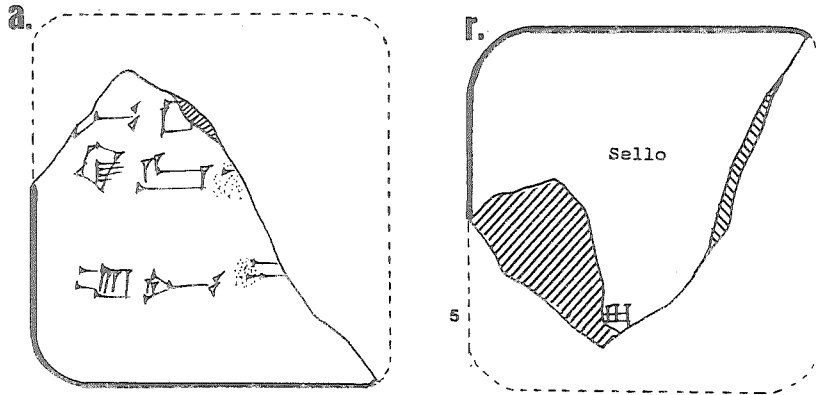

694. Sello:

- i Šu-Šuen
 lugal kal-ga
 lugal Uri₂/^{ki}-ma
 lugal Ub-/da limmu₂-ba
- ii Gu-du-du
 dub-sar
 dumu Da-[da-ga]
 arad₂-[zu]

695 (MM 1061)

?
 ŠS.../vi/[?]

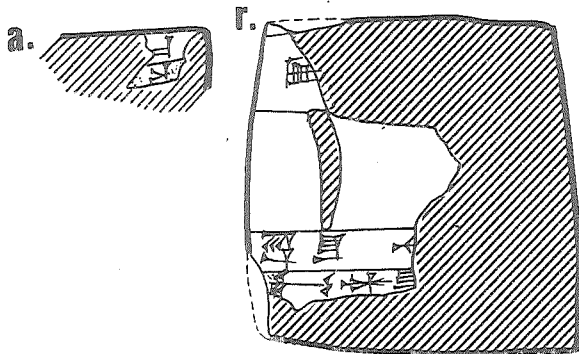

696 (MM 1062)

Umma
 Š39/[?]/-

696. Sello:

Ba-ša₆-ga
 dumu Giri₃-[ne₂]
 gal₂-[la₂-gal]

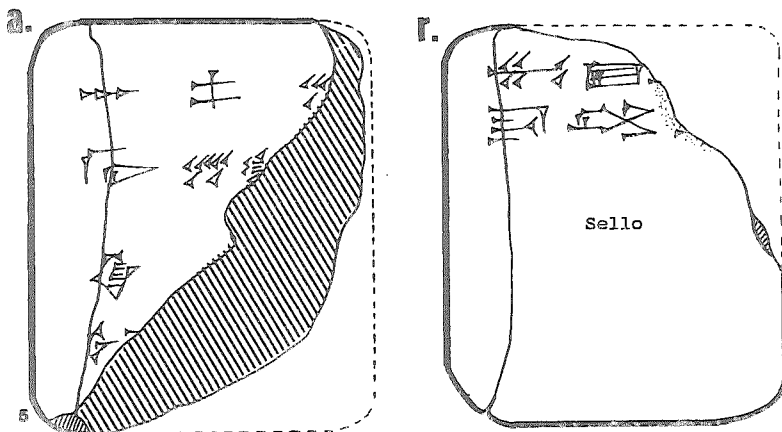

697 (MM 1064)

?
 []

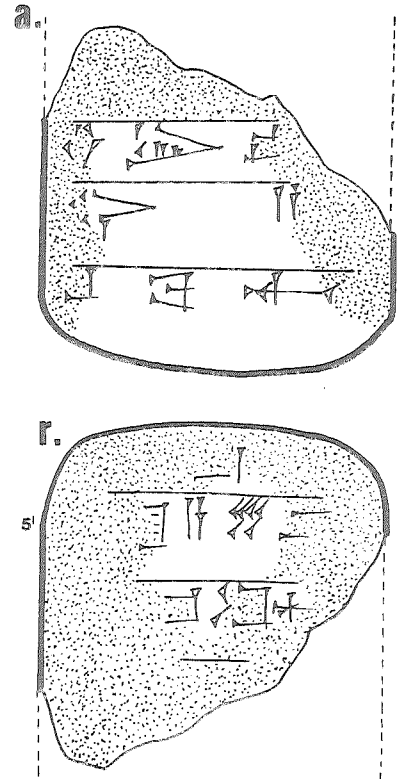

698 (MM 1065)

Umma
 []

698. Sello:

Da-a-gi
 dub-sar
 Línea en blanco

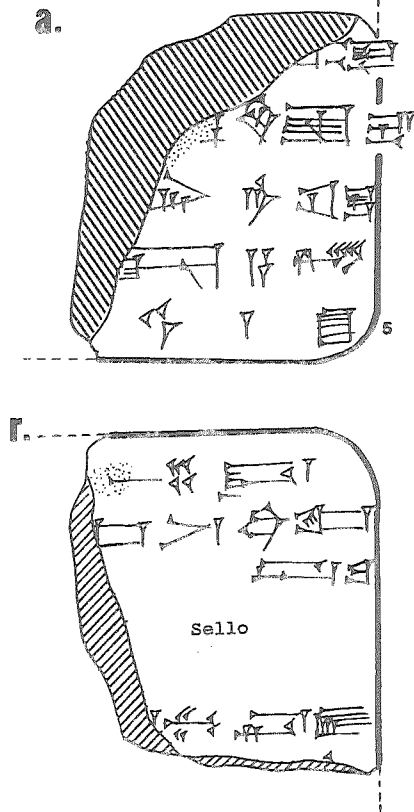

699 (MM 1066)

Umma
AS7/[]

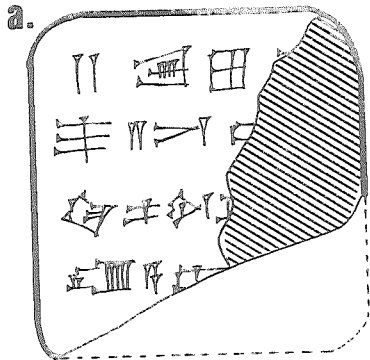

699. Sello:

A-kal-la
dumu Lu₂-bul[ug₃-ga₂]
ašgab [gal]

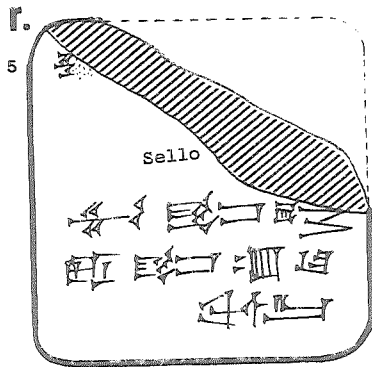

702 (MM 1070)

Umma
[]

Fragmento de una tablilla de gran tamaño

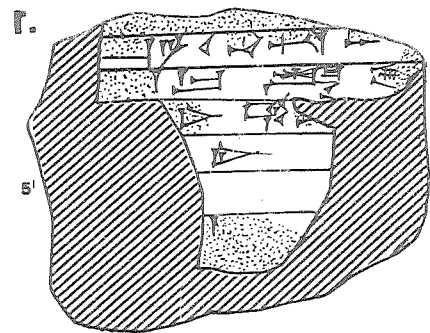
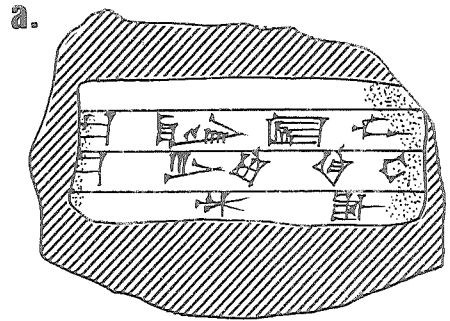

701 (MM 1068)

Umma
SS8/[]

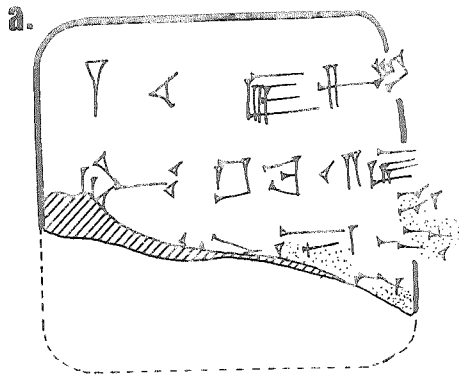

701. Sello:

A-gu
dub-[sar]
dumu Lugal-e₂-mah-e

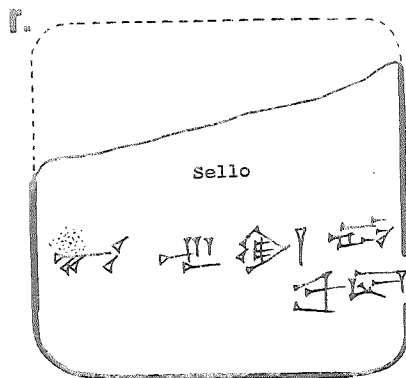

703 (MM 1074)

Umma
Š44 6 IS3/[]

703. Sello:

Ur-⁶Li₂-[si₄]
ensi₂ [Umma⁶²]
Ur-[...]
[dumu ...-g]i⁷
[arad₂-zu]

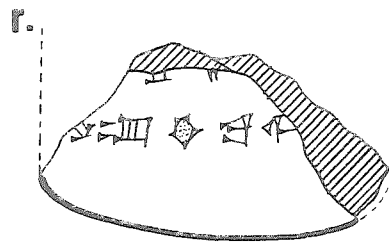
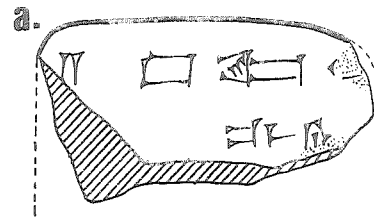

700 (MM 1067)

Umma
SS9/-/

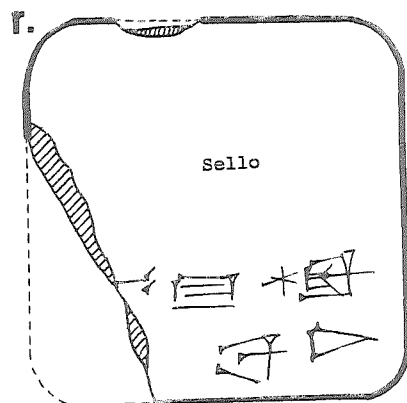
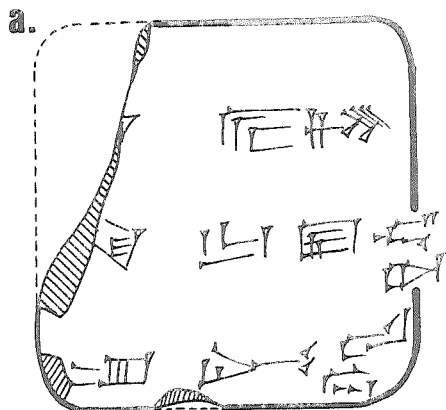

700. Sello:

i Šu-⁶Suen
lugal kal-ga
lugal Uri₂⁶²-ma
lugal ⁶Ub-/da limmu₂-ba
ii Gu-du-du
dub-sar
dumu Da-da-ga
arad₂-zu

704 (MM 1081)

Umma
ŠS9/xi/-

704. Sello:

ʾAʾ-[lu₂-[lu₂]
dumu Inim-Šara₂
kurušda Šara₂-ka

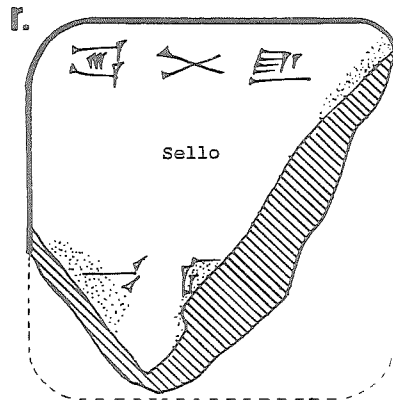
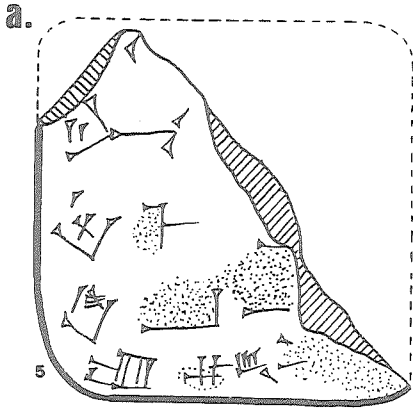

707 (MM 1085)

Umma
AS4/-/-

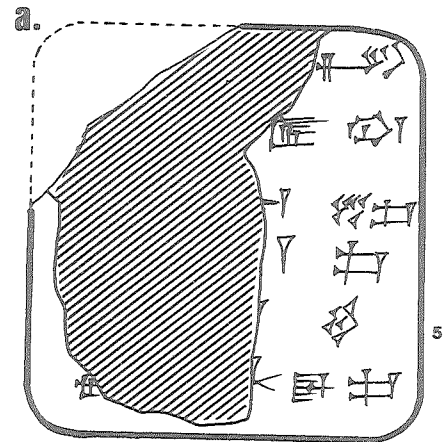

705 (MM 1083)

Umma
AS5ʾ/-/-

705. Sello:

A-kal-la
dub-sar
dumu Ur-ni₉-[gar kuš,]

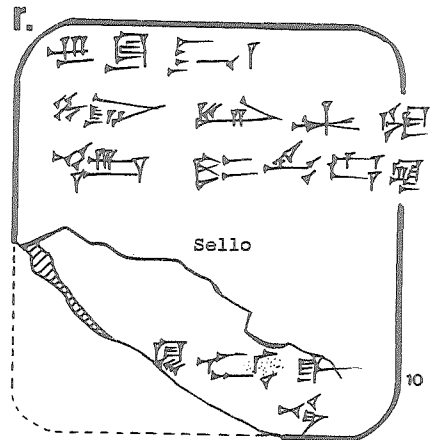
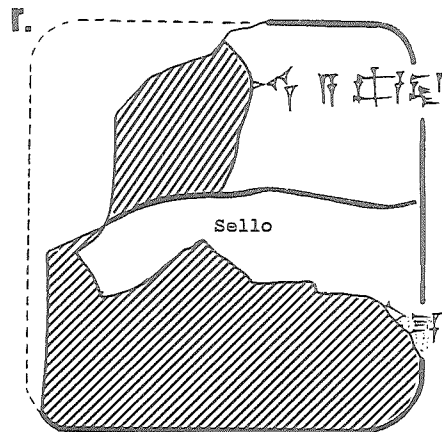
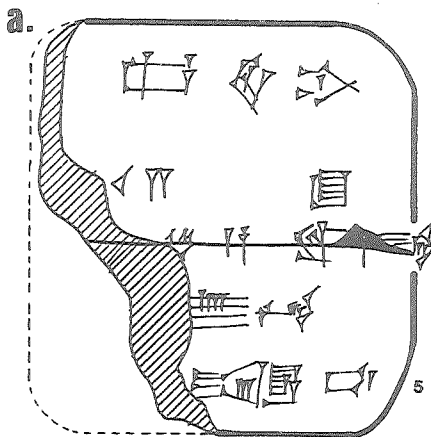

706 (MM 1084)

Umma
[]

706. Sello:

ʾUrʾ-e₁₁-[e]
dub-[sar]
dumu Ur-ni₉-g[ar]

707. Sello:

Lu₂-d^r-Dumuʾ-ziʾ-[-[daʾ]
dub-sar
dumu Ur-d^r-Ninʾ-šuburʾ

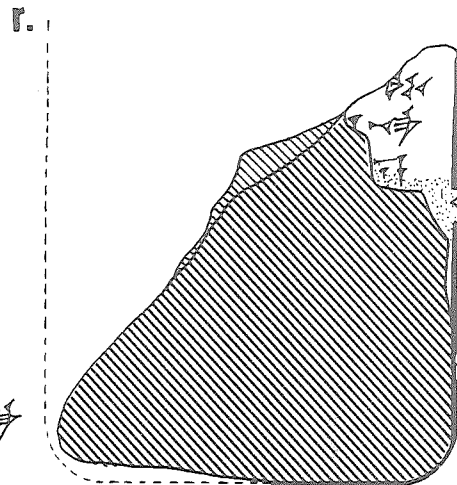
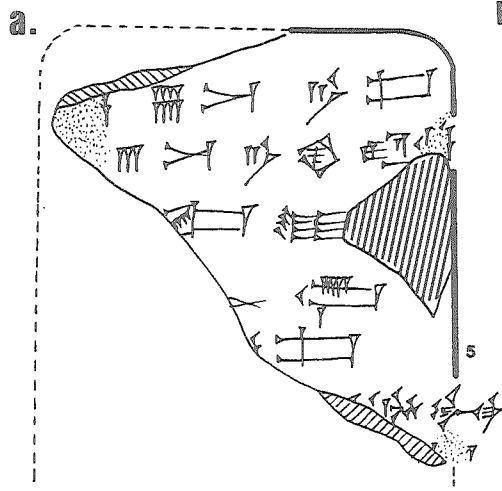

708 (MM 1086)

Umma
ŠS3/[]

708. Sello:

A-gu
dub-sar
dumu Lugal-e₂-m[ah-e]

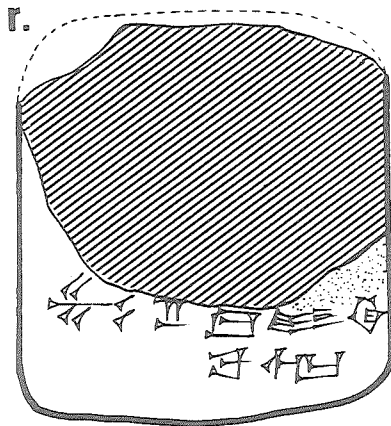
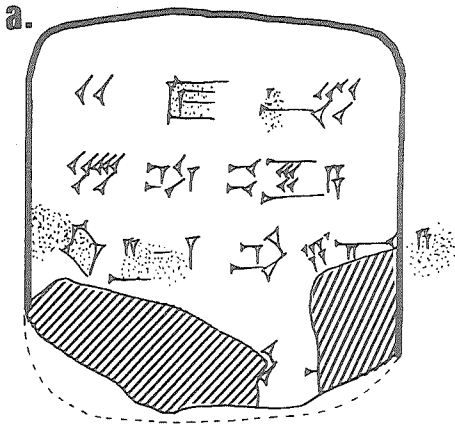

709 (MM 1087)

?
[]

Anverso¹ destruido

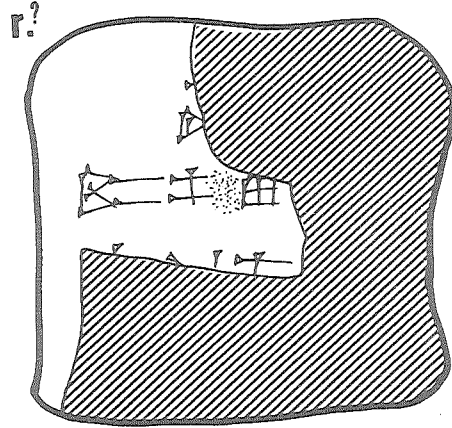

709. Sello:

[...] DU [...]
arad₂ [...]

710 (MM 1092)

?
AS1/[]

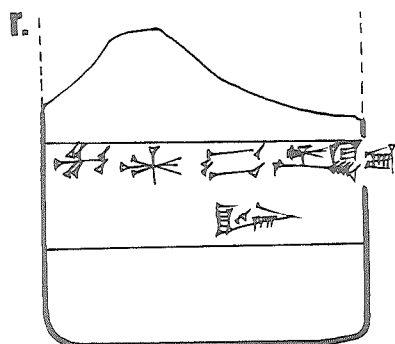
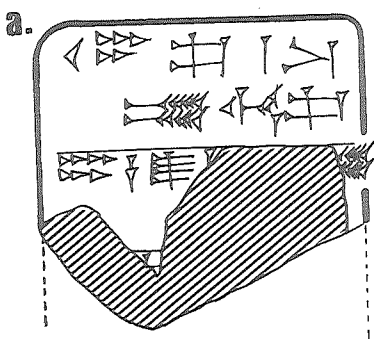

712 (MM 1097)

Umma
[]

712. Sello:

Ur-gigir
dub-sar
[dumu Bar-ra-a]n

Reverso anepigráfico sellado y parte inferior destruida

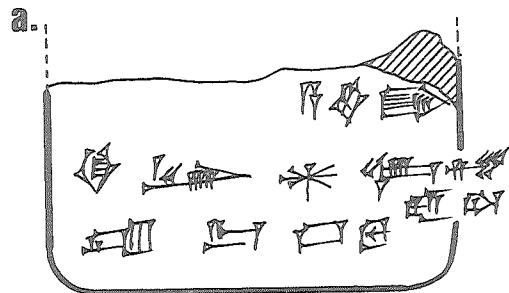

711 (MM 1093)

?
[]

Perdida aprox. media tablilla

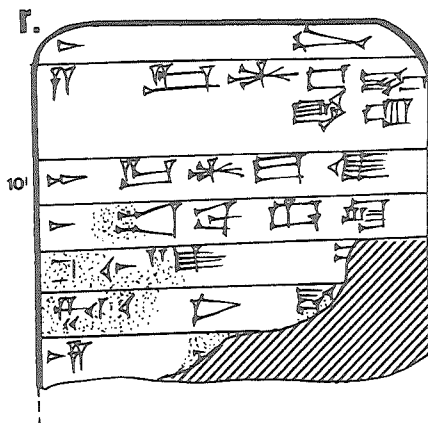
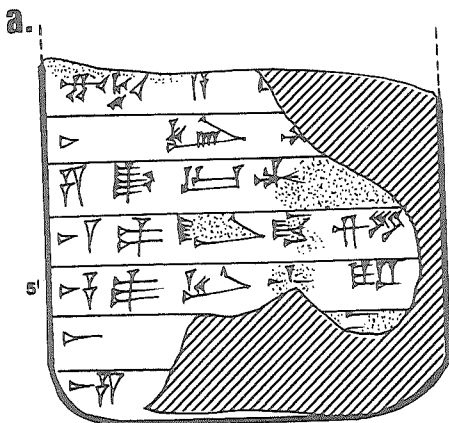

713 (MM 1099)

713. Sello ilegible

?
Š33/[]

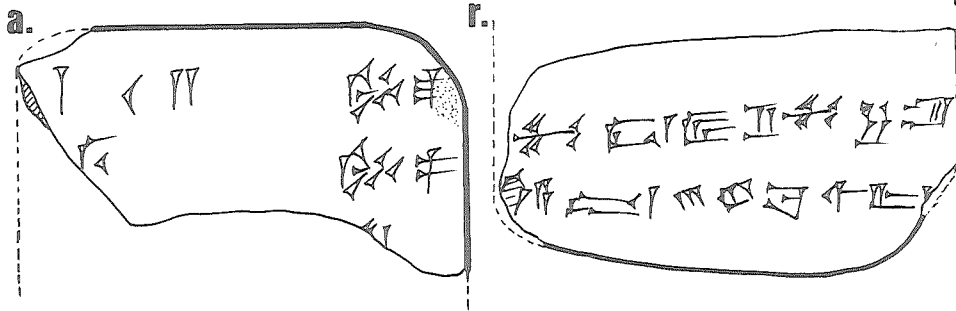

716 (MM 1104)

Drehem
ŠS9/ii 6 iv/[?]

Perdido aprox. mitad inferior e izquierda de la tablilla

714 (MM 1100)

714. Sello:

Umma
AS9/[]

Da-a-ga
dub-sar
dumu Ur-giš-ša₃-ga

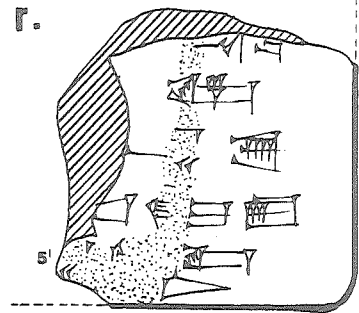
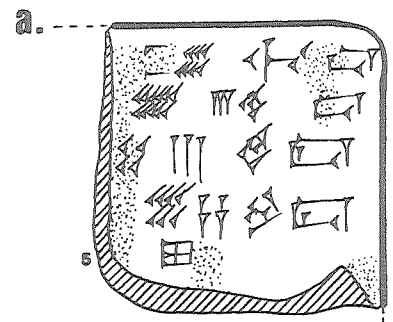
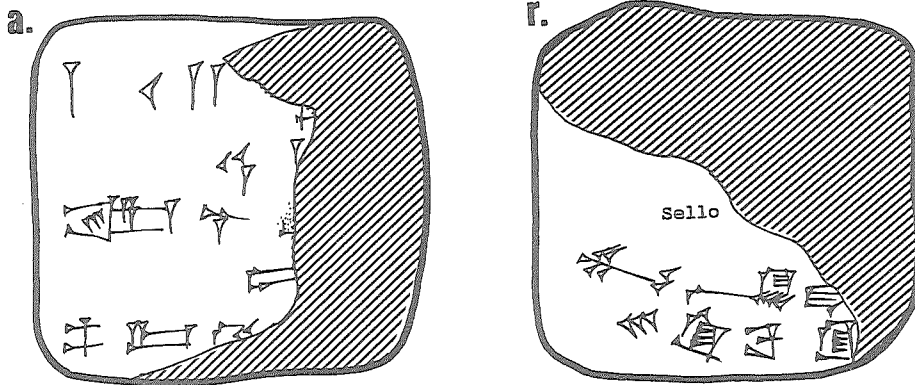

715 (MM 1103)

715. Sello:

Drehem
AS8/iv 6 v/[]

Ad-da-kal-¹la²
dub-[sar]
dumu Nig₂-erim₂[...]

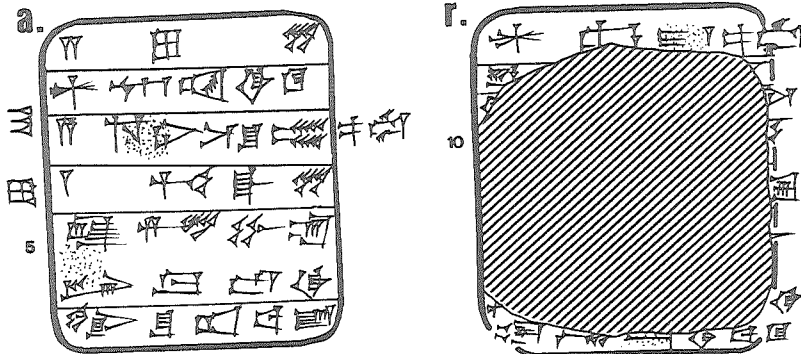

716. Sello:

Šu-⁴Suen⁷
lugal kal-ga
lugal Uri⁵-ma
lugal ⁶Ub-da limmu₂-ba
Ur-⁴Sul-pa-e₃
dub-[sar]
dumu Ur-⁴Ha-[ia₃]
[arad₂-zu]

717 (MM 1105)

Tablilla demasiado destruida para copia
Se conserva: [... U]r-⁴Gu-nu-[ra] / [... D]U

718 (MM 1106)

?
Š41/[]

718. Sello:

[...] dub-[sar] [...]

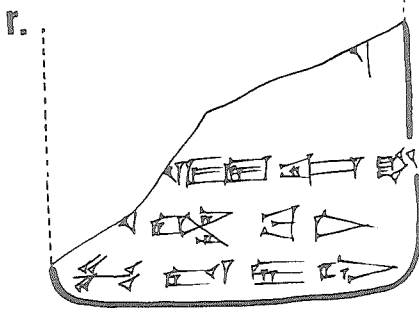
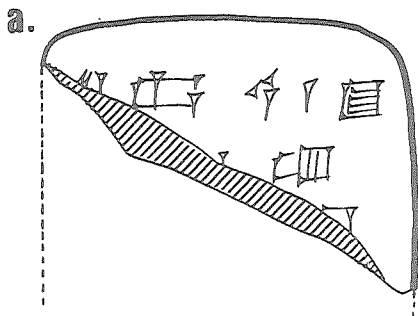

719 (MM 1107)

Umma
[]

Reverso destruido

719. Sello ilegible

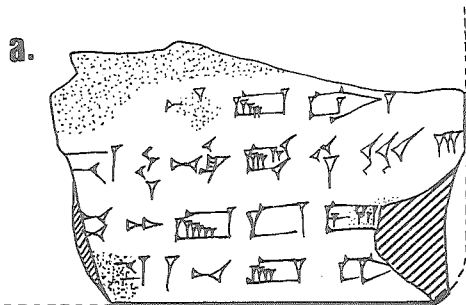

721 (MM 1109)

Tablilla demasiado destruida para copia

722 (MM 1110)

Umma
[]

722. Sello:

˘Lugal˘-[e, mah-e]
dub-sar
dumu Lugal-[ku,]-ga-ni

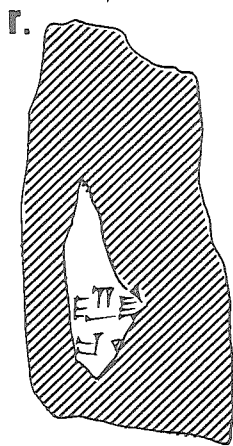
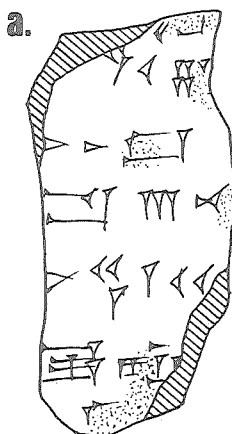

720 (MM 1108)

Umma
[]

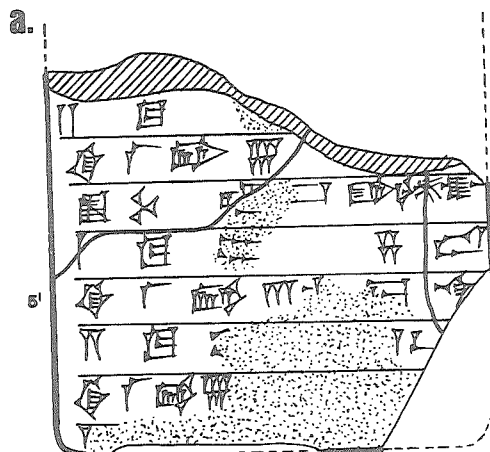

723 (MM 1111)

Umma
AS3/xi/-

723. Sello:

Lugal-e, ˘mah-e˘
dub-sar
dumu Lugal-ku, ga-ni

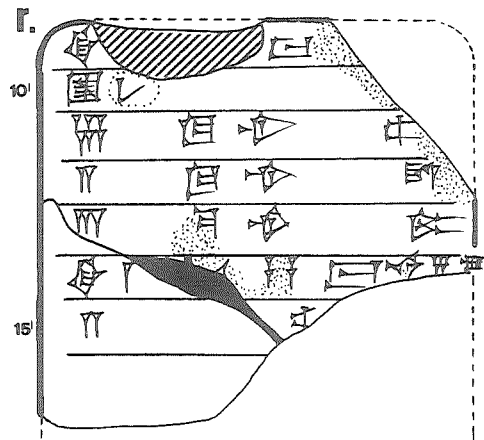
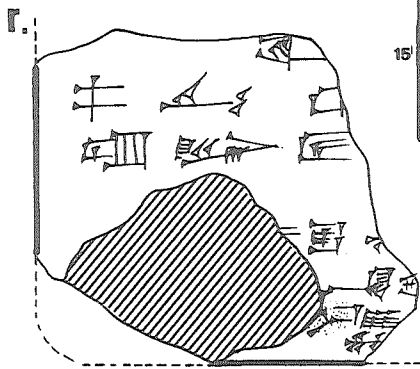
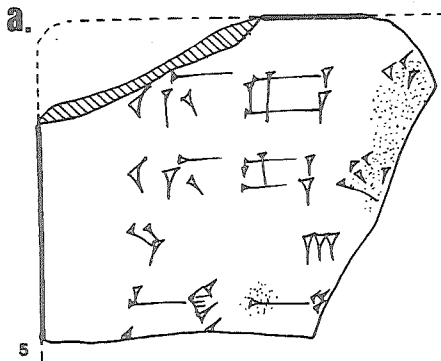

724 (MM 1112)

Umma
[]

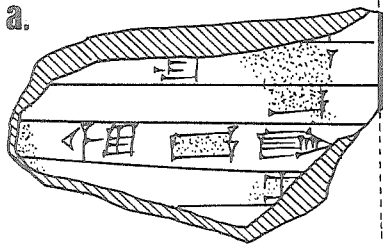

724. Sello ilegible

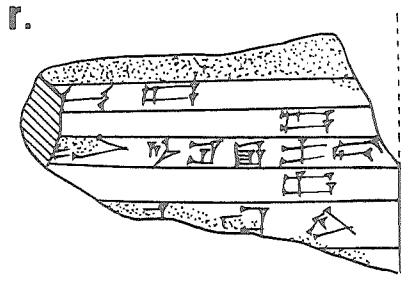

727 (MM 1117)

?
[]

Reverso destruido

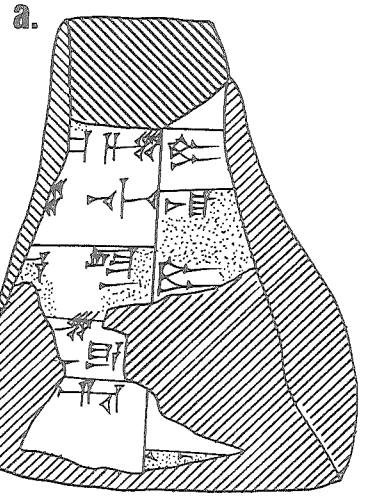

725 (MM 1113)

Umma
Š32 33 44 45 AS6 6 7/iv/[?]

725. Sello ilegible

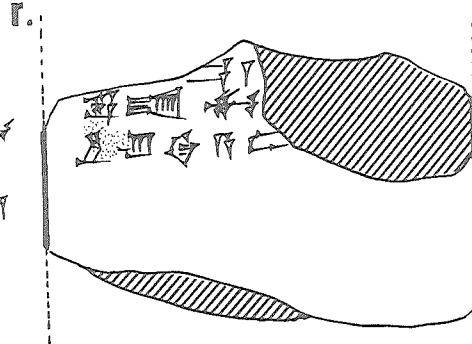
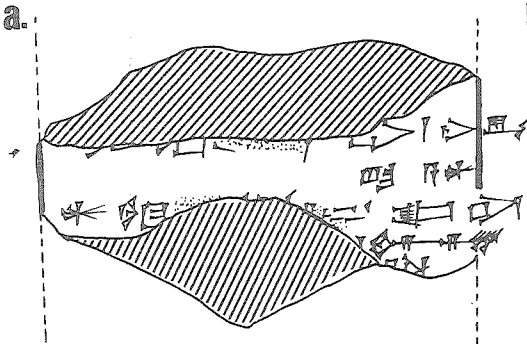

728 (MM 1118)

Umma
AS4 ŠS6 6 8/-/

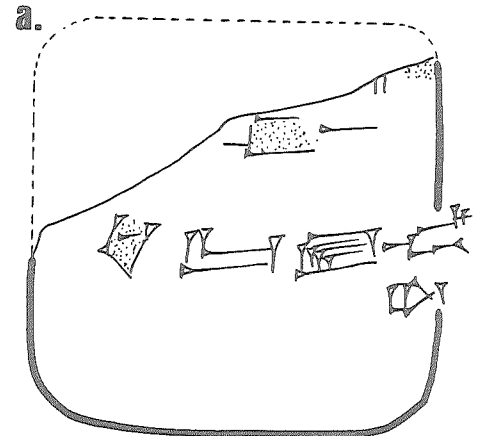

726 (MM 1116)

Umma
-/-

726. Sello:

Lugal-[e-ba]-an-[ša₆]
dub-sar
[dumu] Ur-⁴Iš[taran]

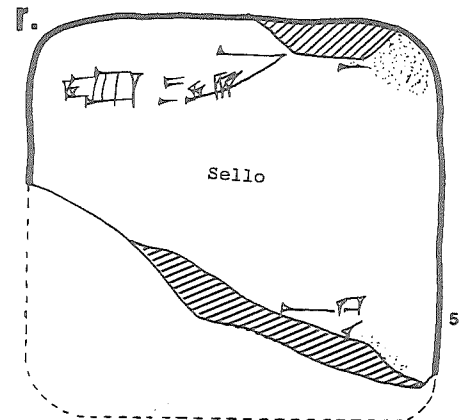
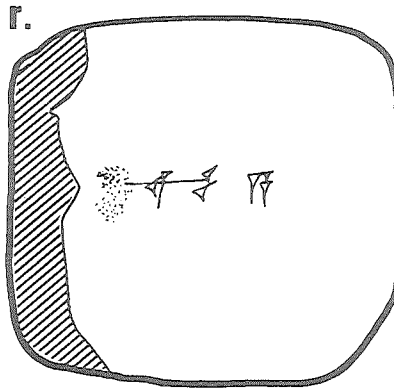
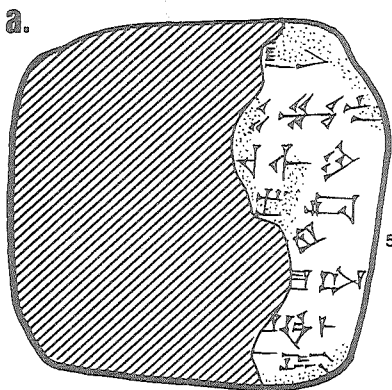

729 (MM 1119)

Umma
AS4/vi/[?]

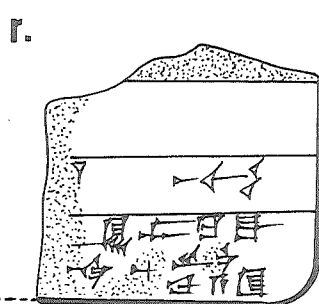
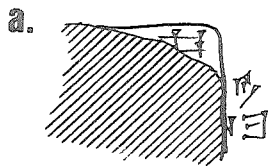

728. Sello:

Lugal-⁷nir⁷
dub-sar
dumu [Ur-⁴Šara₂]
ša₃-dub-ba-ka

730 (MM 1120)

Umma
AS9/-/

730. Sello:

Ur-^d[Šara₂]
[dub-sar] dumu Tab-ša₃-[u₃¹-lu]

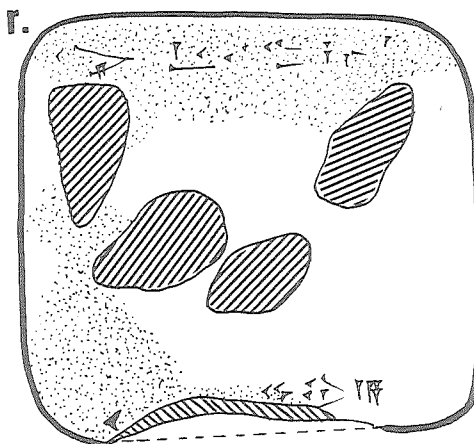
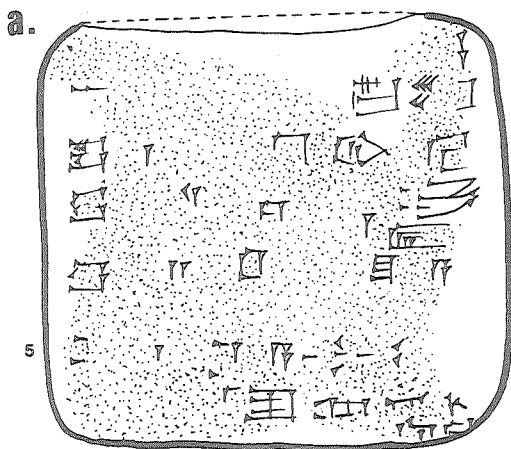

733 (MM 1123)

Umma
[]/6

731 (MM 1121)

Umma
[]

731. Sello:

Šeš-k[al-la]
dub-[sar]
dumu Lugal-ma₂-[gur₃-re]

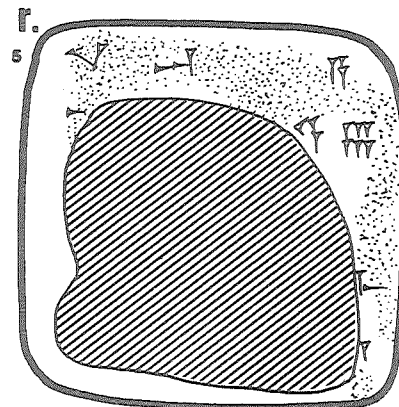
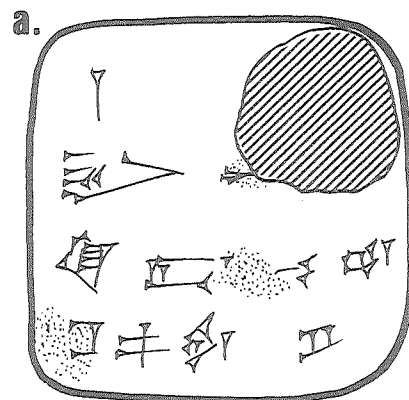
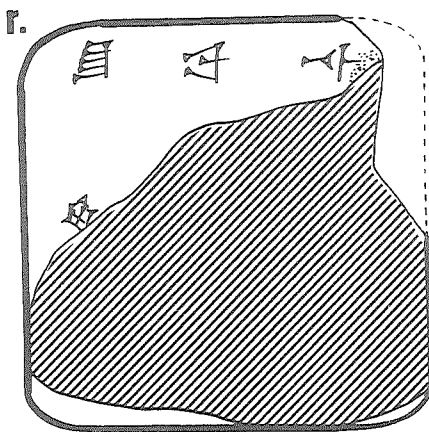
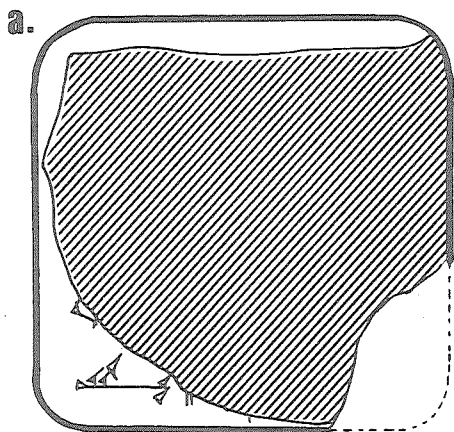

732 (MM 1122)

Lagaš^r
[]

732. Sello:

Ur-^dNin-mug-g[a]
dumu Ur-[-...]

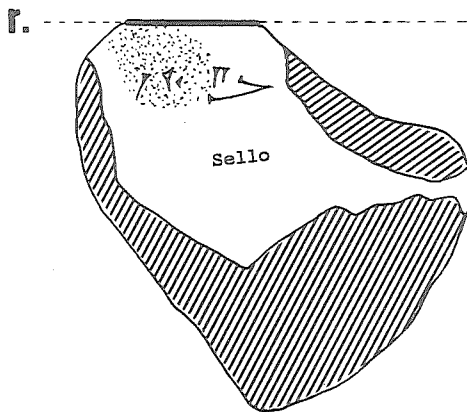
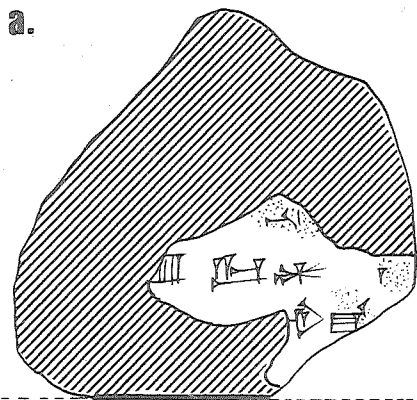

733. Sello:

- i [d'Amar]-[d'Suen]
lugal kal-ga
lugal Uri₂/ki-ma
lugal d'Ub-da /limmu₂-ba
- ii [A-kal-la]
[ensi₂]
[Umma^{bi}]
[arad₂-zu]

734 (MM 1124)

?
[]

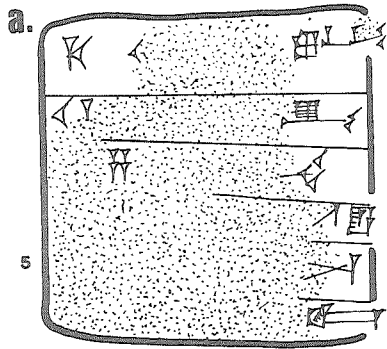

Reverso destruido en borde superior y parte inferior anepigráfica

735 (MM 1125)

Umma
ŠŠ1/ix/-

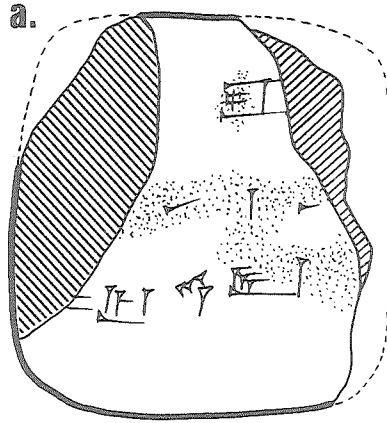

735. Sello ilegible

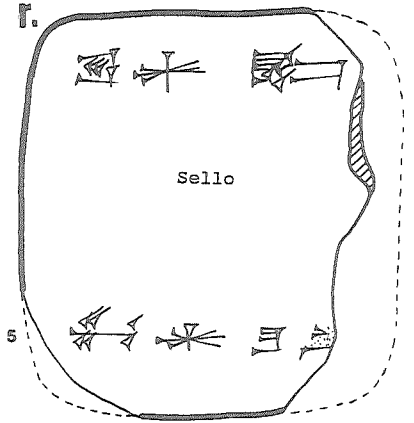

736 (MM 1126)

?
[]

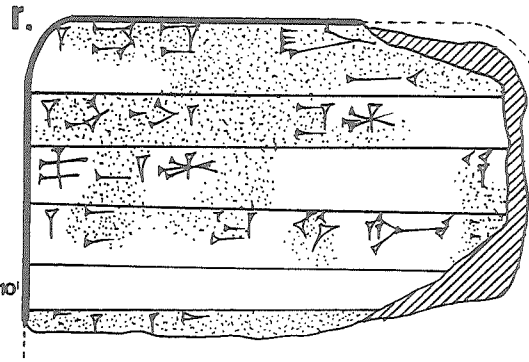
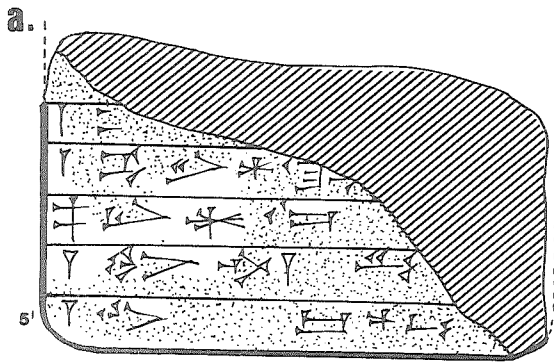

737 (MM 1128)

?
[]

737. Sello ilegible

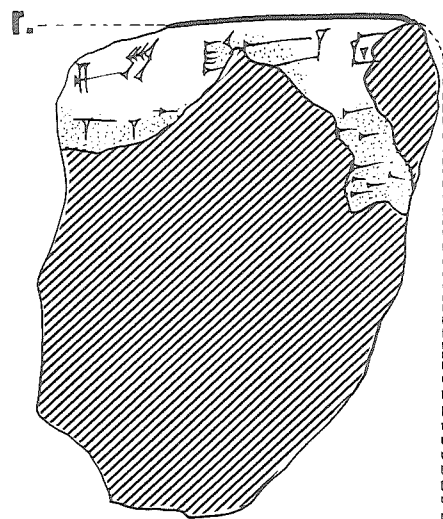
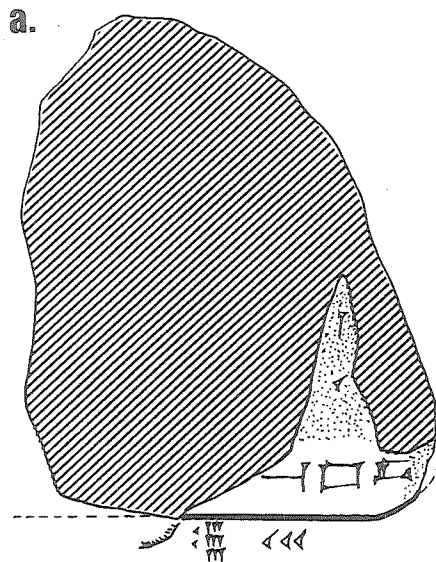

738 (MM 1129)

738. Sello ilegible

Tablilla demasiado destruida para copia

740 (MM 1136)

Umma
[]

739 (MM 1130)

Umma
š37/[]

739. Sello:

~Lugal-e₂-ma[h-e]
[d]ub-sa[r]
[dumu Lu]gal-ku₃-ga-[ni]

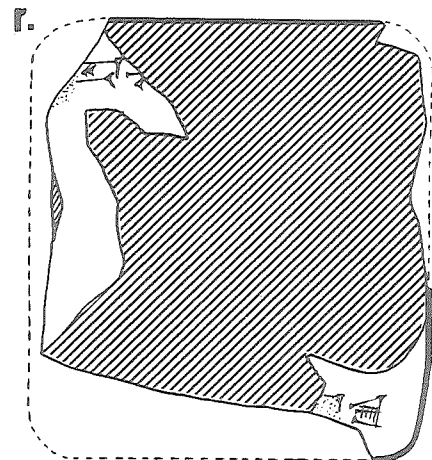
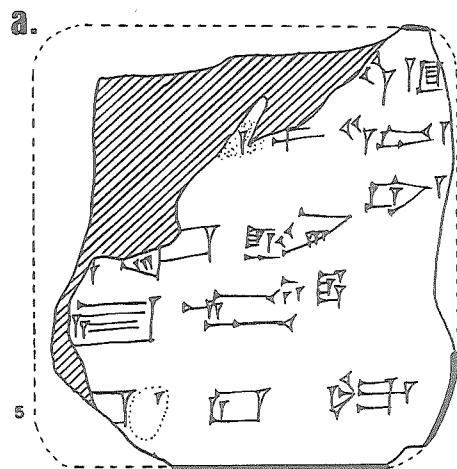
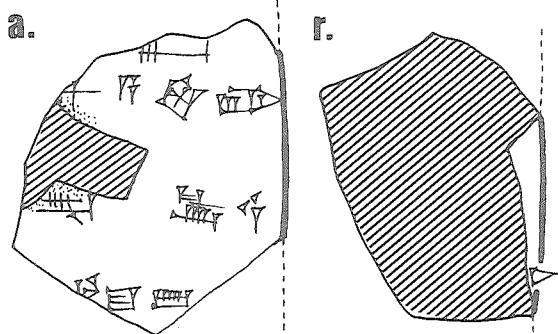

740. Sello:

Lugal-e₂-[mah-e]
dub-s[ar]
dumu Inim-^d[Šara₂]
sa₁₂-du₅-ka

742 (MM 1139)

Lagaš
[]

Fragmento de una tablilla de gran tamaño y varias columnas

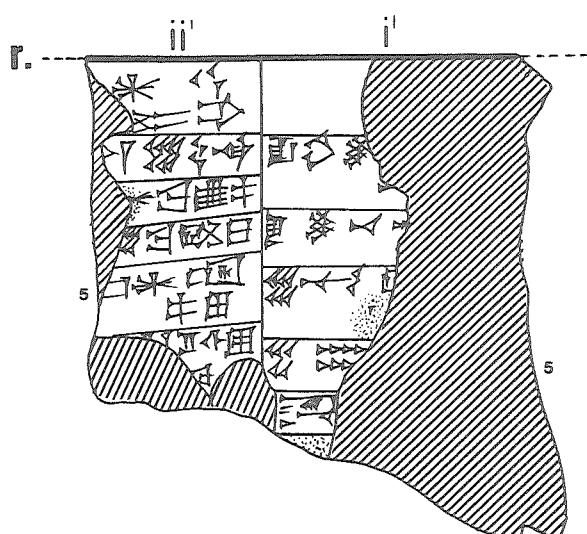
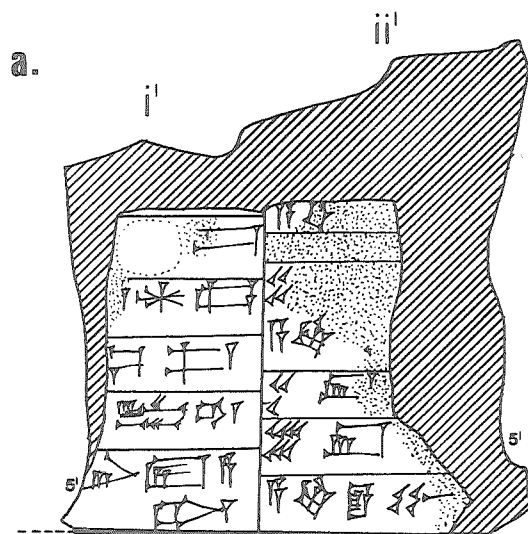

741 (MM 1137)

Umma
 ŠS8/ix/-

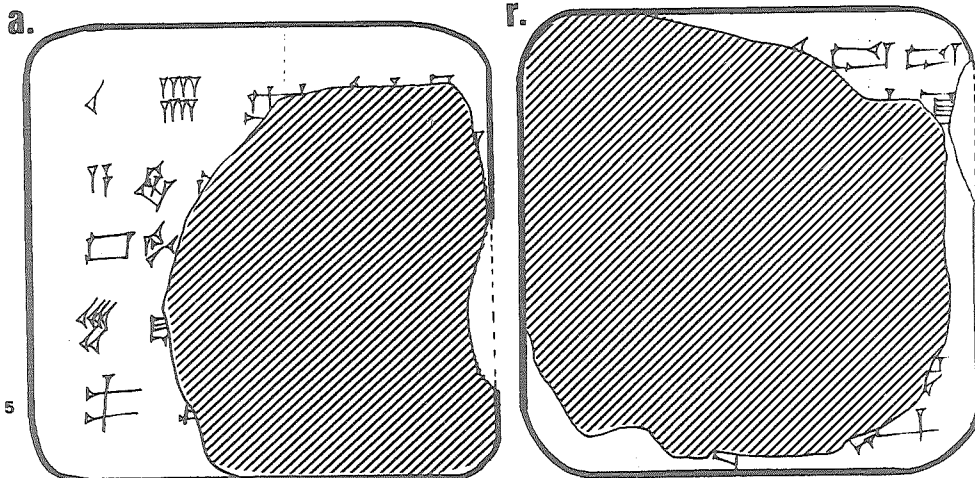

741. Sello:

- i Šu^d-Suen
 lugal kal-ga
 lugal Uri²-ma
 lugal Ub^d/da limmu₂-ba
- ii Gu-du-du
 dub-sar
 dumu Da-da-ga
 arad₂-[zu]

743 (MM 1141)

Umma
 ŠS8/viii/-

743. Sello:

[Lugal-he₂-gal₂]
 dub-[sar]
 dumu Ur-^d[Utu]

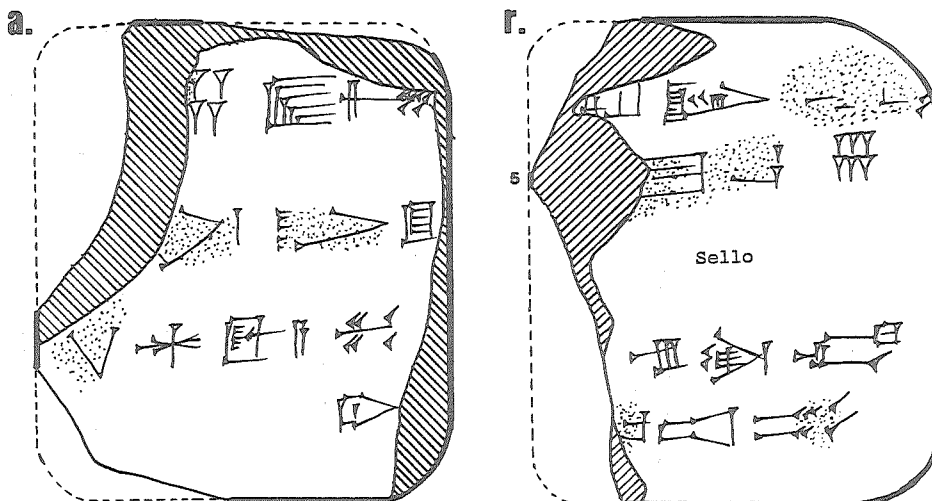

744 (MM 1142)

Umma
 ŠS4/xii/-

744. Sello:

Lu₂-kal-[la]
 dub-sar
 dumu Ur-e₁₁-e [kuš₇]

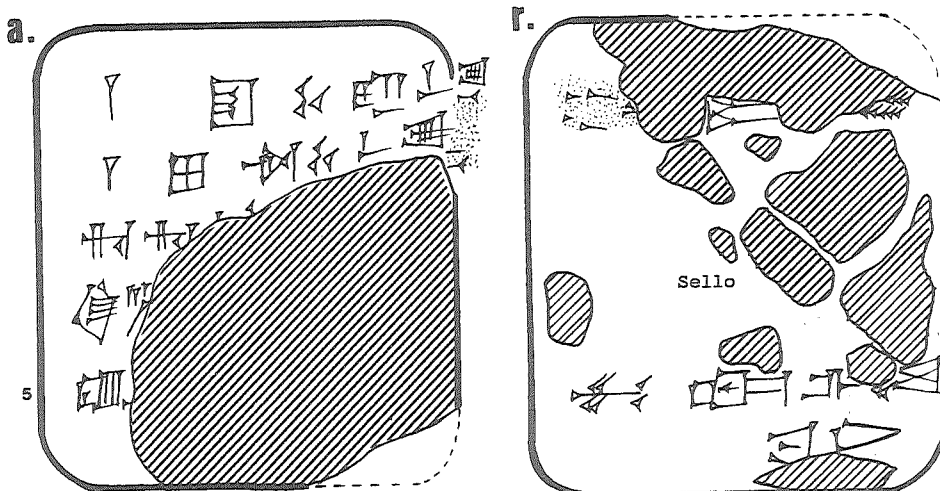

745 (MM 1143)

Umma
[]

Reverso destruido

745. Sello:

A-li₂-ni-K[U]
dumu Lu₂'- [...]

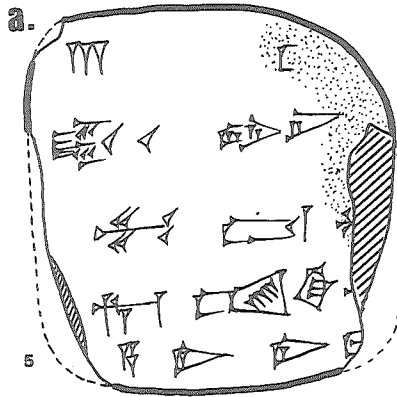

746 (MM 1144)

?
AS8/-

Anverso destruido

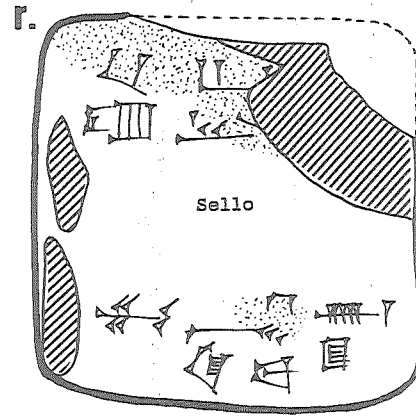

746. Sello ilegible

747 (MM 1146)

Umma
ŠS6/[]

747. Sello:

En-kaš₄'
dub-sar
dumu Ur-Šīšaran

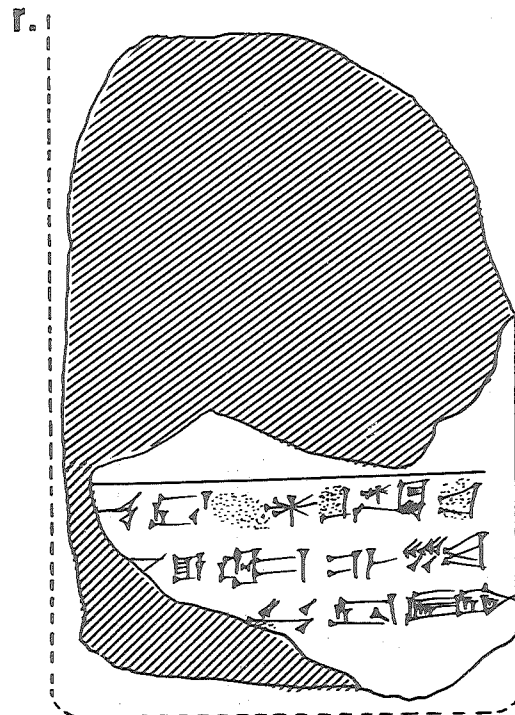
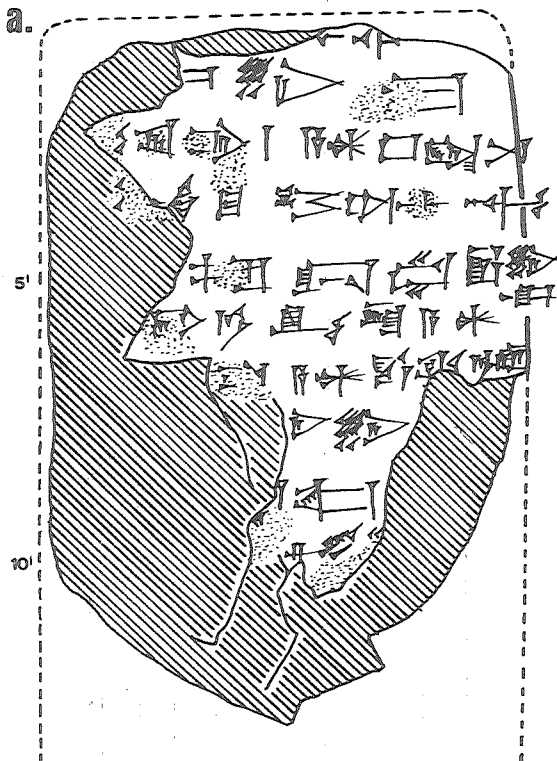

748 (MM 1149)

Umma
ŠŠ8/-/-

748. Sello:

Ur-[...]
dub-[sar]
dumu A-[...]

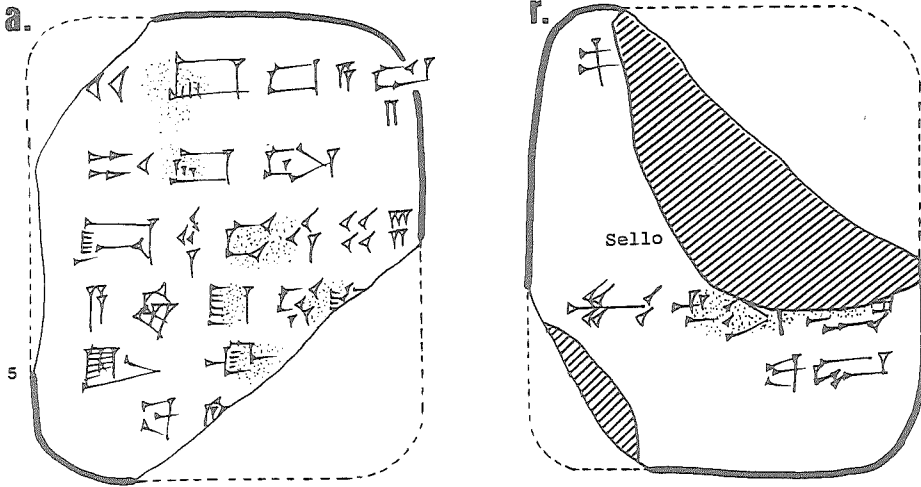

751 (MM 1155)

Lagaš⁷
[]

Reverso destruido

749 (MM 1151) a.

Umma
[]

Reverso destruido

749. Sello:

Nin-me-[lam₂]
dam Ur-^dL[i₃-si₄]
en[si₂]
Um[ma^{ki}]

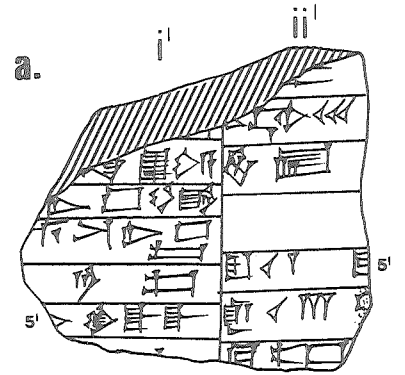
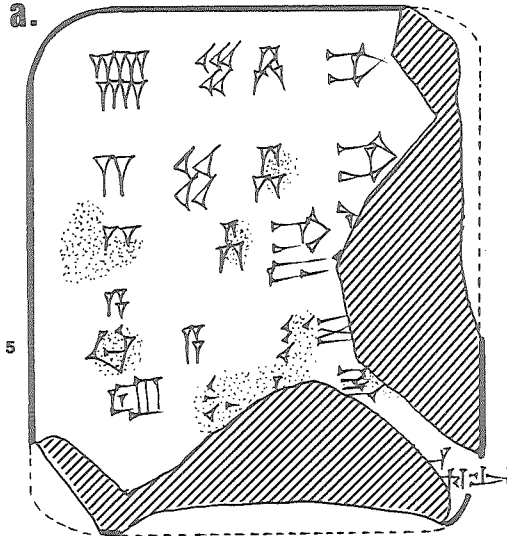

752 (MM 1156)

Lagaš⁷
[]

Fragmento de tablilla originalmente con
dos o más columnas por cada cara

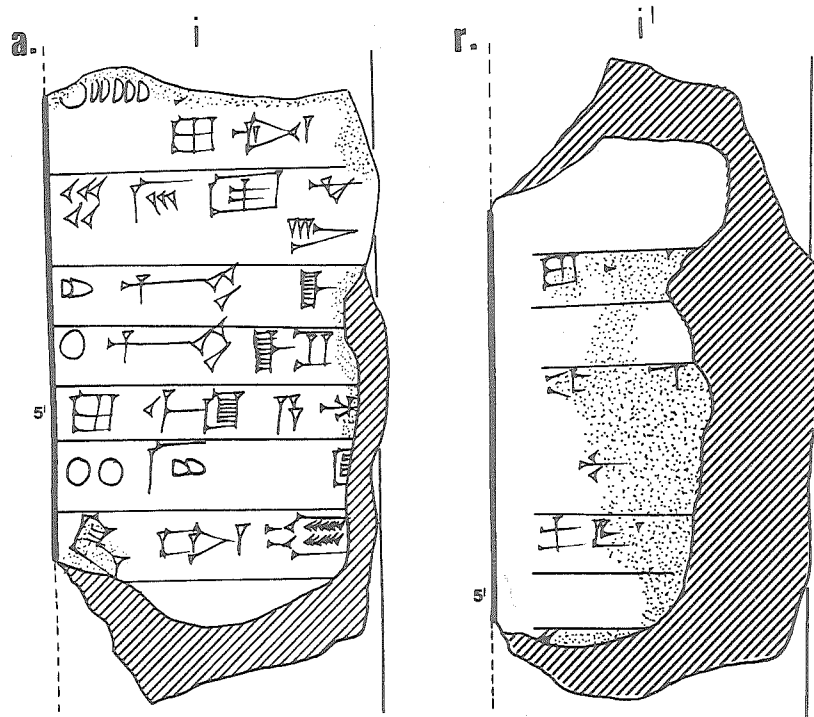

750 (MM 1152)

Umma
Š36/i/-

750. Sello:

Unken-ne₂
dub-sar
dumu Ur-^{si}gi[gir]

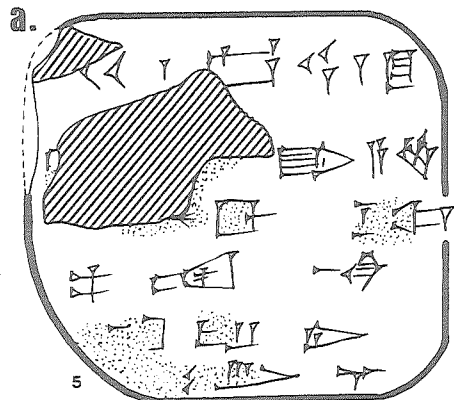

755 (MM 1159)

?
[]

Reverso destruido

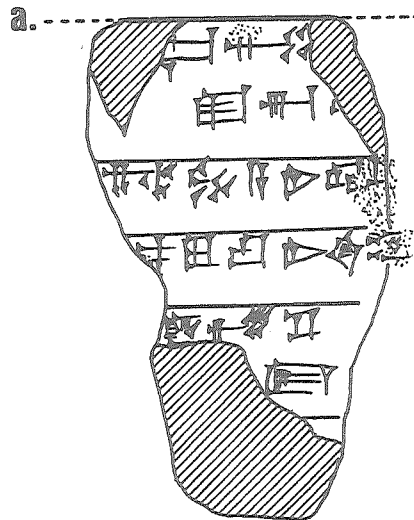

753 (MM 1157)

34 pequeños fragmentos con restos de impronta de sello

754 (MM 1158)

40 pequeños fragmentos sin impronta de sello

756 (MM 1160)

Umma
ŠS2 6 8/viii/-

756. Sello:

A-kal-[la]
dumu Lu₂-[bulug₃-ga₂]
ašgab [gal]

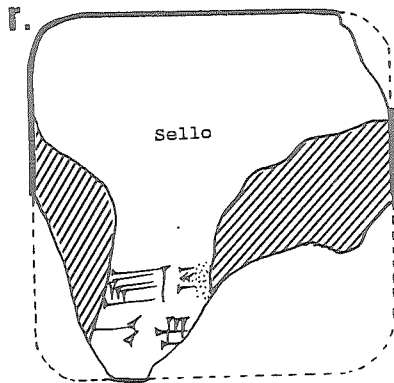
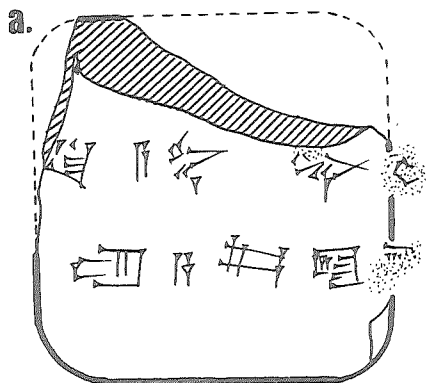

757 (MM 1161)

Umma
ŠS9/ii/-

757. Sello:

[A]-du
[dub-sar]
[dumu Lu₂-ga]

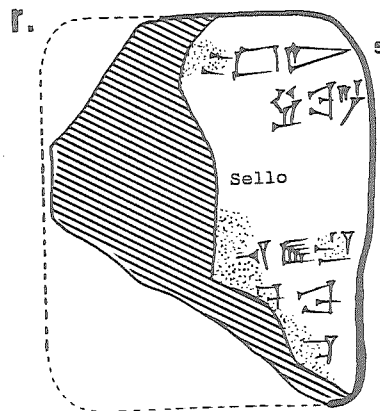
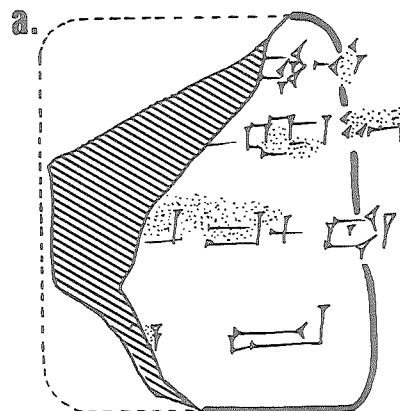

758 (MM 1162)

Umma
Š45 6 AS2/x/-

758. Sello:

Lu₂/Lugal-[...]
dub-sar
dumu Lugal-a₂-zi-da

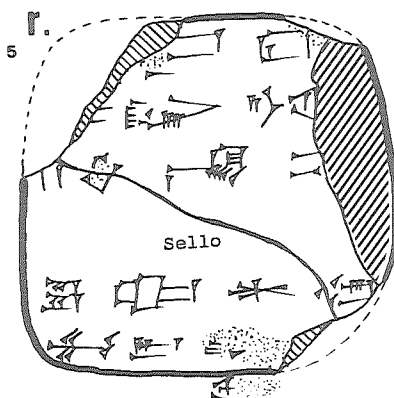
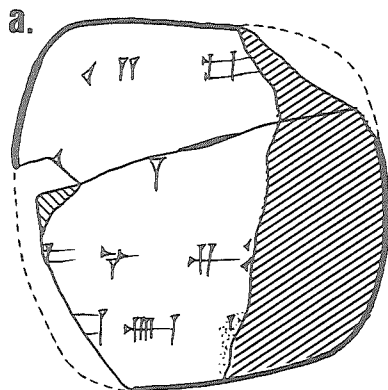

759 (MM 1163)

Umma
ŠS1/v/[-?]

759. Sello:

[A]-kal-¹la²
[dumu] ¹Lu₂-bulu₃-ga₂²
ašgab [gal]

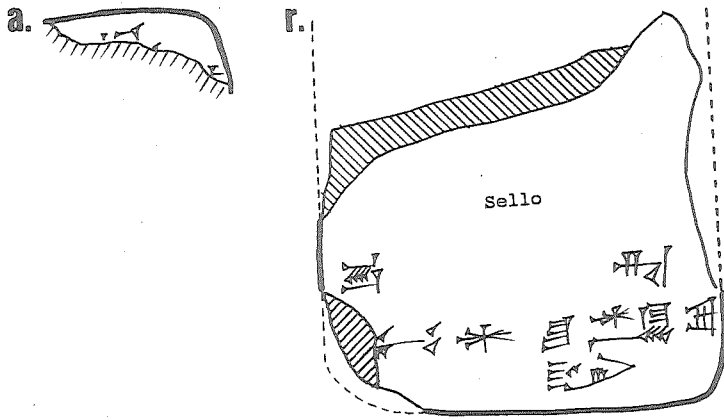

762 (MM 1166) 762. Sello:

Umma
AS5/-

A-ka[-la]
dub-[sar]
d[umu] ¹Lu₂-¹Lugal²-[...]

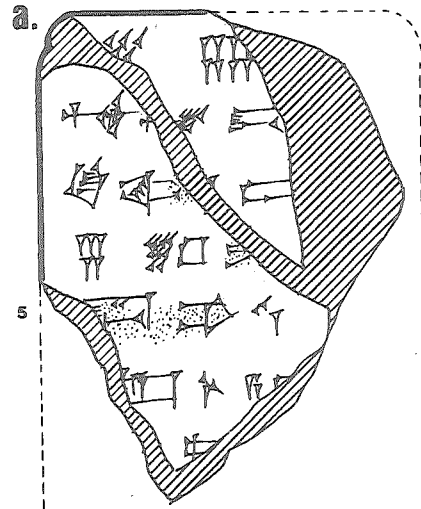

760 (MM 1164)

Umma
[]/xiii/-

760. Sello:

[...]
[dub]-sar
[dumu Ha-ba]-lu₅-/ge₂ [...]

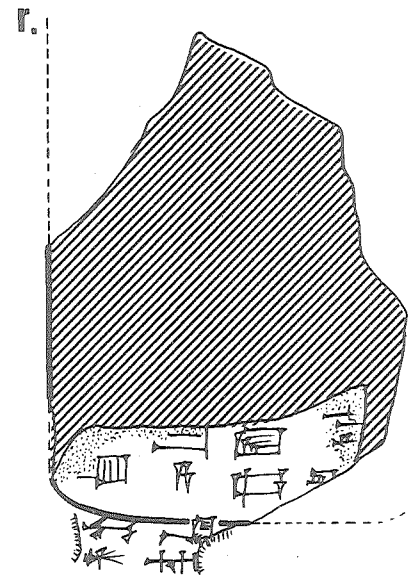
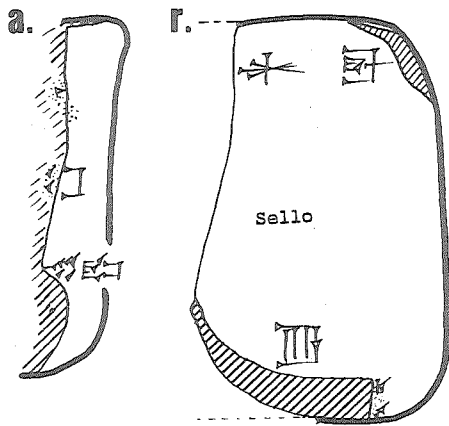

761 (MM 1165)

Umma
Š41/vi-[-]/-

761. Sello:

Ša₂-ku₂-ge
dumu ⁴Sara₂-[...]

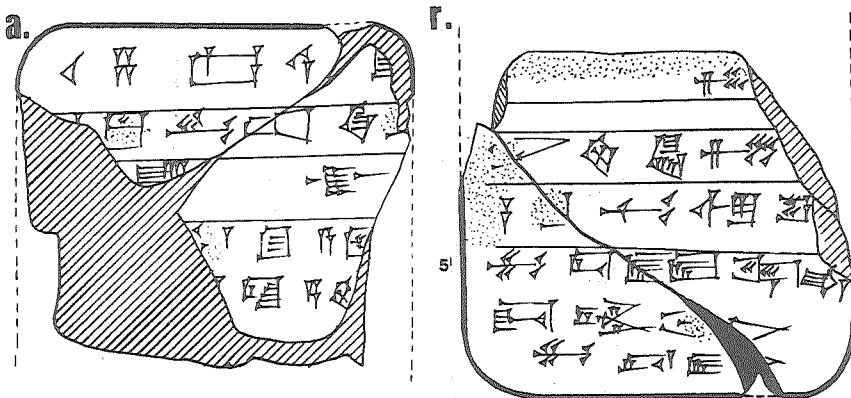

763 (MM 1167)

Tablilla demasiado destruida para copia

764 (MM 1168)

Tablilla demasiado destruida para copia

765 (MM 1169)

Tablilla demasiado destruida para copia

MATERIALI PER IL VOCABOLARIO NEOSUMERICO

Volumi pubblicati:

- I - PETTINATO, G. - WAETZOLDT, H. - *La collezione Schollmeyer*. Edizione Roma 1974, pp. 32 + 70 tavv. Brossura.
- II - SAUREN, H. - *Wirtschaftsurkunden des Musée d'Art et d'Histoire in Genf*. Edizione Roma 1975, pp. 32 + 139 tavv. Brossura.
- III - OWEN, D. - *The John Frederick Lewis Collection*. Edizione Roma 1975, pp. 60 + 125 tavv. Brossura.
- IV - CAGNI, L. PETTINATO, G. - *Le collezioni del Biblico e di Aosta*. Edizione Roma 1976, pp. 126. Brossura.
- V - SOLLBERGER, E. - *The Prinches Manuscript*. Edizione Roma 1978, pp. 26 + 78 tavv. Brossura.
- VI - PETTINATO, G. - *Testi economici di Lagaš del Museo di Istanbul - Parte I: La. 7001-7600*. Edizione Roma 1977, pp. 420. Brossura.
- VII - PETTINATO, G. - PICCHIONI, S. A. - *Testi economici di Lagaš del Museo di Istanbul - Parte II: La. 7601-8200*. Edizione Roma 1978, pp. 236. Brossura.
- VIII - CALVOT, D. - *Textes économiques du Selluš-Dagan du Musée du Louvre et du College de France*.
G. PETTINATO - S. A. PICCHIONI - F. RESHIND - *Testi economici dell'Iraq Museum Baghdad* - Edizione Roma 1979, pp. 120. Brossura.
- IX - SNELL, D. - *The E. A. Hoffman Collection and other american collections*. Edizione Roma 1979, pp. 150. Brossura.
- X - GRÉGOIRE, J.P. - *Inscriptions et archives administratives cunéiformes - I^e Partie* - Edizione Roma 1981, pp. 180. Brossura.
- XI - OWEN, D. - *Selected UR III Texts from the Harward Semitic Museum* - Edizione Roma 1982, pp. 100. Brossura.
- XII - TOHRU GOMI - *Wirtschaftstexte der UR III - Zeit aus dem British Museum* - Edizione Roma 1982, pp. 256. Brossura.
- XIII - SIGRIST, M. - OWEN, D. - YOUNG, G.D. - *The John Frederick Lewis Collection - Parte II*. Edizione Roma 1984, pp. 36 + 155 tavv. Brossura.
- XIV - YILDIZ, F. - WAETZOLDT, H. - REUNER, H. - *Die Umma-Texte aus den Archäologischen Museen zu Istanbul*. Nr. 1-600. Edizione Roma 1988, pp. 168. Brossura.
- XV - OWEN, D. - *Neo-Sumerian Texts from American Collections*. Edizione Roma 1991, pp. 280. Brossura.
- XVI - *(In preparazione)*.
- XVII - PETTINATO, G. - *Testi economici Neo-Sumerici del British Museum (BM 12230-BM 12390)*. Edizione Roma 1993, pp. 144. Brossura.